



双闪存引脚电子测量/高压开关矩阵

MAX9960

概述

MAX9960双路闪存引脚电子/高压开关矩阵可替代闪存或SOC ATE系统(图1)中用来连接系统信号源与两个引脚的继电器和开关。器件每通道可提供7个开关,最多选择4个独立源:引脚电子(PE)、两路参数测量单元(PMU)或其它开尔文模拟信号源、一路闪存编程高压(FV_{HH})。PMU加载和感应开关可独立控制,用于连接两路非开尔文源,替代PMU或开尔文源。MAX9960两个通道中的每一通道均包括可完全独立控制的7路开关。

MAX9960信号通道中的开关在通用引脚电子测量IC的整个电压范围内具有600MHz带宽、低至3Ω的串联电阻和低至8pF的并联电容。片内1倍或2倍增益可选的缓冲器产生闪存高压,由6.5V DAC基准输入产生最大13V的闪存编程电压。

当从FV_{HH}切换到PE_或者从PE_切换到FV_{HH}时,被测器件(DUT_)电压具有单调性。PE_和FV_{HH}输入切换时间通常小于350ns。

MAX9960工作在0°C至+70°C商业级温度范围,提供48引脚、薄型QFN封装(7mm x 7mm x 0.8mm),封装底部带有裸露焊盘,有助于散热。

应用

闪存存储器自动测试设备
SOC自动测试设备

特性

- ◆ 双路高压开关矩阵
- ◆ 3Ω、8pF、600MHz带宽的引脚电子测量通道
- ◆ 13V闪存编程通道
- ◆ 内部选择1倍或2倍增益
- ◆ 两个开尔文PMU通道
- ◆ 快速切换: 350ns (典型值)
- ◆ PE_和FV_{HH}_之间切换时具有单调摆率

订购信息

PART	TEMP RANGE	PIN-PACKAGE*	PKG CODE
MAX9960BCTM	0°C to +70°C	48 Thin QFN-EP** (7mm x 7mm x 0.8mm)	T4877-6

* 详细的封装信息请参考本数据资料的最后部分。

** EP = 裸露焊盘。

引脚配置

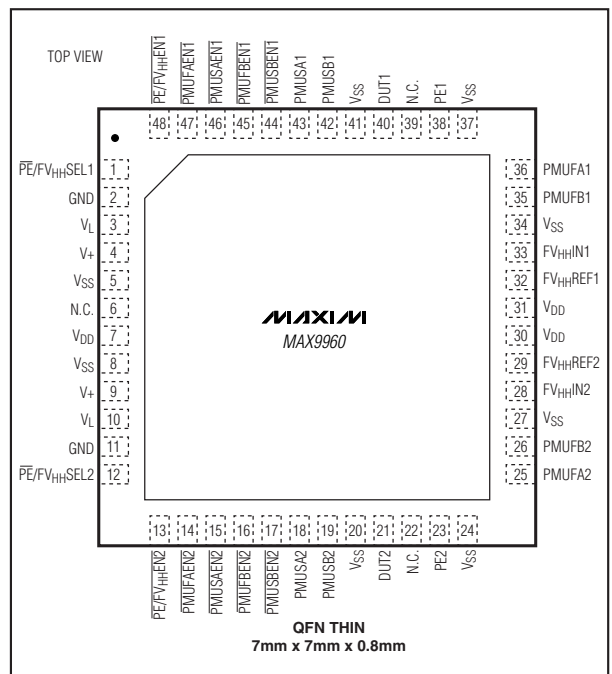

Maxim Integrated Products 1

本文是Maxim正式英文资料的译文,Maxim不对翻译中存在的差异或由此产生的错误负责。请注意译文中可能存在文字组织或翻译错误,如需确认任何词语的准确性,请参考Maxim提供的英文版资料。

索取免费样品和最新版的数据资料,请访问Maxim的主页: www.maxim-ic.com.cn。

双闪存引脚电子测量/高压开关矩阵

MAX9960

ABSOLUTE MAXIMUM RATINGS

V+ to GND	-0.3V to +26V	Peak Current (100ns), PE_	±300mA
VDD to GND	-0.3V to +16.5V	Peak Current (100ns), PMUS_	±20mA
VSS to GND	-6.5V to +0.3V	Peak Current (100ns), PMUFA_ + PMUFB_ + (FVHH_ Path)	±70mA
VL to GND	-0.3V to +6V	Package Continuous Power Dissipation (TA = +70°C) 48-Pin QFN-EP, on Single-Layer Board (derate 27.8mW/°C above +70°C)	2222mW
V+ to VSS	+32V	48-Pin QFN-EP, on Multilayer Board (derate 40.0mW/°C above +70°C)	3200mW
Digital Inputs	(GND - 0.3V) to (VL + 0.3V)	Operating Temperature Range	0°C to +70°C
FVHHIN_	(the higher of -4V and (VSS - 0.3V)) to (the lower of +10V and (VDD + 0.3V))	Junction Temperature	+150°C
All Other Pins	(VSS - 0.3V) to (VDD + 0.3V)	Storage Temperature Range	-65°C to +150°C
Continuous Current, PE_	±120mA	Lead Temperature (soldering 10s)	+300°C
Continuous Current, PMUS_	±10mA		
Continuous Current, PMUFA_ + PMUFB_ + (FVHH_ Path)	±45mA		

Stresses beyond those listed under "Absolute Maximum Ratings" may cause permanent damage to the device. These are stress ratings only, and functional operation of the device at these or any other conditions beyond those indicated in the operational sections of the specifications is not implied. Exposure to absolute maximum rating conditions for extended periods may affect device reliability.

ELECTRICAL CHARACTERISTICS

(V+ = +24V, VDD = +15V, VSS = -5V, VL = +3.3V, TA = +25°C, unless otherwise noted. Specifications at TA = 0°C and TA = +70°C are guaranteed by design and characterization. Typical values are at TA = +25°C, unless otherwise noted.) (Figure 1)

PARAMETER	SYMBOL	CONDITIONS	MIN	TYP	MAX	UNITS
DC CHARACTERISTICS						
PE_ PATH						
On-Resistance	RON	V _{DUT_} = +2.5V, I _{sw} = -40mA to +40mA, TA = 0°C to +30°C (Note 1)	2.5	3.0	3.5	Ω
		V _{DUT_} = +2.5V, I _{sw} = -40mA to +40mA, TA = +30°C to +70°C (Note 1)	2.5		4.2	
On-Resistance Flatness	R _{FLAT(ON)}	V _{DUT_} = 0 to +5V (Note 1)	-0.6		+0.6	Ω
Ch1 to Ch2 Resistance Match	R _{MATCH}	V _{DUT_} = +2.5V, I _{sw} = -40mA to +40mA	-0.5		+0.5	Ω
Signal Voltage Range	V _{PE}		-3.5		+8.0	V
Operating DC Current Range	I _{sw}		-40		+40	mA
FVHH_ PATH						
On-Resistance	RON	FV _{HH_} = -1.5V to (V _{DD} - 1.5V), I _{HH_} = -10mA to +10mA (Notes 1, 2)	32		100	Ω
Operating Voltage Range	FV _{HH_}		-1.5		V _{DD} - 1.5	V
Operating DC Current Range	I _{sw}		-10		+10	mA
FORCE PATHS						
On-Resistance	RON	V _{PMUF_} = -4.25V to +14.5V, I _{PMUF_} = -25mA to +25mA (Note 1)			70	Ω
Operating Voltage Range	V _{PMUF}		-4.25		+14.5	V
Operating DC Current Range	I _{sw}		-25		+25	mA
SENSE PATHS						
On-Resistance	RON	V _{PMUS_} = -4.25V to +14.5V, I _{PMUS_} = -1mA to +1mA (Note 1)			1250	Ω

双闪存引脚电子测量/高压开关矩阵

ELECTRICAL CHARACTERISTICS (continued)

(V+ = +24V, V_{DD} = +15V, V_{SS} = -5V, V_L = +3.3V, T_A = +25°C, unless otherwise noted. Specifications at T_A = 0°C and T_A = +70°C are guaranteed by design and characterization. Typical values are at T_A = +25°C, unless otherwise noted.) (Figure 1)

PARAMETER	SYMBOL	CONDITIONS	MIN	TYP	MAX	UNITS
Operating Voltage Range	V _{PMUS}		-4.25		+14.5	V
Operating DC Current Range	I _{sw}		-1		+1	mA
FV_{HH}_ BUFFERS						
DC Output Current	I _{ODC}	FV _{HH} = -1.5V to (V _{DD} - 1.5V)	10			mA
Current Limit	I _{LIM}	DUT_ sourcing current	+15		+25	mA
		DUT_ sinking current	-25		-15	mA
Operating Voltage Range	FV _{HH}	FV _{HHREF} = 0 (Note 2)	-1.5		V _{DD} - 1.5V	V
Linearity Error	LER _{FVHH}	FV _{HHREF} = 0; no load; relative to 2-point line between V _{DUT} = 0 and +13V; measured at V _{DUT} = +3.25V, +6.5V, and +9.75V	-2		+2	mV
Gain	GFV _{HH}	FV _{HHREF} = 0, no load, V _{DUT} = 0 to +13V (Note 3)	1.98	2.00	2.02	V/V
Output Offset	V _{OS_FVHH}	FV _{HHREF} = 0, V _{DUT} = +12V, no load	-50		+50	mV
Output Offset Temperature Coefficient	T _{C_VOS}	V _{DUT} = 0 to +13V, FV _{HHREF} = 0, T _{CASE} = +30°C to +50°C		±0.2		mV/°C
Input Bias Current	IFV _{HH}	FV _{HHIN} = -1.5V to +7.5V, FV _{HHREF} = open	-25		+25	μA
Gain Resistor Ground	FV _{HHREF}	(Note 4)	-1.5		+0.5	V
Gain Resistor Current	I _{VHHREF}	Measured with FV _{HHIN} = +5V, FV _{HHREF} = 0		0.4		mA
LEAKAGE (Notes 5, 6)						
DUT_ Leakage, Disabled	I _{LEAK_OFF}	Switches S1, S2, S6, S7 open; V _{DUT} = -4.25V to +14.5V	-1		+1	nA
PE_ Leakage	I _{LEAK_PE}	S1 closed; S2, S6, S7 open; V _{DUT} = -3.5V to +8V	-1		+1	nA
PMUA_ Path Leakage, Enabled	I _{LEAK_PMU_A_ON}	S2, S4, S6 closed; S1, S3, S5, S7 open; V _{DUT} = -4.25V to +14.5V	-1		+1	nA
PMUB_ Path Leakage, Enabled	I _{LEAK_PMU_B_ON}	S2, S5, S7 closed; S1, S3, S4, S6 open; V _{DUT} = -4.25V to +14.5V	-1		+1	nA
PMUA_ Path Leakage, Disabled	I _{LEAK_PMU_A_OFF}	S4, S6 open; V _{PMUFA} = -4.25V to +14.5V; measured at PMUFA_ with PMUSA_ externally connected to PMUFA_	-1		+1	nA
PMUB_ Path Leakage, Disabled	I _{LEAK_PMU_B_OFF}	S5, S7 open; V _{PMUFB} = -4.25V to +14.5V; measured at PMUFB_ with PMUSB_ externally connected to PMUFB_	-1		+1	nA
DIGITAL INPUTS (PMUF_EN_, PMUS_EN_, PE/FV_{HHEN}_, PE/FV_{HHSEL}_)						
Input High Voltage	V _{IH}		+2.3			V
Input Low Voltage	V _{IL}				+0.4	V

双闪存引脚电子测量/高压开关矩阵

MAX9960

ELECTRICAL CHARACTERISTICS (continued)

(V+ = +24V, V_{DD} = +15V, V_{SS} = -5V, V_L = +3.3V, T_A = +25°C, unless otherwise noted. Specifications at T_A = 0°C and T_A = +70°C are guaranteed by design and characterization. Typical values are at T_A = +25°C, unless otherwise noted.) (Figure 1)

PARAMETER	SYMBOL	CONDITIONS	MIN	TYP	MAX	UNITS
Input Voltage Range	V _{IN}		-0.2		V _L	V
Input Current	I _{IH} , I _{IL}	V _{IN} = -0.2V to V _L	-10		+10	μA
POWER SUPPLIES						
Positive Supply	V _{DD}		14.5	15	16.0	V
Negative Supply	V _{SS}		-6.00	-5	-4.25	V
High Voltage Supply	V+	(Note 1)	23	24	25	V
Logic Supply	V _L		3.0	3.3	3.6	V
Quiescent Positive Supply Current	Σ (I _{DD} , I+)	V+ = +24V, V _{DD} = +15V, V _{SS} = -5V, V _L = +3.3V, FV _{HHL} _{IN} = +6.5V, FV _{HHL} _{REF} = 0, all digital inputs = +2.3V, no loads			10	mA
Quiescent Negative Supply Current	I _{SS}	V+ = +24V, V _{DD} = +15V, V _{SS} = -5V, V _L = +3.3V, FV _{HHL} _{IN} = +6.5V, FV _{HHL} _{REF} = 0, all digital inputs = +2.3V, no loads			8.5	mA
Quiescent Logic Supply Current	I _{VL}	V+ = +24V, V _{DD} = +15V, V _{SS} = -5V, V _L = +3.3V, FV _{HHL} _{IN} = +6.5V, FV _{HHL} _{REF} = 0, all digital inputs = +2.3V, no loads			2	mA
Quiescent Power Dissipation	P _{DQ}	V+ = +24V, V _{DD} = +15V, V _{SS} = -5V, V _L = +3.3V, FV _{HHL} _{IN} = +6.5V, FV _{HHL} _{REF} = 0, all digital inputs = +2.3V, no loads			200	mW
AC CHARACTERISTICS						
SWITCHING TIMES BETWEEN PE₋ AND FV_{HHL} PATHS (Note 7) (Figure 3)						
Switch PE ₋ to FV _{HHL}	t _{ON_FVHH}	+5V to +7V transition		275	425	ns
		0 to +13V transition		350	500	
FV _{HHL} Settling Time	t _{S_FVHH}	Settling to within larger of 1% step voltage or 50mV of final value		500		ns
Switch FV _{HHL} to PE ₋	t _{ON_PE}			300	425	ns
PE ₋ Settling Time	t _{S_PE}	Settling to within larger of 1% step voltage or 50mV of final value		500		ns
PE ₋ to FV _{HHL} Overshoot/Undershoot				±100		mV
PE ₋ to FV _{HHL} Preshoot				±150		mV
Minimum Switching Slew Rate	SR _{MIN}	Over 20% to 80% region		±10		V/μs
SWITCHING TIMES, SAME PATH (Note 8) (Figure 2)						
PE ₋ Switch On-Time	t _{ON_1}	V _{PE} = +5V from 47Ω source		150		ns
FV _{HHL} Switch On-Time	t _{ON_2,3}	FV _{HHL} _{IN} = +2.5V, FV _{HHL} _{REF} = 0		350		ns

双闪存引脚电子测量/高压开关矩阵

ELECTRICAL CHARACTERISTICS (continued)

(V+ = +24V, V_{DD} = +15V, V_{SS} = -5V, V_L = +3.3V, T_A = +25°C, unless otherwise noted. Specifications at T_A = 0°C and T_A = +70°C are guaranteed by design and characterization. Typical values are at T_A = +25°C, unless otherwise noted.) (Figure 1)

PARAMETER	SYMBOL	CONDITIONS	MIN	TYP	MAX	UNITS
PMUF_ Switch On-Time	t _{ON_2,4} t _{ON_2,5}	V _{PMUF_} = +5V		150		ns
PMUS_ Switch On-Time	t _{ON_6} t _{ON_7}	V _{PMUS_} = +5V		300		ns
PE_ FV _{HH_} , PMUF_ , PMUS_ Switch Off-Times	t _{OFF}			700		ns
CAPACITANCE AND BANDWIDTH (Note 5)						
Capacitance, All Paths Disconnected	C _{DUT_OFF}	All switches disconnected, for frequencies greater than 2MHz (Note 9)		20		pF
Capacitance, PE_ Path Connected (Note 9)	C _{DUT_PE}	Switch S1 closed, all others open, for frequencies greater than 2MHz		8		pF
		Switch S1 closed, all others open, for frequencies less than 1kHz		50		
Unit-to-Unit Variation, PE_ Path Connected	ΔC _{DUT_PE}	Switch S1 closed, all others open, for frequencies greater than 2MHz (Note 9)		±2		pF
Capacitance, PMUFA_ and PMUSA_ Path Connected	C _{DUT_PMUA}	S2, S4, and S6 closed; all others open (Note 9)		35		pF
Capacitance, PMUFB_ and PMUSB_ Path Connected	C _{DUT_PMUB}	S2, S5, and S7 closed; all others open (Note 9)		35		pF
Capacitance, PMUFA_ Path Disconnected	C _{PMUFA_OFF}	S4 open, measured at PMUFA_ (Note 9)		10		pF
Capacitance, PMUFB_ Path Disconnected	C _{PMUFB_OFF}	S5 open, measured at PMUFB_ (Note 9)		10		pF
Capacitance, PMUSA_ Path Connected	C _{PMUSA_ON}	S6 closed, all others open, measured at PMUSA_ (Note 9)		10		pF
Capacitance, PMUSB_ Path Connected	C _{PMUSB_ON}	S7 closed, all others open, measured at PMUSB_ (Note 9)		10		pF
Capacitance, PMUSA_ Path Disconnected	C _{PMUSA_OFF}	S6 open, measured at PMUSA_ (Note 9)		5		pF
Capacitance, PMUSB_ Path Disconnected	C _{PMUSB_OFF}	S7 open, measured at PMUSB_ (Note 9)		5		pF
PE_ Signal Bandwidth	f _{3DB}	Only PE_ path enabled (Note 10)		600		MHz
FV_{HH_} BUFFER						
Slew Rate	SRFV _{HH}	FV _{HH} REF_ = 0, (gain = 2), FV _{HH} IN_ stepped from 0 to +5V and +5V to 0		±5		V/μs
Settling	t _s	C _{DUT_} = 200pF to within 0.1% of step voltage, after FV _{HH} IN_ changes		25		μs
		C _{DUT_} = 4000pF to within 0.1% of step voltage, after FV _{HH} IN_ changes (Note 11)		50		

双闪存引脚电子测量/高压开关矩阵

MAX9960

ELECTRICAL CHARACTERISTICS (continued)

($V_+ = +24V$, $V_{DD} = +15V$, $V_{SS} = -5V$, $V_L = +3.3V$, $T_A = +25^\circ C$, unless otherwise noted. Specifications at $T_A = 0^\circ C$ and $T_A = +70^\circ C$ are guaranteed by design and characterization. Typical values are at $T_A = +25^\circ C$, unless otherwise noted.) (Figure 1)

- Note 1:** V_+ should be at least 8V above V_{DD} to guarantee specified path resistance values.
- Note 2:** When the $FV_{HH_}$ buffer is configured for a gain of +1 ($FV_{HHREF_}$ open), the output voltage range is limited to -1.5V to +7.5V.
- Note 3:** $FV_{HH_}$ buffer gain is typically +1, when $FV_{HHREF_}$ is open.
- Note 4:** $FV_{HHREF_}$ is tested by repeating the $FV_{HH_}$ path resistance tests over the variation of $FV_{HHREF_}$. For each value of $FV_{HHREF_}$, $FV_{HHIN_}$ is adjusted to $FV_{HHIN_} = (FV_{HH_} + FV_{HHREF_}) / 2$.
- Note 5:** All measurements taken at $DUT_$, except where noted.
- Note 6:** These specifications are guaranteed by design and characterization. In addition, these specifications will be production tested with min/max test limits of $\pm 10nA$.
- Note 7:** Voltage source driving $PE_$ has 47Ω source resistance. $PE_ = 0$ to +5.0V, $FV_{HH_} = +7$ to +13V. Measured from 50% point of input logic to 90% of analog swing.
- Note 8:** All unused switches open, unless otherwise noted. Measured from 50% point of input logic to 90% of analog swing.
- Note 9:** Unless otherwise noted, measured at $DUT_$. No external connections to any of the switched analog pins— $PE_$, $DUT_$, $PMUFA_$, $PMUFB_$, $PMUSA_$, or $PMUSB_$ —except as needed to make measurement.
- Note 10:** $Z_{DUT_} = 50\Omega$; equivalent bandwidth calculated from measured $DUT_$ rise and fall time with $PE_$ stimulated by a 3V step with 1ns 10% to 90% rise/fall time.
- Note 11:** The maximum load for FV_{HH} buffer is 4000pF.

典型工作特性

($V_+ = +24V$, $V_{DD} = +15V$, $V_{SS} = -5V$, $V_L = +3.3V$, $T_A = +25^\circ C$, unless otherwise noted.)

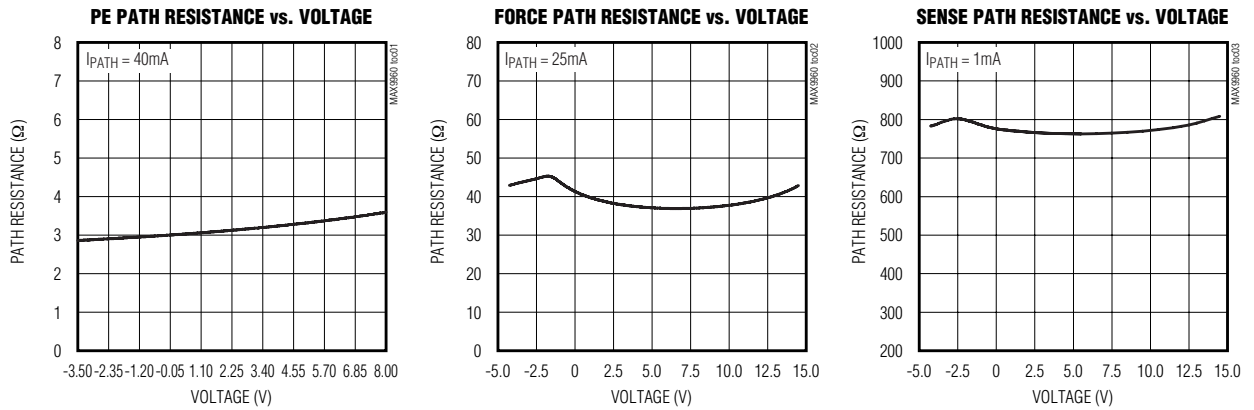

双闪存引脚电子测量/高压开关矩阵

典型工作特性 (续)

($V_+ = +24V$, $V_{DD} = +15V$, $V_{SS} = -5V$, $V_L = +3.3V$, $T_A = +25^\circ C$, unless otherwise noted.)

MAX9960

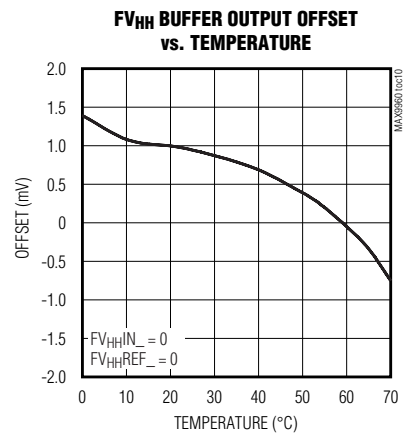
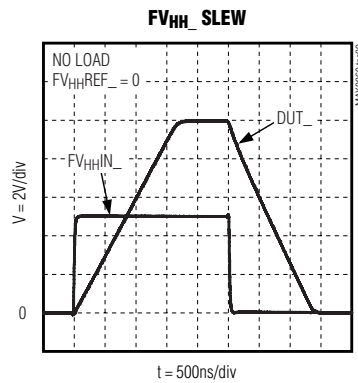
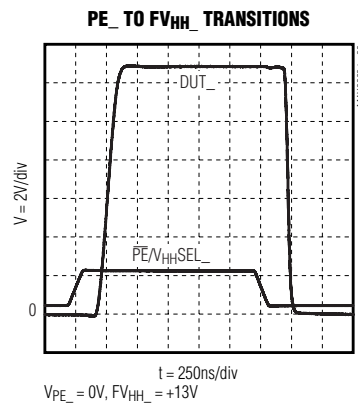
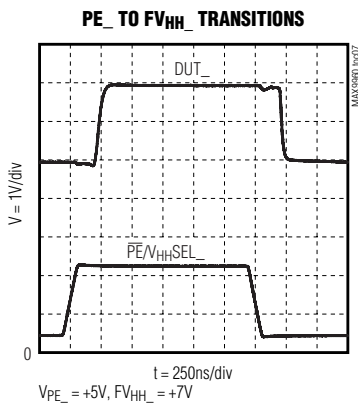
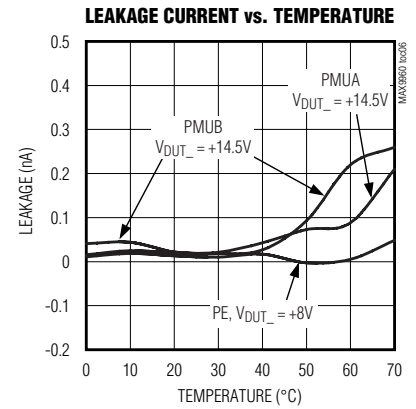
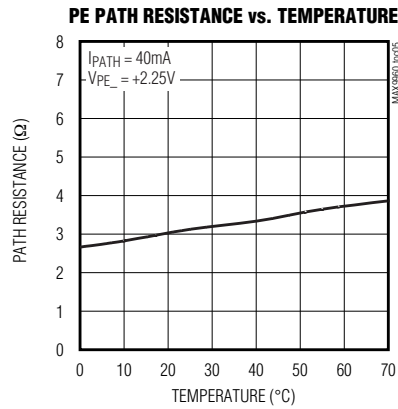
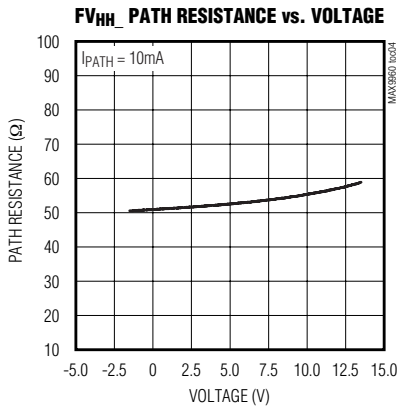

双闪存引脚电子测量/高压开关矩阵

MAX9960

引脚	名称	功能
1	$\overline{PE}/FV_{HH}SEL1$	PE1或 $FV_{HH}1$ 选择输入。选择PE1或者 $FV_{HH}1$ 连接至DUT1。接低电平时选择PE1，接高电平时选择 $FV_{HH}1$ 。
2, 11	GND	地
3, 10	V_L	逻辑电源。3.3V标称值。
4, 9	V_+	正模拟电源，用于栅极驱动。24V标称值。
5, 8, 20, 24, 27, 34, 37, 41	V_{SS}	负模拟电源。-5V标称值。
6, 22, 39	N.C.	无连接。不要连接该引脚。
7, 30, 31	V_{DD}	正模拟电源。15V标称值。
12	$\overline{PE}/FV_{HH}SEL2$	PE2或 $FV_{HH}2$ 选择输入。选择PE2或者 $FV_{HH}2$ 连接至DUT2。接低电平时选择PE2，接高电平时选择 $FV_{HH}2$ 。
13	$\overline{PE}/FV_{HH}EN2$	PE2和 $FV_{HH}2$ 使能控制。由 $\overline{PE}/FV_{HH}SEL2$ 选择将PE2或 $FV_{HH}2$ 连接至DUT2。接低电平时使能信号通路，接高电平时禁止信号通路。
14	$\overline{PMUFAEN2}$	PMUFA2使能控制。控制PMUFA2与DUT2之间的连接。接低电平时连接PMUFA2至DUT2，接高电平时断开PMUFA2与DUT2的连接。
15	$\overline{PMUSAEN2}$	PMUSA2使能控制。控制PMUSA2与DUT2之间的连接。接低电平时连接PMUSA2至DUT2，接高电平时断开PMUSA2与DUT2的连接。
16	$\overline{PMUFBEN2}$	PMUFB2使能控制。控制PMUFB2与DUT2之间的连接。接低电平时连接PMUFB2至DUT2，接高电平时断开PMUFB2与DUT2的连接。
17	$\overline{PMUSBEN2}$	PMUSB2使能控制。控制PMUSB2与DUT2之间的连接。接低电平时连接PMUSB2至DUT2，接高电平时断开PMUSB2与DUT2的连接。
18	PMUSA2	通道2检测A路模拟输出。通道2的开尔文反馈输出加载到A通路。
19	PMUSB2	通道2检测B路模拟输出。通道2的开尔文反馈输出加载到B通路。
21	DUT2	通道2模拟I/O。连接至DUT。
23	PE2	通道2模拟I/O。连接至引脚电子I/O。
25	PMUFA2	通道2加载A路模拟输入。连接至外部直流源，如PMU。
26	PMUFB2	通道2加载B路模拟输入。连接至外部直流源，如PMU。
28	$FV_{HH}IN2$	通道2模拟高压输入。对加载到 $FV_{HH}IN2$ 输入端的电压进行放大，增益由 $FV_{HH}REF2$ 决定(参考功能框图)。
29	$FV_{HH}REF2$	通道2模拟增益设置输入。设置 $FV_{HH}2$ 缓冲器增益。
32	$FV_{HH}REF1$	通道1模拟增益设置输入。设置 $FV_{HH}1$ 缓冲器增益。
33	$FV_{HH}IN1$	通道1模拟高压输入。对加载到 $FV_{HH}IN1$ 输入端的电压进行放大，增益由 $FV_{HH}REF1$ 决定(参考功能框图)。
35	PMUFB1	通道1加载B路模拟输入。连接至外部直流源，如PMU。
36	PMUFA1	通道1加载A路模拟输入。连接至外部直流源，如PMU。
38	PE1	通道1模拟I/O。连接至引脚电子测量I/O。
40	DUT1	通道1模拟I/O。连接至DUT。
42	PMUSB1	通道1感应B路模拟输出。通道1的开尔文反馈输出加载到B通路。
43	PMUSA1	通道1感应A路模拟输出。通道1的开尔文反馈输出加载到A通路。

双闪存引脚电子测量/高压开关矩阵

引脚说明 (续)

MAX9960

引脚	名称	功能
44	$\overline{\text{PMUSBEN1}}$	PMUSB1使能控制。控制PMUSB1与DUT1之间的连接。接低电平时连接PMUSB1至DUT1，接高电平时断开PMUSB1与DUT1的连接。
45	$\overline{\text{PMUFBEN1}}$	PMUFB1使能控制。控制PMUFB1与DUT1之间的连接。接低电平时连接PMUFB1至DUT1，接高电平时断开PMUFB1与DUT1的连接。
46	$\overline{\text{PMUSAEN1}}$	PMUSA1使能控制。控制PMUSA1与DUT1之间的连接。接低电平时连接PMUSA1至DUT1，接高电平时断开PMUSA1与DUT1的连接。
47	$\overline{\text{PMUFAEN1}}$	PMUFA1使能控制。控制PMUFA1与DUT1之间的连接。接低电平时连接PMUFA1至DUT1，接高电平时断开PMUFA1与DUT1的连接。
48	$\overline{\text{PE/FV}_{\text{HH}}\text{EN1}}$	PE1和FV _{HH} 1使能控制。由 $\overline{\text{PE/FV}_{\text{HH}}\text{SEL1}}$ 选择PE1或FV _{HH} 1连接至DUT1。接低电平时使能信号通路，接高电平时禁止信号通路。
—	EP	裸露焊盘用于散热。内部偏置到V _{SS} 。连接至V _{SS} 或浮空。



图1. 功能框图

详细说明

MAX9960双通道模拟开关矩阵具有两个开尔文PMU通路、一个PE通路和一个闪存编程高压电路，可采用标准PE器件对闪存存储器进行测试。该器件在不使用继电器的条件下，可实现AC和DC的全功能引脚测量。

信号通路开关在通用引脚电子测量IC的整个电压范围内具有600MHz带宽、3Ω串联电阻和8pF并联电容。倍压缓冲器提供可选的1倍或2倍增益，能够从6.5V输入产生13V闪存存储器编程电压。可使用数字输入 $\overline{\text{PMUFAEN}}_1$ 、 $\overline{\text{PMUSAEN}}_1$ 、 $\overline{\text{PMUFBEN}}_1$ 、 $\overline{\text{PMUSBEN}}_1$ 、 $\overline{\text{PE/FV}_{\text{HH}}\text{EN}}_1$ 和 $\overline{\text{PE/FV}_{\text{HH}}\text{SEL}}_1$ 对开关进行设置，如表1、表2所示。

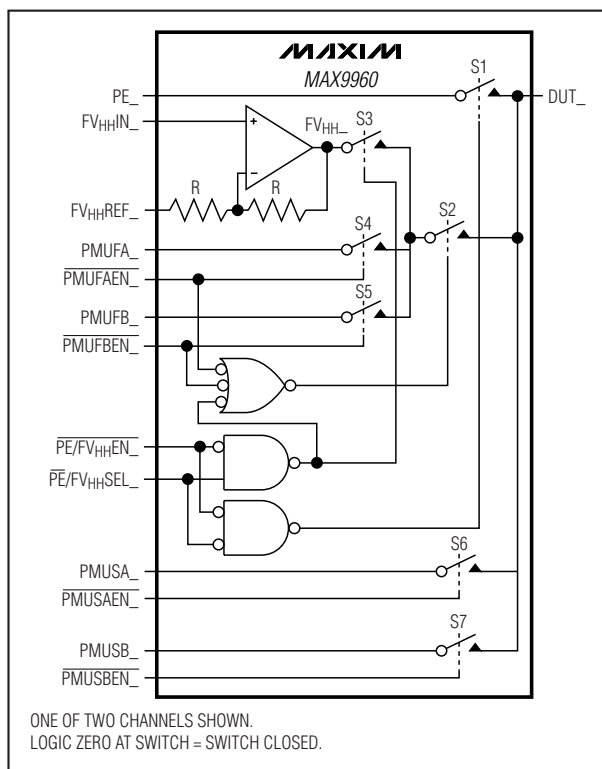
PE₁和FV_{HH}₁通路的切换时间通常小于350ns (图3)，切换期间DUT₁具有单调特性。

FV_{HH}缓冲器负载电容

FV_{HH}缓冲器的最大负载电容为4000pF。正常工作时，不会有如此大的负载电容。偶尔进行校准时，可能需要缓冲器连接至具有大容量负载的PMU通道。即使在这种情况下，也不会损坏MAX9960。

超高压FV_{HH}缓冲器增益

可利用FV_{HH}REF₁来选择FV_{HH}缓冲器的增益。FV_{HH}REF₁接地时，缓冲器的增益为+2。FV_{HH}REF₁浮空时，缓冲器的增益为+1。

双闪存引脚电子测量/高压开关矩阵

MAX9960

表1. 开关控制的所有可能组合

PMUFAEN ₋	PMUFBEN ₋	PMUSAEN ₋	PMUSBEN ₋	PE/FVHHEN ₋	PE/FVHHSEL ₋	DUT ₋
0	X	X	X	X	X	PMUFA ₋ path connected
X	0	X	X	X	X	PMUFB ₋ path connected
X	X	0	X	X	X	PMUSA ₋ path connected
X	X	X	0	X	X	PMUSB ₋ path connected
X	X	X	X	0	1	FVHH ₋ path connected
X	X	X	X	0	0	PE ₋ path connected
All other combinations						Every path is disconnected

表2. 开关控制和应用实例

PMUFAEN ₋	PMUFBEN ₋	PMUSAEN ₋	PMUSBEN ₋	PE/FVHHEN ₋	PE/FVHHSEL ₋	DUT ₋
1	1	1	1	0	0	PE ₋
1	1	1	1	0	1	FVHH ₋
0	1	0	1	1	X	PMUFA ₋ + PMUSA ₋
1	0	1	0	1	X	PMUFB ₋ + PMUSB ₋
0	1	0	1	0	0	PE ₋ + PMUFA ₋ + PMUSA ₋
1	0	1	0	0	0	PE ₋ + PMUFB ₋ + PMUSB ₋
0	1	0	1	0	1	FVHH ₋ + PMUFA ₋ + PMUSA ₋
1	0	1	0	0	1	FVHH ₋ + PMUFB ₋ + PMUSB ₋
0	0	0	0	0	0	PE ₋ + PMUFA ₋ + PMUSA ₋ + PMUFB ₋ + PMUSB ₋

电源注意事项

MAX9960要求提供4种电源电压，典型值分别为V₊ = +24V、V_{DD} = +15V、V_{SS} = -5V以及V_L = +3.3V。靠近每个电源引脚安装一个0.1μF的旁路电容，在电源进入电路板的位置应安装大容量旁路电容。MAX9960不需要任何特定的上电顺序。

芯片信息

TRANSISTOR COUNT: 2020
PROCESS: BICMOS

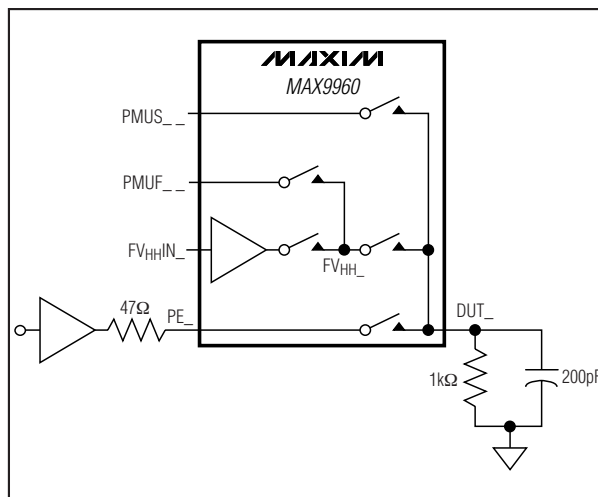

图2. 开关时序测试电路