

PACKAGE DIMENSIONS

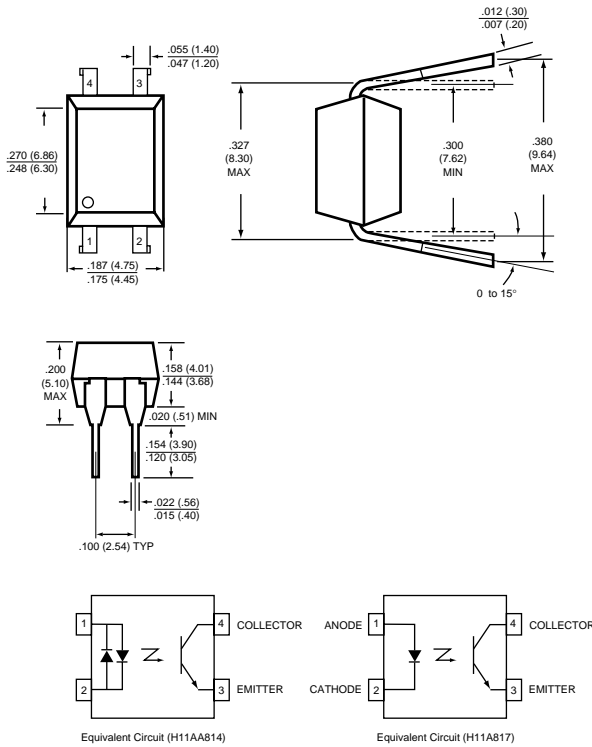

NOTE: ALL DIMENSIONS ARE IN INCHES (mm)
PACKAGE CODE T

DESCRIPTION

The QT Optoelectronics H11AA814 Series consists of two gallium arsenide infrared emitting diodes, connected in inverse parallel, driving a single silicon phototransistor in a 4-pin dual in-line package.

The H11A817 Series consists of a gallium arsenide infrared emitting diode driving a silicon phototransistor in a 4-pin dual in-line package.

FEATURES

- Compact 4-pin package
- Current transfer ratio in selected groups:

H11AA814:	20-300%	H11A817:	50-600%
H11AA814A:	50-150%	H11A817A:	80-160%
		H11A817B:	130-260%
		H11A817C:	200-400%
		H11A817D:	300-600%

APPLICATIONS

- H11AA814 Series
- AC line monitor
 - Unknown polarity DC sensor
 - Telephone line interface
- H11A817 Series
- Power supply regulators
 - Digital logic inputs
 - Microprocessor inputs
 - Industrial controls

ABSOLUTE MAXIMUM RATING

TOTAL PACKAGE

Storage temperature -55° to 150° C
 Operating temperature -55° to 100° C
 Lead solder temperature 260° C for 10 sec
 Power dissipation 200 mW

INPUT DIODE

Power dissipation (25° C ambient) 70 mW
 Derate linearly (above 25° C) 1.33 mW/° C
 Continuous forward current 50 mA
 Peak forward current (1 μs pulse, 300 pps) 1 A
 Reverse voltage (H11A817) 5 V

OUTPUT TRANSISTOR

Power dissipation (25° C ambient) 150 mW
 Derate linearly (above 25° C) 2.0 mW/° C
 V_{CEO} 35 V
 V_{ECO} 6 V
 Continuous collector current 50 mA

ELECTRO-OPTICAL CHARACTERISTICS ($T_A = 25^\circ\text{C}$ Unless otherwise specified)

INDIVIDUAL COMPONENT CHARACTERISTICS (Applies to all unless indicated otherwise)

PARAMETER	SYMBOL	MIN	TYP	MAX	UNITS	TEST CONDITIONS
INPUT DIODE						
Forward voltage						
H11A817	V_F		1.2	1.5	V	$I_F = 20\text{ mA}$
H11AA814	V_F		1.2	1.5	V	$I_F = \pm 20\text{ mA}$
Reverse current						
H11A817	I_R		.001	10	μA	$V_R = 5\text{ V}$
OUTPUT TRANSISTOR						
Breakdown voltage						
Collector to emitter	BV_{CEO}	35	100		V	$I_C = 1\text{ mA}, I_F = 0$
Emitter to collector	BV_{ECO}	6	10		V	$I_E = 100\ \mu\text{A}, I_F = 0$
Collector dark current	I_{CEO}		.025	100	nA	$V_{CE} = 10\text{ V}, I_F = 0$
Capacitance	C_{CE}		8		pF	$V_{CE} = 0\text{ V}, f = 1\text{ MHz}$

TRANSFER CHARACTERISTICS

CHARACTERISTIC	SYMBOL	MIN	TYP	MAX	UNITS	TEST CONDITIONS
DC current transfer ratio						
H11AA814	CTR	20		300	%	$I_F = \pm 1\text{ mA}, V_{CE} = 5\text{ V}$
H11AA814A	CTR	50		150	%	$I_F = \pm 1\text{ mA}, V_{CE} = 5\text{ V}$
H11A817	CTR	50		600	%	$I_F = 5\text{ mA}, V_{CE} = 5\text{ V}$
H11A817A	CTR	80		160	%	
H11A817B	CTR	130		260	%	
H11A817C	CTR	200		400	%	
H11A817D	CTR	300		600	%	
Saturation Voltage	$V_{CE(SAT)}$		0.1	0.2	V	$I_F = (\pm)20\text{ mA}, I_C = 1\text{ mA}$
Rise time (non saturated)	t_r		2.4	18	μs	$I_C = 2\text{ mA}, V_{CE} = 2\text{ V}, R_L = 100\ \Omega$
Fall time (non saturated)	t_f		2.4	18	μs	$I_C = 2\text{ mA}, V_{CE} = 2\text{ V}, R_L = 100\ \Omega$

ISOLATION CHARACTERISTICS

CHARACTERISTIC	SYMBOL	MIN	TYP	MAX	UNITS	TEST CONDITIONS
Steady-state isolation voltage	V_{ISO}	5300			V_{RMS}	1 Minute
Isolation resistance	R_{ISO}	10^{11}			Ω	$V_{I-O} = 500\text{ VDC}$
Isolation capacitance	C_{ISO}		0.5		pF	$V_{I-O} = \emptyset, f = 1\text{ MHz}$

TYPICAL CHARACTERISTICS

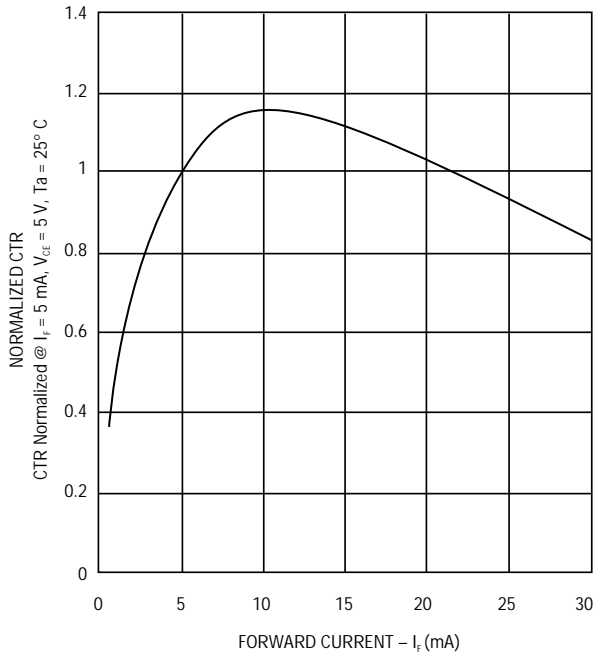

FIG. 1 - Normalized CTR vs. Forward Current

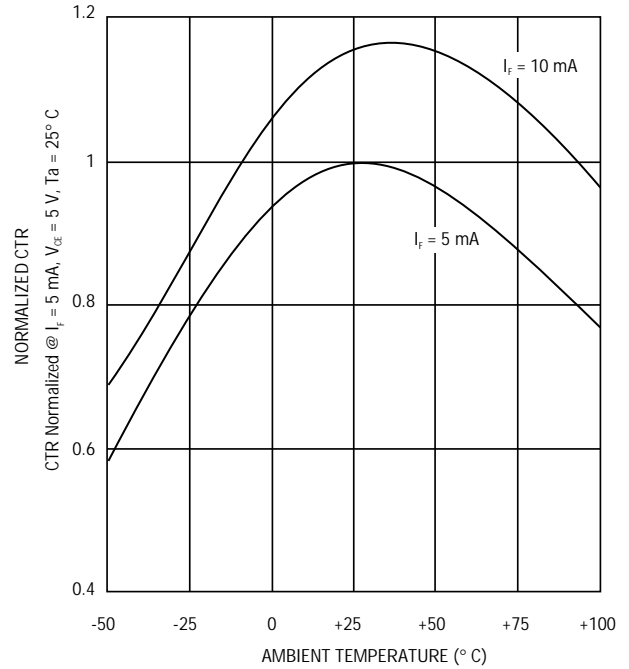

FIG. 2 - Normalized CTR vs. Ambient Temperature

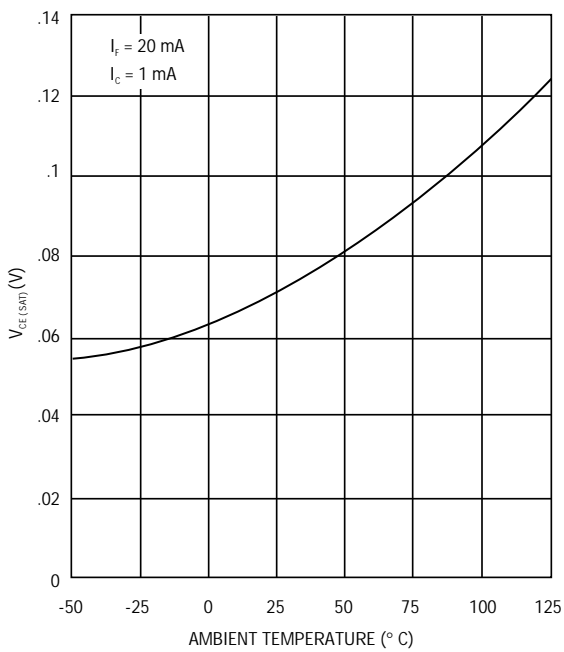

FIG. 3 - $V_{CE(SAT)}$ vs. Ambient Temperature

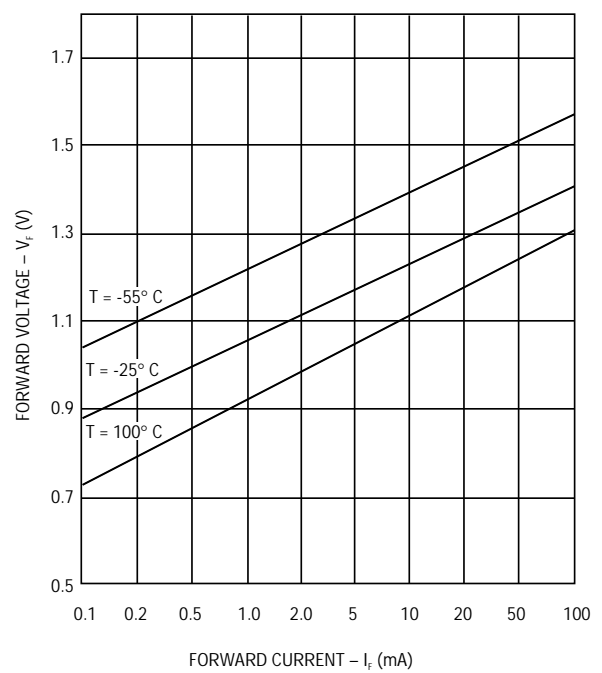

FIG. 4 - Forward Voltage vs. Forward Current

TYPICAL CHARACTERISTICS

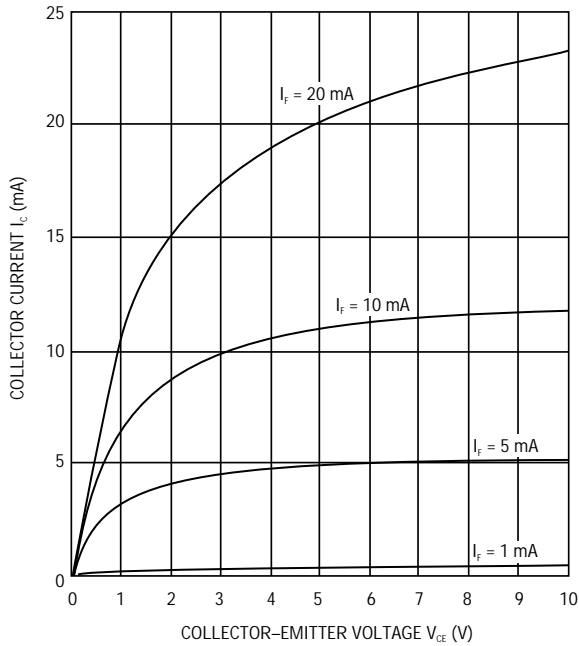

FIG. 5 - Collector Current vs. Collector-Emitter Voltage

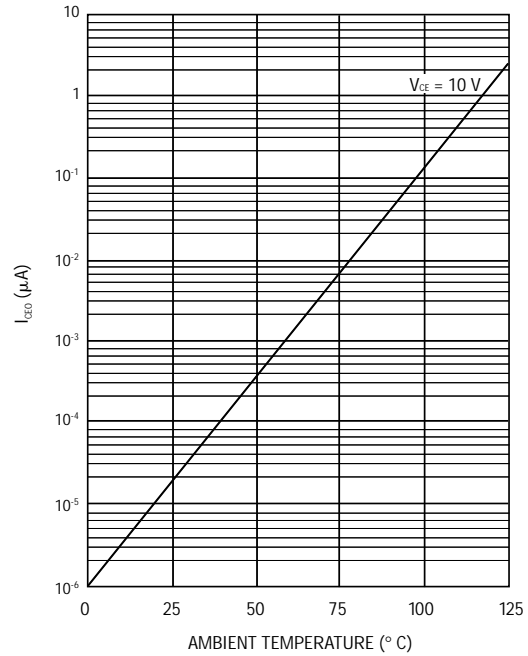

FIG. 6 - Collector Leakage Current vs. Ambient Temperature

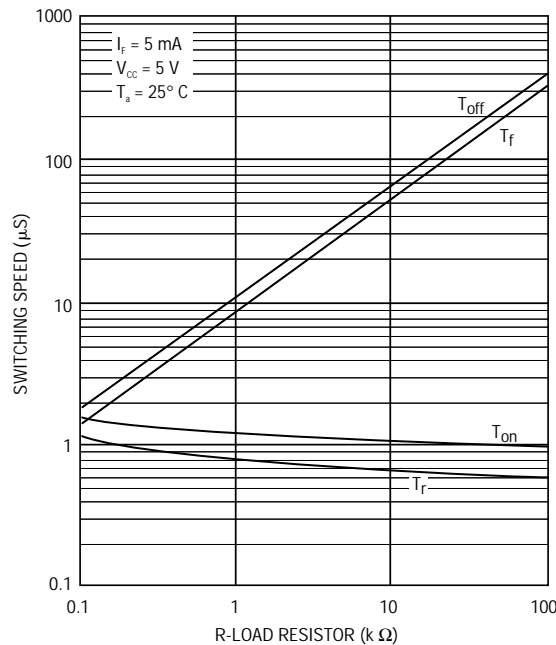

FIG. 7 - Switching Speed vs. Load Resistor (TYP)

Call QT Optoelectronics for more information or the phone number of your nearest distributor.

United States 800-533-6786 • France 33 01/43.99.25.12 • Germany 49 089/96.30.51 • United Kingdom 44 [0] 1296/39.44.99 • Asia/Pacific 603/735-2417