

DESCRIPTION

The 1N5518BUR thru 1N5546BUR series of 0.5 watt glass surface mount Zener voltage regulators provides a selection from 3.3 to 33 volts in standard 5% tolerances as well as tighter tolerances identified by different suffix letters on the part number. These are also available with an internal-metallurgical-bond option by adding a "-1" suffix (see separate data sheet) including JAN, JANTX, and JANTXV military qualifications. Microsemi also offers numerous other Zener products to meet higher and lower power applications.

APPEARANCE

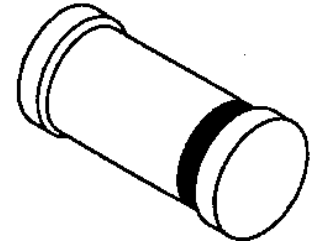

DO-213AA

IMPORTANT: For the most current data, consult MICROSEMI's website: <http://www.microsemi.com>

FEATURES

- Surface mount equivalent to JEDEC registered 1N5518 thru 1N5546 series
- Internally metallurgical bond option available by adding "-1" suffix that also includes JAN, JANTX, and JANTXV qualifications per MIL-PRF-19500/437 (see separate data sheet for same part numbers with "-1" suffix)
- DO-7 or DO-35 glass body axial-leaded Zener equivalents also available per JEDEC registration (see separate data sheets for part numbers 1N5518 thru 1N5546 DO-7 and DO-35)

APPLICATIONS / BENEFITS

- Regulates voltage over a broad operating current and temperature range
- Extensive selection from 3.3 to 33 V
- Standard voltage tolerances are plus/minus 5% with a "B" suffix, e.g. 1N5518BUR, etc.
- Tight tolerances available in plus or minus 2% or 1% with C or D suffix respectively, e.g. 1N5518CUR, 1N5518DUR, etc.
- Hermetically sealed surface mount package
- Nonsensitive to ESD per MIL-STD-750 Method 1020
- Minimal capacitance (see Figure 3)
- Inherently radiation hard as described in Microsemi MicroNote 050

MAXIMUM RATINGS

- Operating and Storage temperature: -65°C to +175°C
- Thermal Resistance: 150°C/W junction to end cap and 300°C/W junction to ambient when mounted on FR4 PC board (1 oz Cu) with recommended footprint (see last page)
- Steady-State Power: 0.5 watts at end cap temperature $T_{EC} \leq 100^\circ\text{C}$ or ambient temperature $T_A \leq 25^\circ\text{C}$ when mounted on FR4 PC board as described for thermal resistance above (see Figure 2 for derating)
- Forward voltage @200 mA: 1.1 volts (maximum)
- Solder Temperatures: 260°C for 10 s (max)

MECHANICAL AND PACKAGING

- CASE: Hermetically sealed glass DO-213AA (SOD80 or MLL34) MELF style package
- TERMINALS: End caps tin-lead plated solderable per MIL-STD-750, method 2026
- POLARITY: Cathode indicated by band where diode is to be operated with the banded end positive with respect to the opposite end for Zener regulation
- MARKING: cathode band only
- TAPE & REEL option: Standard per EIA-481-1-A with 12 mm tape, 2000 per 7 inch reel or 5000 per 13 inch reel (add "TR" suffix to part number)
- WEIGHT: 0.04 grams
- See package dimensions and recommended pad layout on last page

ELECTRICAL CHARACTERISTICS ($T_A = 25^\circ\text{C}$ unless otherwise noted. Based on DC measurements at thermal equilibrium; $V_F = 1.1$ Max @ $I_F = 200$ mA for all types.)

JEDEC TYPE NUMBER (Note 1 and Note 7)	NOMINAL ZENER VOLTAGE $V_Z @ I_{ZT}$ (Note 2) VOLTS	TEST CURRENT I_{ZT} mAdc	MAX. ZENER IMPEDANCE B-C-D SUFFIX $Z_{ZT} @ I_{ZT}$ (Note 3) OHMS	MAX. REVERSE CURRENT (Note 4)			B-C-D SUFFIX MAXIMUM DC ZENER CURRENT I_{ZM} (Note 5) mAdc	B-C-D SUFFIX MAX. NOISE DENSITY AT $I_Z = 250\mu\text{A}$ N_D $\mu\text{V}/\sqrt{\text{Hz}}$	REGULATION FACTOR ΔV_Z (Note 6) VOLTS	LOW V_Z CURRENT I_{ZL} (Note 6) mAdc
				I_R μAdc	V_R - VOLTS					
					NON & A-SUFFIX	B-C-D SUFFIX				
1N5518UR	3.3	20	26	5.0	0.90	1.0	115	0.5	0.90	2.0
1N5519UR	3.6	20	24	3.0	0.90	1.0	105	0.5	0.90	2.0
1N5520UR	3.9	20	22	1.0	0.90	1.0	98	0.5	0.85	2.0
1N5521UR	4.3	20	18	3.0	1.0	1.5	88	0.5	0.75	2.0
1N5522UR	4.7	10	22	2.0	1.5	2.0	81	0.5	0.60	1.0
1N5523UR	5.1	5.0	26	2.0	2.0	2.5	75	0.5	0.65	0.25
1N5524UR	5.6	3.0	30	2.0	3.0	3.5	68	1.0	0.30	0.25
1N5525UR	6.2	1.0	30	1.0	4.5	5.0	61	1.0	0.20	0.01
1N5526UR	6.8	1.0	30	1.0	5.5	6.2	56	1.0	0.10	0.01
1N5527UR	7.5	1.0	35	0.5	6.0	6.8	51	2.0	0.05	0.01
1N5528UR	8.2	1.0	40	0.5	6.5	7.5	46	4.0	0.05	0.01
1N5529UR	9.1	1.0	45	0.1	7.0	8.2	42	4.0	0.05	0.01
1N5530UR	10.0	1.0	60	0.05	8.0	9.1	38	4.0	0.10	0.01
1N5531UR	11.0	1.0	80	0.05	9.0	9.9	35	5.0	0.20	0.01
1N5532UR	12.0	1.0	90	0.05	9.5	10.8	32	10	0.20	0.01
1N5533UR	13.0	1.0	90	0.01	10.5	11.7	29	15	0.20	0.01
1N5534UR	14.0	1.0	100	0.01	11.5	12.6	27	20	0.20	0.01
1N5535UR	15.0	1.0	100	0.01	12.5	13.5	25	20	0.20	0.01
1N5536UR	16.0	1.0	100	0.01	13.0	14.4	24	20	0.20	0.01
1N5537UR	17.0	1.0	100	0.01	14.0	15.3	22	20	0.20	0.01
1N5538UR	18.0	1.0	100	0.01	15.0	16.2	21	20	0.20	0.01
1N5539UR	19.0	1.0	100	0.01	16.0	17.1	20	20	0.20	0.01
1N5540UR	20.0	1.0	100	0.01	17.0	18.0	19	20	0.20	0.01
1N5541UR	22.0	1.0	100	0.01	18.0	19.8	17	20	0.25	0.01
1N5542UR	24.0	1.0	100	0.01	20.0	21.6	16	20	0.30	0.01
1N5543UR	25.0	1.0	100	0.01	21.0	22.4	15	20	0.35	0.01
1N5544UR	28.0	1.0	100	0.01	23.0	25.2	14	20	0.40	0.01
1N5545UR	30.0	1.0	100	0.01	24.0	27.0	13	20	0.45	0.01
1N5546UR	33.0	1.0	100	0.01	28.0	29.7	12	20	0.50	0.01

NOTES:

- TOLERANCE AND VOLTAGE DESIGNATION –**
The JEDEC type numbers shown without a suffix letter prior to the UR are +/-20% with guaranteed limits for only V_Z , I_R , and V_F . Units with A suffix prior to the UR are +/-10% with guaranteed limits for V_Z , I_R , and V_F . Units with guaranteed limits for all six parameters are indicated by a B suffix for +/-5.0% units, C suffix for +/-2.0% and D suffix for +/-1.0% prior to the UR.
- ZENER VOLTAGE (V_Z) MEASUREMENT –**
Nominal zener voltage is measured with the device junction in thermal equilibrium with ambient temperature of 25°C .
- ZENER IMPEDANCE (Z_Z) MEASUREMENT –**
The zener impedance is derived from the 60 Hz ac voltage, which results when an ac current having an rms value equal to 10% of the dc zener current (I_{ZT}) is superimposed on I_{ZT} .
- REVERSE CURRENT (I_R) –**
Reverse currents are guaranteed and are measured at V_R as shown on the table.
- MAXIMUM REGULATOR CURRENT (I_{ZM}) –**
The maximum current shown is as shown in MIL-PRF-19500/437.
- MAXIMUM REGULATION FACTOR (ΔV_Z) –**
 ΔV_Z is the maximum difference between V_Z at I_{ZT} and V_Z at I_{ZL} measured with the device junction in thermal equilibrium.
- PART NUMBER –**
These may be ordered as either 1N5518UR thru 1N5546UR or as MLL5518 thru MLL5546 part numbers. For JAN, JANTX, or JANTXV military types, see separate data sheet for the 1N5518UR-1 thru 1N5546UR-1 part numbers.

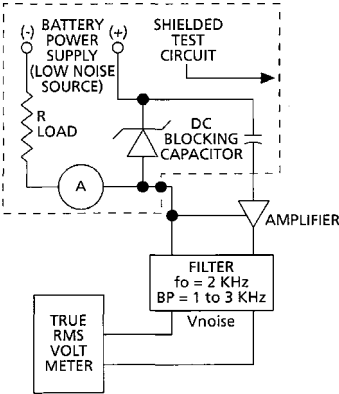

Noise density, (N_D) is specified in microvolt-rms per square-root-hertz. Actual measurement is performed using a 1 kHz to 3 kHz frequency bandpass filter at a constant Zener test current (I_{ZT}) AT 25°C ambient temperature.

FIGURE 1 Noise Density Measurement Circuit

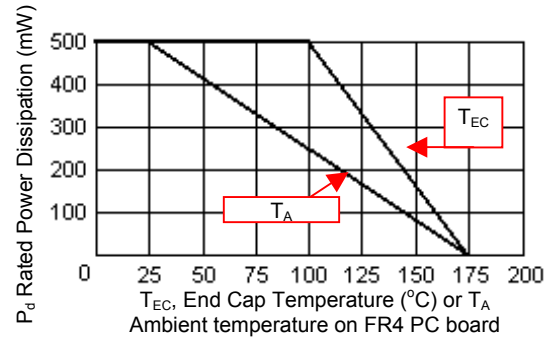

FIGURE 2 Power Derating Curve

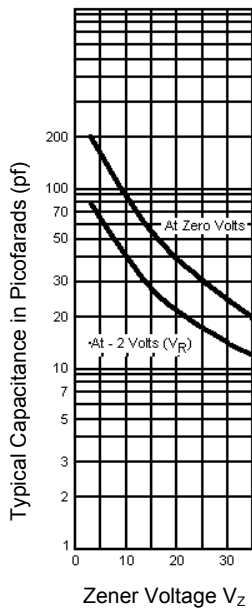

FIGURE 3 Capacitance vs. Zener Voltage (Typical)

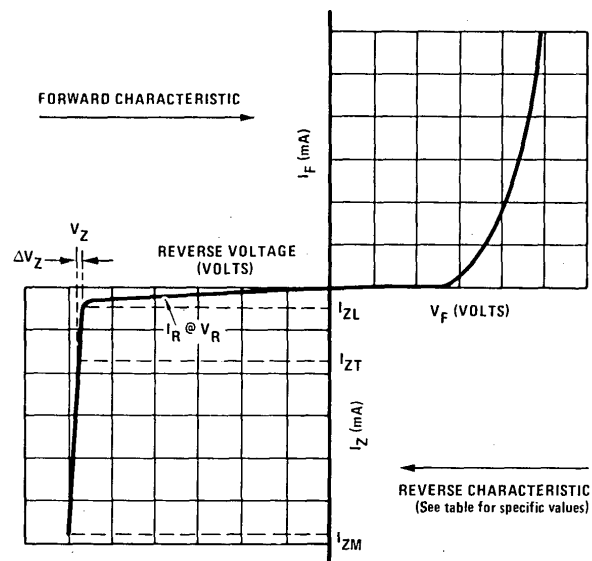
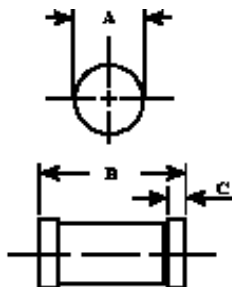
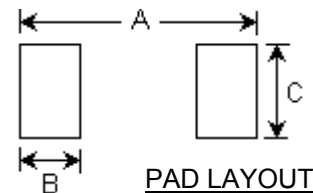

FIGURE 4 Zener Diode Characteristics and Symbol Identification

PACKAGE DIMENSIONS



DIM	INCHES		MILLIMETERS	
	MIN	MAX	MIN	MAX
A	0.063	0.067	1.60	1.70
B	0.130	0.146	3.30	3.70
C	0.016	0.022	0.41	0.55



	INCHES	mm
A	.200	5.08
B	.055	1.40
C	.080	2.03