

International IOR Rectifier

20BQ030

SCHOTTKY RECTIFIER

2 Amp

$I_{F(AV)} = 2 \text{ Amp}$
 $V_R = 30V$

Major Ratings and Characteristics

Characteristics	20BQ030	Units
$I_{F(AV)}$ Rectangular waveform	2.0	A
V_{RRM}	30	V
I_{FSM} @tp = 5 μ s sine	350	A
V_F @2.0 Apk, $T_J = 125^\circ\text{C}$	0.37	V
T_J range	-55 to 150	$^\circ\text{C}$

Description/ Features

The 20BQ030 surface-mount Schottky rectifier has been designed for applications requiring low forward drop and small foot prints on PC boards. Typical applications are in disk drives, switching power supplies, converters, free-wheeling diodes, battery charging, and reverse battery protection.

- Small foot print, surface mountable
- Very low forward voltage drop
- High frequency operation
- Guard ring for enhanced ruggedness and long term reliability

Case Styles

20BQ030

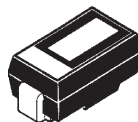

SMB



Voltage Ratings

Part number	20BQ030
V_R Max. DC Reverse Voltage (V)	30
V_{RWM} Max. Working Peak Reverse Voltage (V)	

Absolute Maximum Ratings

Parameters	20BQ	Units	Conditions
$I_{F(AV)}$ Max. Average Forward Current	2.0	A	50% duty cycle @ $T_L = 119^\circ\text{C}$, rectangular wave form.
I_{FSM} Max. Peak One Cycle Non-Repetitive Surge Current	350		5 μs Sine or 3 μs Rect. pulse
	80		10ms Sine or 6ms Rect. pulse
E_{AS} Non-Repetitive Avalanche Energy	3.0	mJ	$T_J = 25^\circ\text{C}$, $I_{AS} = 1\text{A}$, $L = 6\text{mH}$
I_{AR} Repetitive Avalanche Current	1.0	A	Current decaying linearly to zero in 1 μsec Frequency limited by T_J max. $V_a = 1.5 \times V_r$ typical

Electrical Specifications

Parameters	20BQ	Units	Conditions
V_{FM} Max. Forward Voltage Drop (1)	0.470	V	@ 2A
	0.550	V	@ 4A
V_{FM} Max. Forward Voltage Drop (1)	0.370	V	@ 2A
	0.470	V	@ 4A
I_{RM} Max. Reverse Leakage Current (1)	0.5	mA	$T_J = 25^\circ\text{C}$
	15	mA	$T_J = 125^\circ\text{C}$
C_T Max. Junction Capacitance	200	pF	$V_R = 5V_{DC}$, (test signal range 100KHz to 1Mhz) 25°C
L_S Typical Series Inductance	2.0	nH	Measured lead to lead 5mm from package body
dv/dt Max. Voltage Rate of Change (Rated V_R)	10000	V/ μs	

(1) Pulse Width < 300 μs , Duty Cycle < 2%

Thermal-Mechanical Specifications

Parameters	20BQ	Units	Conditions
T_J Max. Junction Temperature Range (*)	-55 to 150	$^\circ\text{C}$	
T_{stg} Max. Storage Temperature Range	-55 to 150	$^\circ\text{C}$	
R_{thJL} Max. Thermal Resistance Junction to Lead (**)	25	$^\circ\text{C}/\text{W}$	DC operation
R_{thJA} Max. Thermal Resistance Junction to Ambient	80	$^\circ\text{C}/\text{W}$	
wt Approximate Weight	0.10(0.003)	g (oz.)	
Case Style	SMB		Similar DO-214AA
Device Marking	IR2E		

(*) $\frac{dP_{tot}}{dT_J} < \frac{1}{R_{th(j-a)}}$ thermal runaway condition for a diode on its own heatsink

(**) Mounted 1 inch square PCB

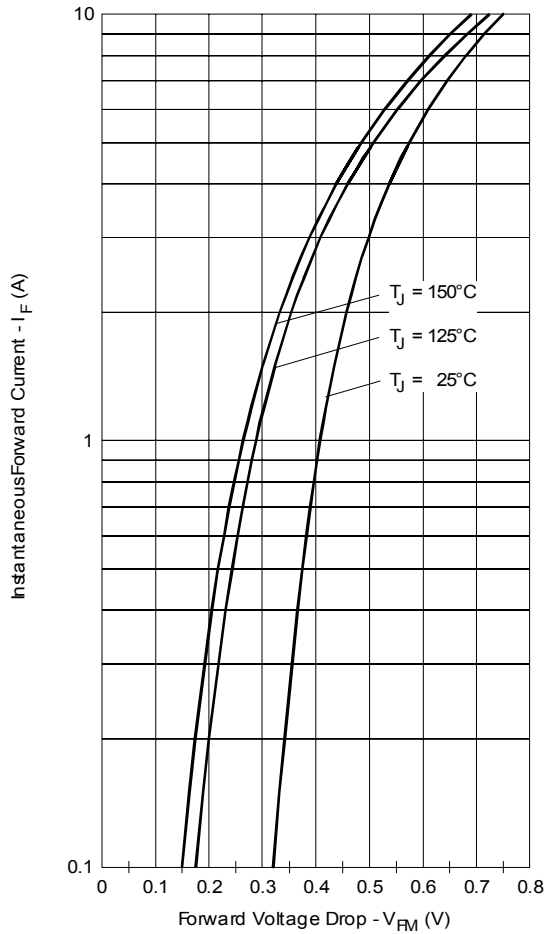

Fig. 1 - Maximum Forward Voltage Drop Characteristics

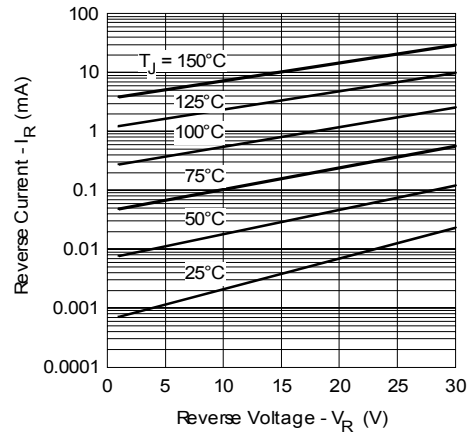

Fig. 2 - Typical Peak Reverse Current Vs. Reverse Voltage

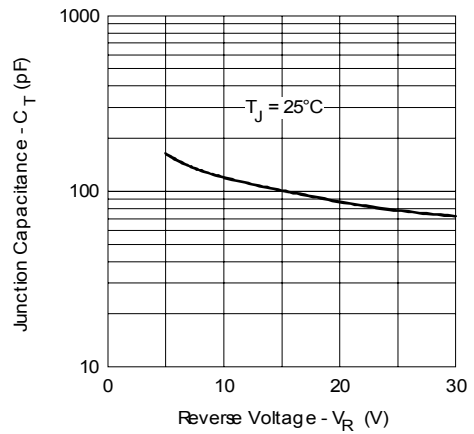

Fig. 3 - Typical Junction Capacitance Vs. Reverse Voltage

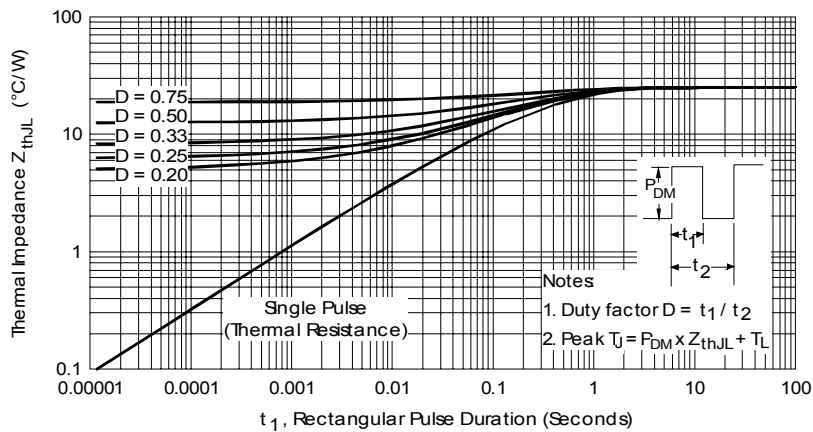

Fig. 4 - Maximum Thermal Impedance Z_{thJL} Characteristics

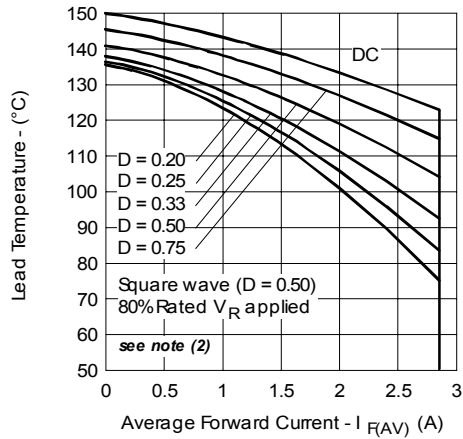

Fig. 5 - Maximum Average Forward Current Vs. Allowable Lead Temperature

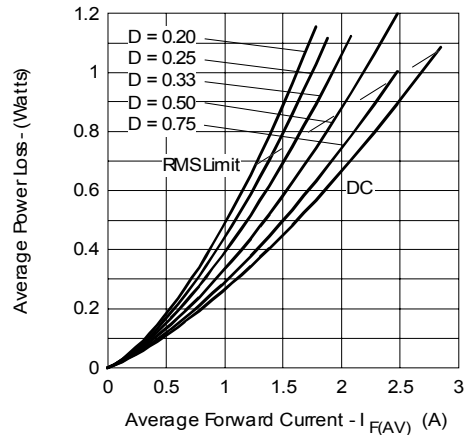

Fig. 6 - Maximum Average Forward Dissipation Vs. Average Forward Current

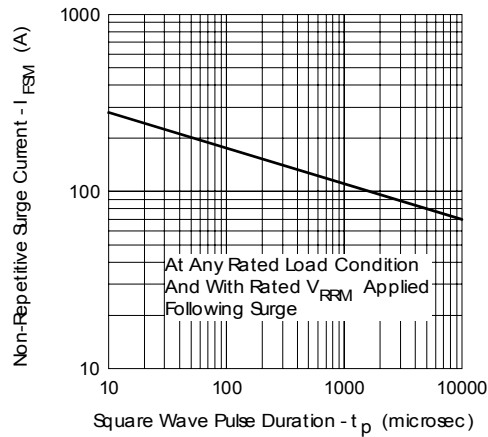
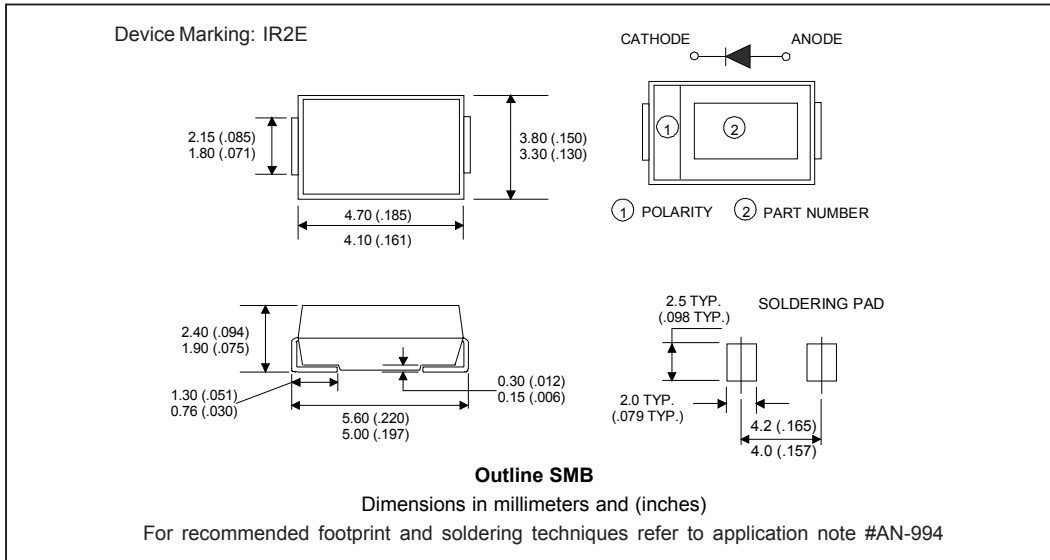

Fig. 7 - Maximum Peak Surge Forward Current Vs. Pulse Duration

- (2) Formula used: $T_L = T_J - (Pd + Pd_{REV}) \times R_{thJL}$;
 $Pd = \text{Forward Power Loss} = I_{F(AV)} \times V_{FM} @ (I_{F(AV)} / D)$ (see Fig. 6);
 $Pd_{REV} = \text{Inverse Power Loss} = V_{R1} \times I_R (1 - D)$; $I_R @ V_{R1} = 80\% \text{ rated } V_R$

Outline Table



Marking & Identification

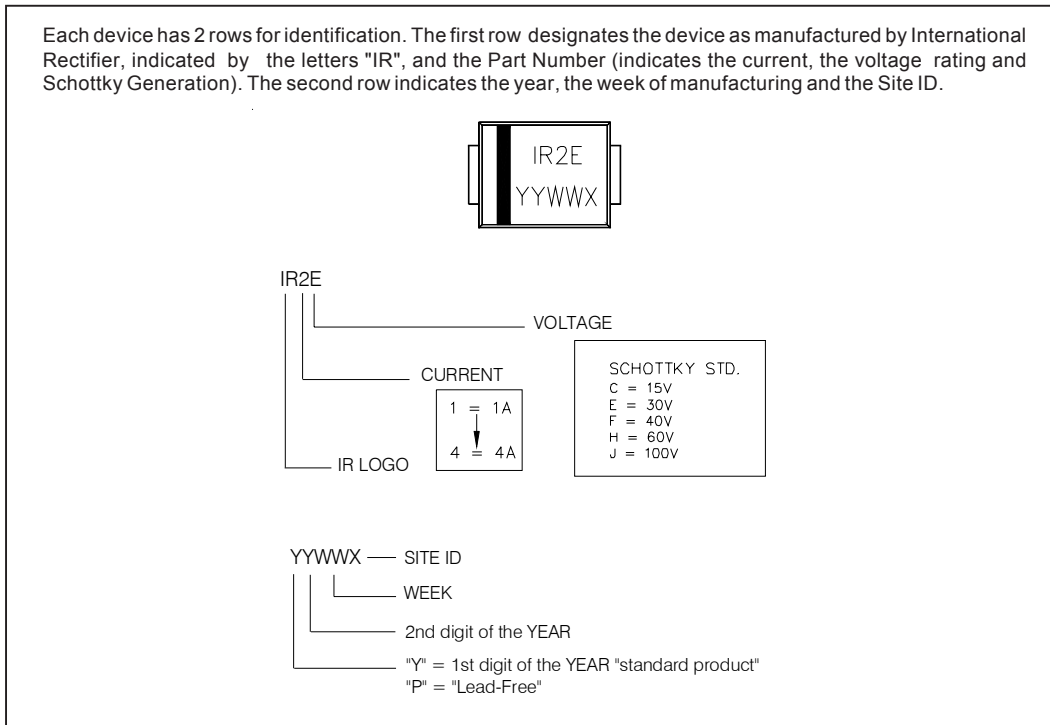

Tape & Reel Information

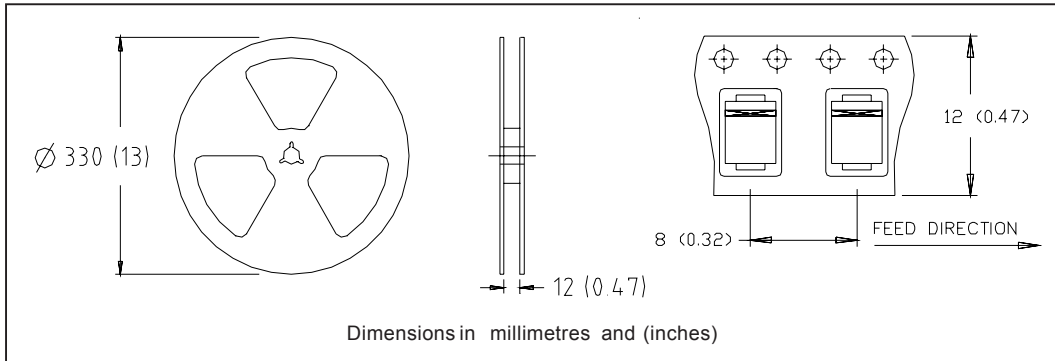

Ordering Information Table

Device Code					
20	B	Q	030	TR	-
①	②	③	④	⑤	⑥
1	- Current Rating				
2	- B = Single Lead Diode				
3	- Q = Schottky Q Series				
4	- Voltage Rating (030 = 30V)				
5	- • none = Box (1000 pieces) • TR = Tape & Reel (3000 pieces)				
6	- • none = Standard Production • PbF = Lead-Free				

Data and specifications subject to change without notice.
This product has been designed and qualified for Industrial Level.
Qualification Standards can be found on IR's Web site.