

Major Ratings and Characteristics

Characteristics	21FQ...	Units
$I_{F(AV)}$ Rectangular waveform	30	A
V_{RRM} range	35 to 45	V
I_{FSM} @ $t_p = 5 \mu s$ sine	7800	A
V_F @ 30 Apk, $T_J = 125^\circ C$	0.51	V
T_J range	-65 to 150	$^\circ C$

Description/Features

The 21FQ Schottky rectifier series has been optimized for very low forward voltage drop, with moderate leakage. The proprietary barrier technology allows for reliable operation up to 150° C junction temperature. Typical applications are in switching power supplies, converters, free-wheeling diodes, and reverse battery protection.

- 150° C T_J operation
- Very low forward voltage drop
- High frequency operation
- Guard ring for enhanced ruggedness and long term reliability
- Hermetic packaging

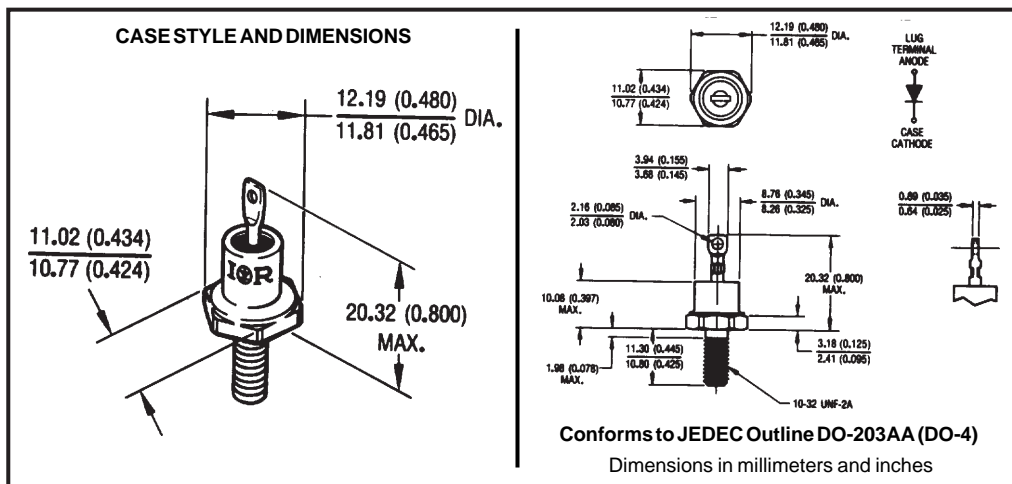

Voltage Ratings

Part number	21FQ035	21FQ040	21FQ045
V_R Max. DC Reverse Voltage (V)	35	40	45
V_{RWM} Max. Working Peak Reverse Voltage (V)			

Absolute Maximum Ratings

Parameters	21FQ	Units	Conditions
$I_{F(AV)}$ Max. Average Forward Current * See Fig. 5	30	A	50% duty cycle @ $T_C = 107^\circ\text{C}$, rectangular waveform
I_{FSM} Max. Peak One Cycle Non-Repetitive Surge Current * See Fig. 7	7800	A	Following any rated load condition and with rated V_{RWM} applied
	600		
E_{AS} Non-Repetitive Avalanche Energy	40	mJ	$T_J = 25^\circ\text{C}$, $I_{AS} = 6$ Amps, $L = 2.2$ mH
I_{AR} Repetitive Avalanche Current	6	A	Current decaying linearly to zero in 1 μsec Frequency limited by T_J max. $V_A = 1.5 \times V_R$ typical

Electrical Specifications

Parameters	21FQ	Units	Conditions
V_{FM} Max. Forward Voltage Drop (1) * See Fig. 1	0.57	V	@ 30A $T_J = 25^\circ\text{C}$
	0.69	V	@ 60A
	0.51	V	@ 30A $T_J = 125^\circ\text{C}$
	0.65	V	@ 60A
I_{RM} Max. Reverse Leakage Current (1) * See Fig. 2	4	mA	$T_J = 25^\circ\text{C}$
	150	mA	$T_J = 125^\circ\text{C}$ $V_R = \text{rated } V_R$
C_T Max. Junction Capacitance	1850	pF	$V_R = 5V_{DC}$, (test signal range 100Khz to 1Mhz) 25°C
L_S Typical Series Inductance	6.5	nH	Measured from top of terminal to mounting plane
dv/dt Max. Voltage Rate of Change (Rated V_R)	10,000	V/ μs	

(1) Pulse Width < 300 μs , Duty Cycle < 2%

Thermal-Mechanical Specifications

Parameters	21FQ	Units	Conditions
T_J Max. Junction Temperature Range	-65 to 150	$^\circ\text{C}$	
T_{stg} Max. Storage Temperature Range	-65 to 150	$^\circ\text{C}$	
R_{thJC} Max. Thermal Resistance Junction to Case	1.25	$^\circ\text{C/W}$	DC operation * See Fig. 4
R_{thCS} Typical Thermal Resistance, Case to Heatsink	0.50	$^\circ\text{C/W}$	Mounting surface, smooth and greased
wt Approximate Weight	5.8(0.2)	g(oz.)	
T Mounting Torque	Min.	14(12)	Non-lubricated threads
	Max.	23(20)	
Case Style	DO-203AA(DO-4)	JEDEC	

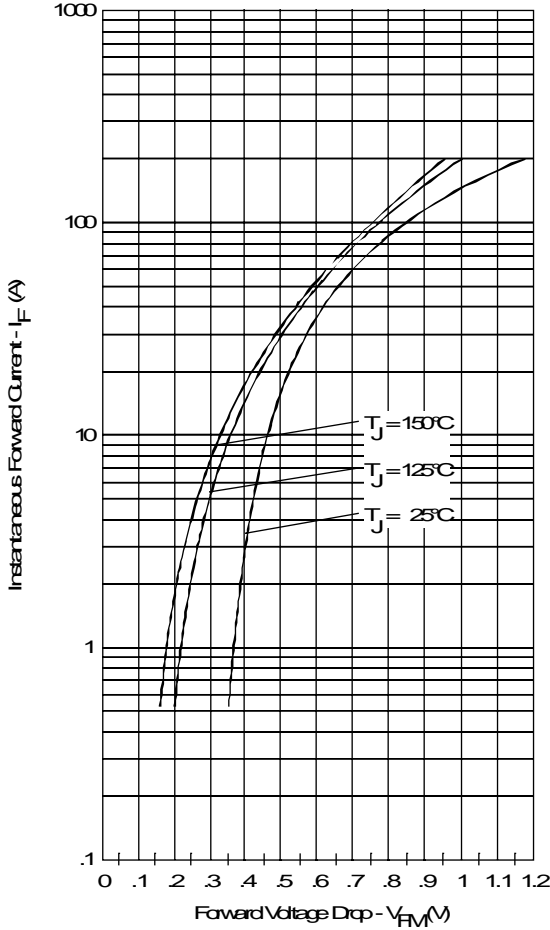

Fig. 1 - Maximum Forward Voltage Drop Characteristics

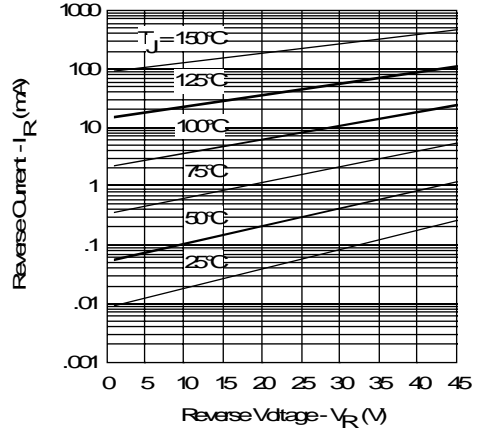

Fig. 2 - Typical Values of Reverse Current Vs. Reverse Voltage

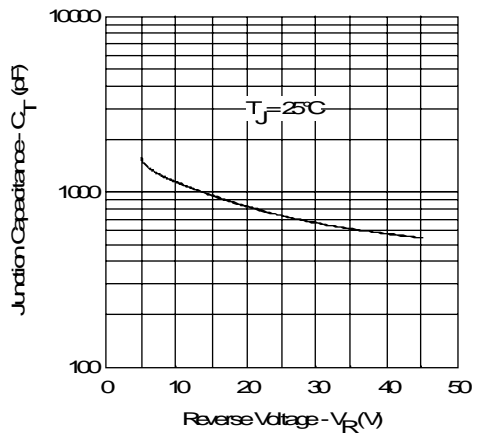

Fig. 3 - Typical Junction Capacitance Vs. Reverse Voltage

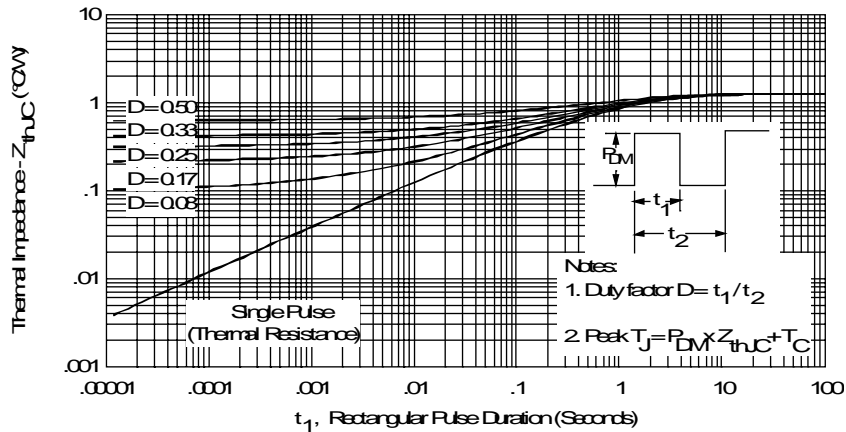

Fig. 4 - Maximum Thermal Impedance Z_{thJC} Characteristics

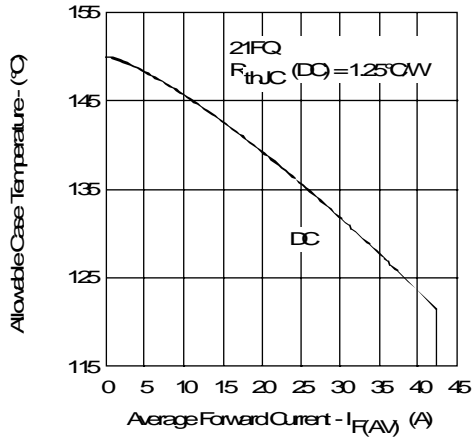

Fig. 5 - Maximum Allowable Case Temperature Vs. Average Forward Current

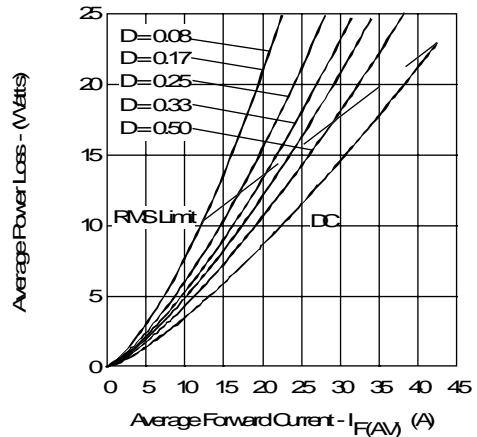

Fig. 6 - Forward Power Loss Characteristics

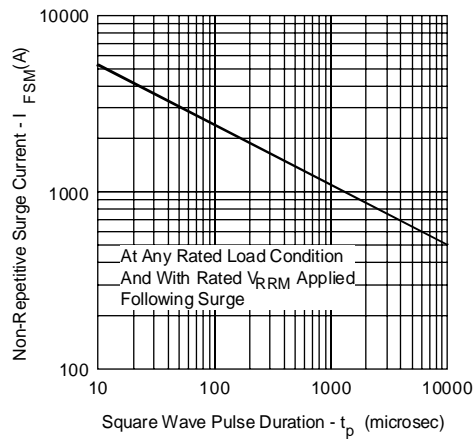

Fig. 7 - Maximum Non-Repetitive Surge Current

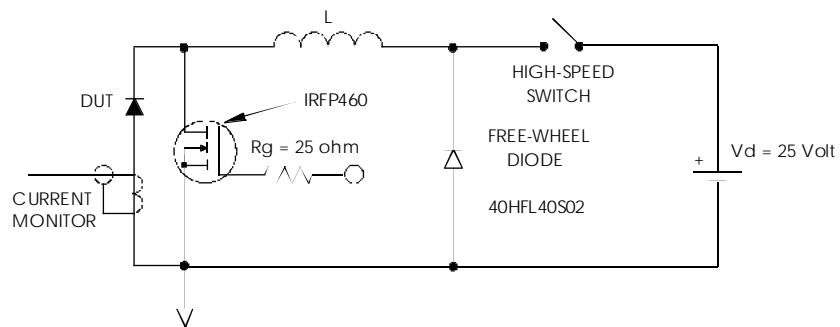

Fig. 8 - Unclamped Inductive Test Circuit