



Features

- Lead free versions available
- RoHS compliant (lead free version)*
- ESD protection
- Protects four lines
- Low capacitance 15 pF

Applications

- Cell phones
- PDAs and notebooks
- MP3 players

2DAD-C5R - Integrated Passive & Active Device using CSP

General Information

The 2DAD-C5R device, manufactured using Thin Film on Silicon technology, provides ESD protection for the external ports of portable electronic devices such as cell phones, modems and PDAs.

The ESD protection provided by the component enables a data port to withstand a minimum ± 8 KV Contact / ± 15 KV Air Discharge per the ESD test method specified in IEC 61000-4-2. The device measures 1.00 mm x 1.33 mm and is available in a 5 bump CSP package intended to be mounted directly onto an FR4 printed circuit board. The CSP device meets typical thermal cycle and bend test specifications without the use of an underfill material.

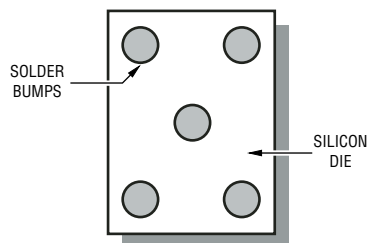

Electrical & Thermal Characteristics

Electrical Characteristics ($T_A = 25^\circ\text{C}$ unless otherwise noted)	Symbol	Minimum	Nominal	Maximum	Unit
Capacitance @ 2.5 V 1 MHz	C	12	15	18	pF
Rated Standoff Voltage	V_{WM}		5.0		V
Breakdown Voltage @ 1 mA	V_{BR}	6.0			V
Forward Voltage @ 10 mA	V_F		0.8		V
Leakage Current @ 3.3 V	I_R			0.1	μA
ESD Protection: IEC 61000-4-2					
Contact Discharge		± 8			kV
Air Discharge		± 15			kV
Thermal Characteristics ($T_A = 25^\circ\text{C}$ unless otherwise noted)					
DC Power Rating	P			200	mW
Operating Temperature Range	T_J	-40	25	+85	$^\circ\text{C}$
Storage Temperature Range	T_{STG}	-55	25	+150	$^\circ\text{C}$

*RoHS Directive 2002/95/EC Jan 27 2003 including Annex

Specifications are subject to change without notice.

Customers should verify actual device performance in their specific applications.

2DAD-C5R - Integrated Passive & Active Device using CSP

BOURNS®

Mechanical Characteristics

This is a silicon-based device and is packaged using chip scale packaging technology. Solder bumps, formed on the silicon die, provide the interconnect medium from die to PCB. The bumps are arranged on the die in a regular grid formation. The grid pitch is 0.5 mm and the dimensions for the packaged device are shown below.

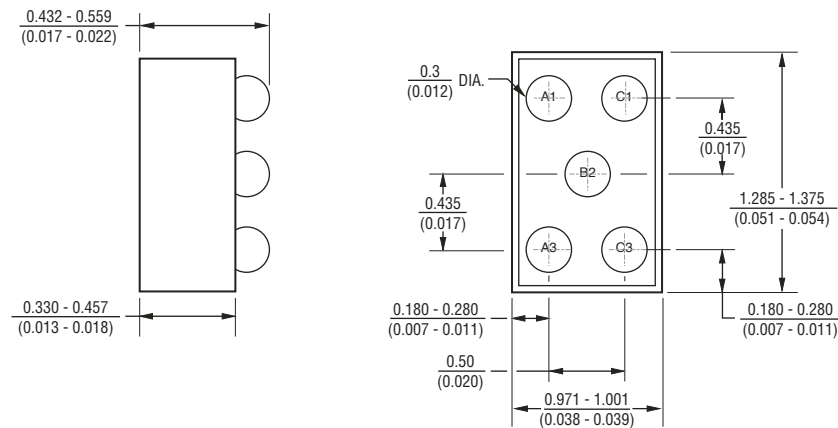

DIMENSIONS = $\frac{\text{MILLIMETERS}}{\text{(INCHES)}}$

Reliability Data

Reliability data is gathered on an ongoing basis for Bourns® Integrated Passive and Active Devices.

“Package level” testing of the integrity of the solder joint is carried out on an independent Daisy-Chain test device. A 25-Pin Daisy Chain component is available from Bourns for this purpose (part number 2TAD-C25R). This is a 5 x 5 array featuring 0.5 mm pitch solder bumps. The Distance to Neutral Point (DNP) on that component is larger than that of the 2DAD-C5R and is thus deemed suitable for Thermal Cycle testing.

“Silicon level” reliability performance is based on similarity to other integrated passive CSP devices from Bourns.

Overshoot and Clamping Voltage Response

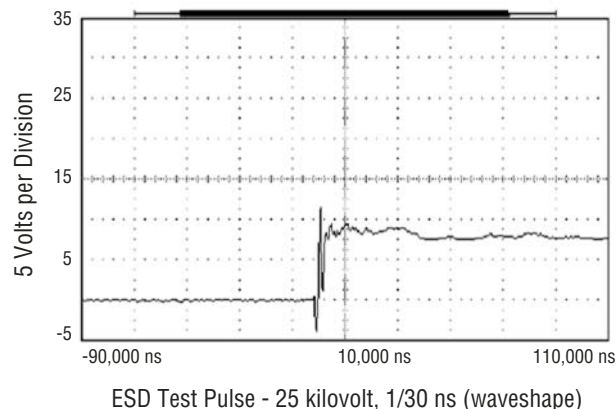

2DAD-C5R - Integrated Passive & Active Device using CSP

BOURNS®

Block Diagram

The CSP device block diagram below includes the pin names and basic electrical connections associated with each channel.

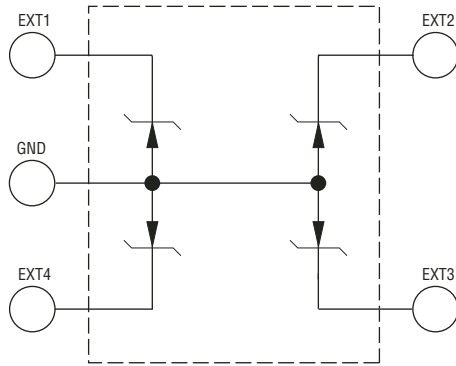

PCB Design and SMT Processing

Please consult the "Bourns Design Guide Using CSP" for notes on PCB design and SMT Processing.

How to Order

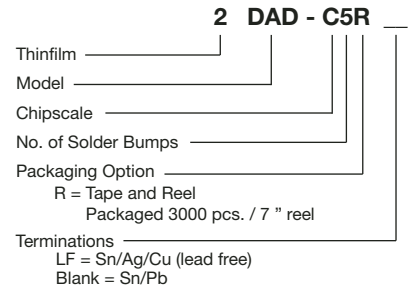

2DAD-C5R - Integrated Passive & Active Device using CSP

BOURNS®

Device Pin Out

The pin-out for the device is shown below with the bumps facing up.

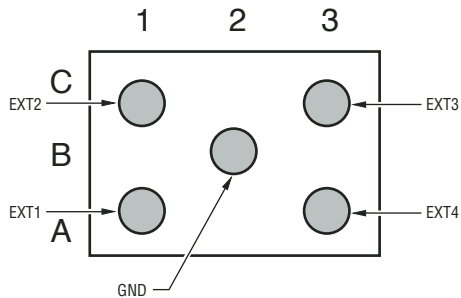

Pin Out	Function	Pin Out	Function
A1	EXT1	A3	EXT4
C1	EXT2	C3	EXT3
B2	GND		

Packaging

The surface mount product is packaged in an 8 mm x 4 mm Tape and Reel format per EIA-481 standard.

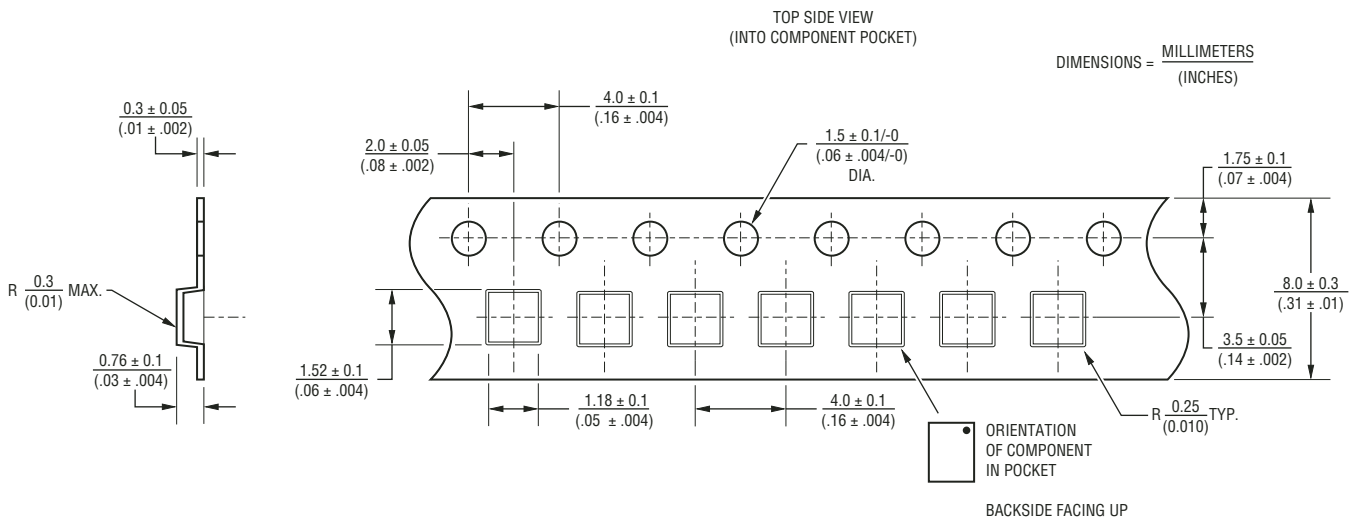

Reliable Electronic Solutions

Asia-Pacific: TEL +886- (0)2 25624117 • FAX +886- (0)2 25624116

Europe: TEL +41-41 768 5555 • FAX +41-41 768 5510

The Americas: TEL +1-951 781-5492 • FAX +1-951 781-5700

www.bourns.com