

Power Transistors

DEVICE POLARITY		I_C Max A	V_{CE0} Max V	h_{FE} Min/Max @ I_C A		$V_{CE(sat)}$ Max @ I_C V A		t_T Min MHz	$P_D(Max)$ $T_C=25^\circ C$ W	PACK- AGE
2N3054	NPN	4.0	55	25/150	0.5	1.0	0.5	-	25	TO-66
2N3055	NPN	15	60	20/70	4.0	1.1	4.0	-	117	TO-3
2N3055SD	NPN	15	60	20/70	4.0	1.1	4.0	0.8	115	TO-3
2N3439	NPN	1.0	350	40/160	0.02	0.5	0.05	15	10	TO-39
2N3440	NPN	1.0	250	40/160	0.02	0.5	0.05	15	10	TO-39
2N3713	NPN	10	60	25/75	1.0	1.0	5.0	4.0	150	TO-3
2N3714	NPN	10	80	25/75	1.0	1.0	5.0	4.0	150	TO-3
2N3715	NPN	10	60	50/150	1.0	0.8	5.0	4.0	150	TO-3
2N3716	NPN	10	80	50/150	1.0	0.8	5.0	2.5	150	TO-3
2N3740	PNP	1.0	60	30/100	0.25	0.6	1.0	4.0	25	TO-66
2N3741	PNP	1.0	80	30/100	0.25	0.6	1.0	4.0	25	TO-66
2N3766	NPN	3.0	60	40/160	0.5	1.0	0.5	10	20	TO-66
2N3767	NPN	3.0	80	40/160	0.5	1.0	0.5	10	20	TO-66
2N3771	NPN	30	40	15/60	15	2.0	15	0.2	150	TO-3
2N3772	NPN	20	60	15/60	10	1.4	10	0.2	150	TO-3
2N3789	PNP	10	60	25/90	1.0	1.0	5.0	4.0	150	TO-3
2N3790	PNP	10	80	25/90	1.0	1.0	5.0	4.0	150	TO-3
2N3791	PNP	10	60	50/180	1.0	1.0	5.0	4.0	150	TO-3
2N3792	PNP	10	80	50/180	1.0	1.0	5.0	4.0	150	TO-3
2N4231	NPN	4.0	40	25/100	1.5	0.7	1.5	4.0	35	TO-66
2N4232	NPN	4.0	60	25/100	1.5	0.7	1.5	4.0	35	TO-66
2N4233	NPN	4.0	80	25/100	1.5	0.7	1.5	4.0	35	TO-66
2N4234	PNP	3.0	40	30/150	0.25	0.6	1.0	3.0	6.0	TO-39
2N4235	PNP	3.0	60	30/150	0.25	0.6	1.0	3.0	6.0	TO-39
2N4236	PNP	3.0	80	30/150	0.25	0.6	1.0	3.0	6.0	TO-39
2N4237	NPN	4.0	40	30/150	0.25	0.6	1.0	1.0	6.0	TO-39
2N4238	NPN	4.0	60	30/150	0.25	0.6	1.0	1.0	6.0	TO-39
2N4239	NPN	4.0	80	30/150	0.25	0.6	1.0	1.0	6.0	TO-39
2N4398	PNP	30	40	15/60	15	1.0	15	4.0	200	TO-3
2N4399	PNP	30	60	15/60	15	1.0	15	4.0	200	TO-3
2N4895	NPN	5.0	60	40/120	2.0	1.0	5.0	50	7.0	TO-39
2N4896	NPN	5.0	60	100/300	2.0	1.0	5.0	80	7.0	TO-39
2N4897	NPN	5.0	80	40/120	2.0	1.0	5.0	50	7.0	TO-39
2N4898	PNP	1.0	40	20/100	0.5	0.6	1.0	3.0	25	TO-66
2N4899	PNP	1.0	60	20/100	0.5	0.6	1.0	3.0	25	TO-66
2N4900	PNP	1.0	80	20/100	0.5	0.6	1.0	3.0	25	TO-66
2N4901	PNP	5.0	40	20/80	1.0	1.5	5.0	4.0	87.5	TO-3
2N4902	PNP	5.0	60	20/80	1.0	1.5	5.0	4.0	87.5	TO-3
2N4903	PNP	5.0	80	20/80	1.0	1.5	5.0	4.0	87.5	TO-3
2N4904	PNP	5.0	40	25/100	2.5	1.5	5.0	4.0	87.5	TO-3
2N4905	PNP	5.0	60	25/100	2.5	1.5	5.0	4.0	87.5	TO-3
2N4906	PNP	5.0	80	25/100	2.5	1.5	5.0	4.0	87.5	TO-3
2N4907	PNP	10	40	20/80	4.0	0.75	4.0	4.0	150	TO-3
2N4908	PNP	10	60	20/80	4.0	0.75	4.0	4.0	150	TO-3
2N4909	PNP	10	80	20/80	4.0	2.0	10	4.0	150	TO-3
2N4910	NPN	1.0	40	20/100	0.5	0.6	1.0	4.0	25	TO-66
2N4911	NPN	1.0	60	20/100	0.5	0.6	1.0	4.0	25	TO-66
2N4912	NPN	1.0	80	20/100	0.5	0.6	1.0	4.0	25	TO-66
2N4913	NPN	5.0	40	25/100	2.5	1.5	5.0	4.0	87.5	TO-3
2N4914	NPN	5.0	60	25/100	2.5	1.5	5.0	4.0	87.5	TO-3

Power Transistors

DEVICE POLARITY		I_C Max A	V_{CEO} Max V	h_{FE} Min/Max @ I_C A		$V_{CE(sat)}$ Max @ I_C V A		f_T Min MHz	$P_D(Max)$ $T_C=25^\circ C$ W	PACK- AGE
2N4915	NPN	5.0	80	25/100	2.5	1.5	5.0	4.0	87.5	TO-3
2N5038	NPN	20	90	20/100	12	1.0	12	60	140	TO-3
2N5039	NPN	20	75	20/100	10	1.0	10	60	140	TO-3
2N5058	NPN	0.15	300	35/150	.03	1.0	.03	30	1.0	TO-39
2N5059	NPN	0.15	250	30/150	.03	1.0	.03	30	1.0	TO-39
2N5067	NPN	5.0	40	20/80	1.0	0.4	1.0	4.0	87.5	TO-3
2N5068	NPN	5.0	60	20/80	1.0	0.4	1.0	4.0	87.5	TO-3
2N5069	NPN	5.0	80	20/80	1.0	0.4	1.0	4.0	87.5	TO-3
2N5301	NPN	30	40	15/60	15	2.0	20	2.0	200	TO-3
2N5302	NPN	30	60	15/60	15	2.0	20	2.0	200	TO-3
2N5303	NPN	20	80	15/60	10	2.0	20	2.0	200	TO-3
2N5320	NPN	2.0	75	30/130	0.5	0.5	0.5	50	10	TO-39
2N5321	NPN	2.0	50	40/250	0.5	0.8	0.5	50	10	TO-39
2N5322	PNP	2.0	75	30/130	0.5	0.5	0.5	50	10	TO-39
2N5323	PNP	2.0	50	40/250	0.5	0.8	0.5	50	10	TO-39
2N5334	NPN	3.0	60	30/150	1.0	0.7	2.0	40	6.0	TO-39
2N5335	NPN	3.0	80	30/150	1.0	0.7	2.0	40	6.0	TO-39
2N5336	NPN	5.0	80	30/120	2.0	0.7	2.0	30	6.0	TO-39
2N5337	NPN	5.0	80	60/240	2.0	0.7	2.0	30	6.0	TO-39
2N5338	NPN	5.0	100	30/120	2.0	0.7	2.0	30	6.0	TO-39
2N5339	NPN	5.0	100	60/240	2.0	0.7	2.0	30	6.0	TO-39
2N5415	PNP	1.0	200	30/150	0.05	2.5	0.05	15	10	TO-39
2N5416	PNP	1.0	300	30/120	0.05	2.0	0.05	15	10	TO-39
2N5629	NPN	16	100	25/100	8.0	1.0	10	0.5	200	TO-3
2N5630	NPN	16	120	20/80	8.0	1.0	10	0.5	200	TO-3
2N5631	NPN	16	140	15/60	8.0	1.0	10	0.5	200	TO-3
2N5679	PNP	1.0	100	40/150	0.25	1.0	0.5	30	10	TO-39
2N5680	PNP	1.0	120	40/150	0.25	1.0	0.5	30	10	TO-39
2N5681	NPN	1.0	100	40/150	0.25	1.0	0.5	30	10	TO-39
2N5682	NPN	1.0	120	40/150	0.25	1.0	0.5	30	10	TO-39
2N5683	PNP	50	60	15/60	25	1.0	25	2.0	300	TO-3
2N5684	PNP	50	80	15/60	25	1.0	25	2.0	300	TO-3
2N5685	NPN	50	60	15/60	25	1.0	25	2.0	300	TO-3
2N5686	NPN	50	80	15/60	25	1.0	25	2.0	300	TO-3
2N5838	NPN	3.0	250	8/40	3.0	1.0	3.0	5.0	100	TO-3
2N5839	NPN	3.0	275	10/50	2.0	1.5	2.0	5.0	100	TO-3
2N5840	NPN	3.0	350	10/50	2.0	1.5	2.0	5.0	100	TO-3
2N5871	PNP	7.0	60	20/100	2.5	1.0	4.0	4.0	115	TO-3
2N5872	PNP	7.0	80	20/100	2.5	1.0	4.0	4.0	115	TO-3
2N5873	NPN	7.0	60	20/100	2.5	1.0	4.0	4.0	115	TO-3
2N5874	NPN	7.0	80	20/100	2.5	1.0	4.0	4.0	115	TO-3
2N5875	PNP	8.0	60	20/100	4.0	1.0	5.0	4.0	150	TO-3
2N5876	PNP	8.0	80	20/100	4.0	1.0	5.0	4.0	150	TO-3
2N5877	NPN	8.0	60	20/100	4.0	1.0	5.0	4.0	150	TO-3
2N5878	NPN	8.0	80	20/100	4.0	1.0	5.0	4.0	150	TO-3
2N5879	PNP	12	60	20/100	6.0	1.0	7.0	4.0	160	TO-3
2N5880	PNP	12	80	20/100	6.0	1.0	7.0	4.0	160	TO-3
2N5881	NPN	12	60	20/100	6.0	1.0	7.0	4.0	160	TO-3
2N5882	NPN	12	80	20/100	6.0	1.0	7.0	4.0	160	TO-3
2N5883	PNP	20	60	20/100	10	1.0	15	4.0	200	TO-3

Power Transistors

DEVICE POLARITY		I _C Max A	V _{CEO} Max V	h _{FE}		V _{CE(sat)} Max @ I _C		f _T Min MHz	P _{D(Max)} T _C =25°C W	PACK- AGE
				Min/Max @ I _C	A	V	A			
2N5884	PNP	20	80	20/100	10	1.0	15	4.0	200	TO-3
2N5885	NPN	20	60	20/100	10	1.0	15	4.0	200	TO-3
2N5886	NPN	20	80	20/100	10	1.0	15	4.0	200	TO-3
2N6029	PNP	16	100	25/100	8.0	2.0	16	1.0	200	TO-3
2N6030	PNP	16	120	20/80	8.0	2.0	16	1.0	200	TO-3
2N6031	PNP	16	140	15/60	8.0	2.0	46	1.0	200	TO-3
2N6050	PNP	12	60	750/18K	6.0	2.0	6.0	4.0	150	TO-3
2N6051	PNP	12	80	750/18K	6.0	2.0	6.0	4.0	150	TO-3
2N6052	PNP	12	100	750/18K	6.0	2.0	6.0	4.0	150	TO-3
2N6053	PNP	8.0	60	750/18K	4.0	2.0	4.0	4.0	100	TO-3
2N6054	PNP	8.0	80	750/18K	4.0	2.0	4.0	4.0	100	TO-3
2N6055	NPN	8.0	60	750/18K	4.0	2.0	4.0	4.0	100	TO-3
2N6056	NPN	8.0	80	750/18K	4.0	2.0	4.0	4.0	100	TO-3
2N6057	NPN	12	60	750/18K	6.0	2.0	6.0	4.0	150	TO-3
2N6058	NPN	12	80	750/18K	6.0	2.0	6.0	4.0	150	TO-3
2N6059	NPN	12	100	750/18K	6.0	2.0	6.0	4.0	150	TO-3
2N6121	NPN	4.0	45	25/100	1.5	0.6	1.5	2.5	40	TO-220
2N6122	NPN	4.0	60	25/100	1.5	0.6	1.5	2.5	40	TO-220
2N6123	NPN	4.0	80	20/80	1.5	0.6	1.5	2.5	40	TO-220
2N6124	PNP	4.0	45	25/100	1.5	0.6	1.5	2.5	40	TO-220
2N6125	PNP	4.0	60	25/100	1.5	0.6	1.5	2.5	40	TO-220
2N6126	PNP	4.0	80	20/80	1.5	0.6	1.5	2.5	40	TO-220
2N6129	NPN	7.0	40	20/100	2.5	1.4	7.0	2.5	50	TO-220
2N6130	NPN	7.0	60	20/100	2.5	1.4	7.0	2.5	50	TO-220
2N6131	NPN	7.0	80	20/100	2.5	2.0	7.0	2.5	50	TO-220
2N6132	PNP	7.0	40	20/100	2.5	1.4	7.0	2.5	50	TO-220
2N6133	PNP	7.0	60	20/100	2.5	1.4	7.0	2.5	50	TO-220
2N6134	PNP	7.0	80	20/100	2.5	2.0	7.0	2.5	50	TO-220
2N6249	NPN	10	200	10/50	10	1.5	10	2.5	100	TO-3
2N6250	NPN	10	275	8/50	10	1.5	10	2.5	100	TO-3
2N6251	NPN	10	350	6/50	10	1.5	10	2.5	100	TO-3
2N6282	NPN	20	60	750/18K	10	2.0	10	4.0	160	TO-3
2N6283	NPN	20	80	750/18K	10	2.0	10	4.0	160	TO-3
2N6284	NPN	20	100	750/18K	10	2.0	10	4.0	160	TO-3
2N6285	PNP	20	60	750/18K	10	2.0	10	4.0	160	TO-3
2N6286	PNP	20	80	750/18K	10	2.0	10	4.0	160	TO-3
2N6287	PNP	20	100	750/18K	10	2.0	10	4.0	160	TO-3
2N6306	NPN	8.0	250	15/75	3.0	0.8	3.0	5.0	125	TO-3
2N6307	NPN	8.0	300	15/75	3.0	1.0	3.0	5.0	125	TO-3
2N6308	NPN	8.0	350	12/60	3.0	1.5	3.0	5.0	125	TO-3
2N6383	NPN	10	40	1K/20K	5.0	2.0	5.0	20	100	TO-3
2N6384	NPN	10	60	1K/20K	5.0	2.0	5.0	20	100	TO-3
2N6385	NPN	10	80	1K/20K	5.0	2.0	5.0	20	100	TO-3
2N6386	NPN	10	40	1K/20K	3.0	2.0	3.0	20	40	TO-220
2N6387	NPN	10	60	1K/20K	3.0	2.0	3.0	20	40	TO-220
2N6388	NPN	10	80	1K/20K	3.0	2.0	3.0	20	40	TO-220
2N6473	NPN	4.0	100	15/150	1.5	1.2	1.5	10	40	TO-220
2N6474	NPN	4.0	120	15/150	1.5	1.2	1.5	10	40	TO-220
2N6475	PNP	4.0	100	15/150	1.5	1.2	1.5	10	40	TO-220
2N6476	PNP	4.0	120	15/150	1.5	1.2	1.5	10	40	TO-220
2N6486	NPN	15	40	20/150	5.0	1.3	5.0	5.0	75	TO-220

Power Transistors

DEVICE POLARITY		I_C Max A	V_{CE0} Max V	h_{FE} Min/Max @ I_C A		$V_{CE(sat)}$ Max @ I_C V A		f_T Min MHz	$P_D(\text{Max})$ $T_C=25^\circ\text{C}$ W	PACK- AGE
2N6487	NPN	15	60	20/150	5.0	1.3	5.0	5.0	75	TO-220
2N6488	NPN	15	80	20/150	5.0	1.3	5.0	5.0	75	TO-220
2N6489	PNP	15	40	20/150	5.0	1.3	5.0	5.0	75	TO-220
2N6490	PNP	15	60	20/150	5.0	1.3	5.0	5.0	75	TO-220
2N6491	PNP	15	80	20/150	5.0	1.3	5.0	5.0	75	TO-220
2N6569	NPN	12	40	15/200	4.0	1.5	4.0	1.5	100	TO-3
2N6576	NPN	15	60	2K/20K	4.0	4.0	15	10	120	TO-3
2N6577	NPN	15	90	2K/20K	4.0	4.0	15	10	120	TO-3
BC323	NPN	5.0	60	50/250	0.5	0.15	0.5		7.0	TO-39
BD220	NPN	4.0	70	30/120	0.5	1.0	0.5	0.8	36	TO-220
BD221	NPN	4.0	40	30/120	1.0	1.0	1.0	0.8	36	TO-220
BD222	NPN	4.0	60	20/80	1.5	1.0	1.5	0.8	36	TO-220
BD223	PNP	4.0	70	30/120	0.5	1.0	0.5	0.8	36	TO-220
BD224	PNP	4.0	40	30/120	1.0	1.0	1.0	0.8	36	TO-220
BD225	PNP	4.0	60	20/80	1.5	1.0	1.5	0.8	36	TO-220
BFX34	NPN	5.0	60	40/150	2.0	1.0	5.0	70	5.0	TO-39
BF257	NPN	0.1	160	25/-	0.03	1.0	0.03	75*	1.0	TO-39
BF258	NPN	0.1	250	25/-	0.03	1.0	0.03	75*	1.0	TO-39
BF259	NPN	0.1	300	25/-	0.03	1.0	0.03	75*	1.0	TO-39
BF336	NPN	0.1	180	20/-	0.03	-	-	50	1.0	TO-39
BF337	NPN	0.1	200	20/-	0.03	-	-	50	1.0	TO-39
BF338	NPN	0.1	225	20/-	0.03	-	-	50	1.0	TO-39
TIP29	NPN	3.0	40	15/75	1.0	0.7	1.0	3.0	30	TO-220
TIP29A	NPN	3.0	60	15/75	1.0	0.7	1.0	3.0	30	TO-220
TIP29B	NPN	3.0	80	15/75	1.0	0.7	1.0	3.0	30	TO-220
TIP29C	NPN	3.0	100	15/75	1.0	0.7	1.0	3.0	30	TO-220
TIP30	PNP	3.0	40	15/75	1.0	0.7	1.0	3.0	30	TO-220
TIP30A	PNP	3.0	60	15/75	1.0	0.7	1.0	3.0	30	TO-220
TIP30B	PNP	3.0	80	15/75	1.0	0.7	1.0	3.0	30	TO-220
TIP30C	PNP	3.0	100	15/75	1.0	0.7	1.0	3.0	30	TO-220
TIP31	NPN	5.0	40	10/50	3.0	1.2	3.0	3.0	40	TO-220
TIP31A	NPN	5.0	60	10/50	3.0	1.2	3.0	3.0	40	TO-220
TIP31B	NPN	5.0	80	10/50	3.0	1.2	3.0	3.0	40	TO-220
TIP31C	NPN	5.0	100	10/50	3.0	1.2	3.0	3.0	40	TO-220
TIP32	PNP	5.0	40	10/50	3.0	1.2	3.0	3.0	40	TO-220
TIP32A	PNP	5.0	60	10/50	3.0	1.2	3.0	3.0	40	TO-220
TIP32B	PNP	5.0	80	10/50	3.0	1.2	3.0	3.0	40	TO-220
TIP32C	PNP	5.0	100	10/50	3.0	1.2	3.0	3.0	40	TO-220
TIP41	NPN	6.0	40	30/-	0.3	1.5	6.0	3.0	65	TO-220
TIP41A	NPN	6.0	60	30/-	0.3	1.5	6.0	3.0	65	TO-220
TIP41B	NPN	6.0	80	30/-	0.3	1.5	6.0	3.0	65	TO-220
TIP41C	NPN	6.0	100	30/-	0.3	1.5	6.0	3.0	65	TO-220
TIP42	PNP	6.0	40	30/-	0.3	1.5	6.0	3.0	65	TO-220
TIP42A	PNP	6.0	60	30/-	0.3	1.5	6.0	3.0	65	TO-220
TIP42B	PNP	6.0	80	30/-	0.3	1.5	6.0	3.0	65	TO-220
TIP42C	PNP	6.0	100	30/-	0.3	1.5	6.0	3.0	65	TO-220
TIP61	NPN	0.5	40	40/-	0.05	0.7	0.5	3.0	15	TO-220
TIP61A	NPN	0.5	60	40/-	0.05	0.7	0.5	3.0	15	TO-220
TIP61B	NPN	0.5	80	40/-	0.05	0.7	0.5	3.0	15	TO-220

Power Transistors

DEVICE POLARITY		I_C Max A	V_{CE0} Max V	h_{FE} Min/Max @ I_C A		$V_{CE(sat)}$ Max @ I_C V A		f_T Min MHz	$P_D(Max)$ $T_C=25^\circ C$ W	PACK- AGE
TIP61C	NPN	0.5	100	40/-	0.05	0.7	0.5	3.0	15	TO-220
TIP62	PNP	0.5	40	40/-	0.05	0.7	0.5	3.0	15	TO-220
TIP62A	PNP	0.5	60	40/-	0.05	0.7	0.5	3.0	15	TO-220
TIP62B	PNP	0.5	80	40/-	0.05	0.7	0.5	3.0	15	TO-220
TIP62C	PNP	0.5	100	40/-	0.05	0.7	0.5	3.0	15	TO-220
TIP110	NPN	2.0	60	1K/-	1.0	2.5	2.0	-	50	TO-220
TIP111	NPN	2.0	80	1K/-	1.0	2.5	2.0	-	50	TO-220
TIP112	NPN	2.0	100	1K/-	1.0	2.5	2.0	-	50	TO-220
TIP115	PNP	2.0	60	1K/-	1.0	2.5	2.0	-	50	TO-220
TIP116	PNP	2.0	80	1K/-	1.0	2.5	2.0	-	50	TO-220
TIP117	PNP	2.0	100	1K/-	1.0	2.5	2.0	-	50	TO-220
TIP120	NPN	5.0	60	1K/-	0.5	2.0	3.0	-	65	TO-220
TIP121	NPN	5.0	80	1K/-	0.5	2.0	3.0	-	65	TO-220
TIP122	NPN	5.0	100	1K/-	0.5	2.0	3.0	-	65	TO-220
TIP125	PNP	5.0	60	1K/-	0.5	2.0	3.0	-	65	TO-220
TIP126	PNP	5.0	80	1K/-	0.5	2.0	3.0	-	65	TO-220
TIP127	PNP	5.0	100	1K/-	0.5	2.0	3.0	-	65	TO-220

Power Transistors

TYPE NO.	POLARITY	CASE	MAXIMUM RATINGS			HFE				VCE(SAT)		f _T min (MHz)	COMPLEMENTARY TYPE
			P _d (W)	I _C (A)	V _{CEO} (V)	min	max	I _C (A)	V _{CE} (V)	max (V)	I _C (A)		
BD 239	N	TO-220B	30	2	45	15	—	1	4	0.7	1	3	BD 240
BD 239A	N	TO-220B	30	2	60	15	—	1	4	0.7	1	3	BD 240A
BD 239B	N	TO-220B	30	2	80	15	—	1	4	0.7	1	3	BD 240B
BD 240	P	TO-220B	30	2	45	15	—	1	4	0.7	1	3	BD 239
BD 240A	P	TO-220B	30	2	60	15	—	1	4	0.7	1	3	BD 239A
BD 240B	P	TO-220B	30	2	80	15	—	1	4	0.7	1	3	BD 239B
BD 241	N	TO-220B	40	3	45	25	—	1	4	1.2	3	3	BD 242
BD 241A	N	TO-220B	40	3	60	25	—	1	4	1.2	3	3	BD 242A
BD 241B	N	TO-220B	40	3	80	25	—	1	4	1.2	3	3	BD 242B
BD 242	P	TO-220B	40	3	45	25	—	1	4	1.2	3	3	BD 241
BD 242A	P	TO-220B	40	3	60	25	—	1	4	1.2	3	3	BD 241A
BD 242B	P	TO-220B	40	3	80	25	—	1	4	1.2	3	3	BD 241B
BD 301	N	TO-220B	55	8	45	30	—	3	2	1	3	3	—
BD 303	N	TO-220B	55	8	60	30	—	3	2	1	3	3	—
BD 415	N	TO-220B	2	1	60	80	300	0.05	1	0.5	0.25	75	BD 416
BD 416	P	TO-220B	2	1	60	80	300	0.05	1	0.5	0.25	75	BD 415
BD 417	N	TO-220B	2	1	80	80	300	0.05	1	0.5	0.25	75	BD 418
BD 418	P	TO-220B	2	1	80	80	300	0.05	1	0.5	0.25	75	BD 417
BD 533	N	TO-220B	50	4	45	25	—	2	2	0.8	2	3	BD 534
BD 535	N	TO-220B	50	4	60	25	—	2	2	0.8	2	3	BD 536
BD 537	N	TO-220B	50	4	80	15	—	2	2	0.8	2	3	BD 538
BD 633	N	TO-220B	30	2	45	25	—	1	2	0.6	1	3	BD 634
BD 634	P	TO-220B	30	2	45	25	—	1	2	0.6	1	3	BD 633
BD 635	N	TO-220B	30	2	60	25	—	1	2	0.6	1	3	BD 636
BD 636	P	TO-220B	30	2	60	25	—	1	2	0.6	1	3	BD 635
BD 637	N	TO-220B	30	2	80	25	—	1	2	0.6	1	3	BD 638
BD 638	P	TO-220B	30	2	80	25	—	1	2	0.6	1	3	BD 637
CX 701	N	TO-220B	25	2	120	30	120	0.5	5	1	1	—	—
CX 701A	N	TO-220B	25	2	150	30	120	0.5	5	1	1	—	—
CX 702	N	TO-220B	40	5	80	15	70	4	5	2	4	—	—
CX 702A	N	TO-220B	40	5	100	15	70	4	5	2	4	—	—
CX 704	N	TO-220B	30	4	50	40	240#	1	2	1	2	3	CX 754
CX 754	P	TO-220B	30	4	50	40	240#	1	2	1	2	3	CX 704
D 44C1	N	TO-220B	30	4	30	10	—	1	1	0.5	1	30+	D 45C1
D 44C2	N	TO-220B	30	4	30	20	—	1	1	0.5	1	30+	D 45C2
D 44C3	N	TO-220B	30	4	30	20	—	2	1	0.5	1	30+	D 45C3
D 44C4	N	TO-220B	30	4	45	10	—	1	1	0.5	1	30+	D 45C4
D 44C5	N	TO-220B	30	4	45	20	—	1	1	0.5	1	30+	D 45C5
D 44C6	N	TO-220B	30	4	45	20	—	2	1	0.5	1	30+	D 45C6
D 44C7	N	TO-220B	30	4	60	10	—	1	1	0.5	1	30+	D 45C7
D 44C8	N	TO-220B	30	4	60	20	—	1	1	0.5	1	30+	D 45C8
D 44C9	N	TO-220B	30	4	60	20	—	2	1	0.5	1	30+	D 45C9
D 44C10	N	TO-220B	30	4	80	10	—	1	1	0.5	1	30+	D 45C10
D 44C11	N	TO-220B	30	4	80	20	—	1	1	0.5	1	30+	D 45C11
D 44C12	N	TO-220B	30	4	80	20	—	2	1	0.5	1	30+	D 45C12
D 45C1	P	TO-220B	30	4	30	10	—	1	1	0.5	1	30+	D 44C1
D 45C2	P	TO-220B	30	4	30	20	—	1	1	0.5	1	30+	D 44C2
D 45C3	P	TO-220B	30	4	30	20	—	2	1	0.5	1	30+	D 44C3
D 45C4	P	TO-220B	30	4	45	10	—	1	1	0.5	1	30+	D 44C4
D 45C5	P	TO-220B	30	4	45	20	—	1	1	0.5	1	30+	D 44C5
D 45C6	P	TO-220B	30	4	45	20	—	2	1	0.5	1	30+	D 44C6
D 45C7	P	TO-220B	30	4	60	10	—	1	1	0.5	1	30+	D 44C7
D 45C8	P	TO-220B	30	4	60	20	—	1	1	0.5	1	30+	D 44C8

#HFE groupings available + Typical value

Power Transistors

TYPE NO.	POLARITY	CASE	MAXIMUM RATINGS			HFE				VCE(SAT)		f _T min (MHz)	COMPLE- MENTARY TYPE
			P _d (W)	I _C (A)	V _{CEO} (V)	min	max	I _C (A)	V _{CE} (V)	max (V)	I _C (A)		
2SB 513A	P	TO-220A	25	3	80	30	160#	1	3	1	2	—	2SD 366A
2SB 514	P	TO-220B	20	2	50	40	320#	1	2	1	2	8+	2SD 330
2SB 515	P	TO-220A	20	2	50	40	320#	1	2	1	2	8+	2SD 331
2SB 523	P	TO-220B	10	2	20	55	300#	0.5	4	2	1.5	—	—
2SB 526	P	TO-220B	10	0.8	80	55	300#	0.3	4	1	0.3	—	—
2SB 529	P	TO-220B	10	2	20	55	300#	0.5	4	1	1.5	—	—
2SC 789	N	TO-220B	30	4	60	40	240#	0.5	5	1.5	3	3	2SA 489
2SC 790	N	TO-220B	25	3	40	40	240#	0.5	2	1.4	2	3	2SA 490
2SC 1060	N	TO-220A	25	3	50	35	320#	0.1	4	1	2	3	2SA 670
2SC 1061	N	TO-220B	25	3	50	35	320#	0.1	4	1	2	3	2SA 671
2SC 1173	N	TO-220B	10	3	30	40	400#	0.5	2	0.8	2	100+	2SA 473
2SC 1626	N	TO-220B	10	0.75	80	70	240#	0.15	2	0.5	0.5	50	2SA 816
2SD 234	N	TO-220B	25	3	50	40	240#	0.5	5	1.2	3	1.5+	2SB 434
2SD 235	N	TO-220B	25	3	40	40	240#	0.5	5	1	1	1.5+	2SB 435
2SD 288	N	TO-220B	20	3	60	40	200#	0.5	5	2	2	35+	—
2SD 289	N	TO-220A	20	3	60	40	200#	0.5	5	2	2	35+	—
2SD 313	N	TO-220B	30	3	60	40	320#	1	2	1	2	8+	2SB 507
2SD 314	N	TO-220A	30	3	60	40	320#	1	2	1	2	8+	2SB 508
2SD 330	N	TO-220B	20	2	50	40	320#	1	2	1	2	8+	2SB 514
2SD 331	N	TO-220A	20	2	50	40	320#	1	2	1	2	8+	2SB 515
2SD 356	N	TO-220B	10	0.8	80	55	300#	0.3	4	1	0.3	—	—
2SD 359	N	TO-220B	10	2	20	55	300#	0.5	4	1	1.5	—	—
2SD 360	N	TO-220B	10	2	20	55	300#	0.5	4	2	1.5	—	—
2SD 365	N	TO-220B	25	3	60	30	160#	1	3	1	2	3	2SB 512
2SD 365A	N	TO-220B	25	3	80	30	160#	1	3	1	2	3	2SB 512A
2SD 366	N	TO-220A	25	3	60	30	160#	1	3	1	2	—	2SB 513
2SD 366A	N	TO-220A	25	3	80	30	160#	1	3	1	2	—	2SB 513A
2SD 526	N	TO-220B	30	4	80	40	240#	0.5	5	1.5	3	3	2SB 596
2SD 570	N	TO-220B	30	4	70	40	240#	0.5	5	1.5	3	3	2SB 604

HFE groupings available + Typical value

Packaging Information

PACKAGING INFORMATION

1. CATHODE
2. GATE
3. ANODE

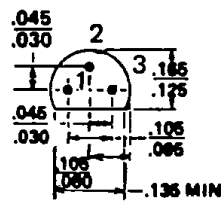
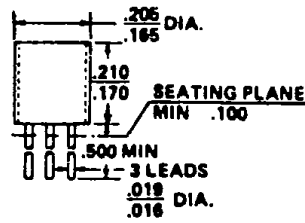

TO-18 (PLASTIC)

SCR

1. CATHODE
2. GATE
3. ANODE

TRIAC

1. MT 1
2. GATE
3. MT 2

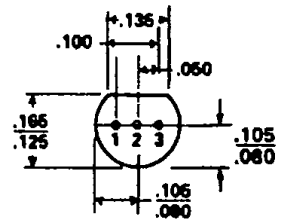
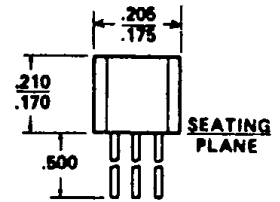

TO-92

1. CATHODE
2. GATE
3. ANODE

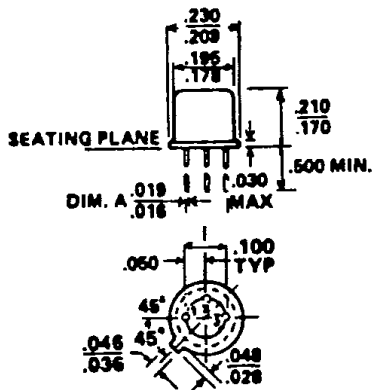

TO-18

SCR

1. CATHODE
2. GATE
3. ANODE

TRIAC

1. MT 1
2. GATE
3. MT 2

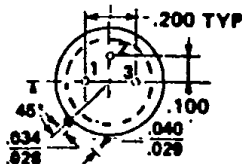
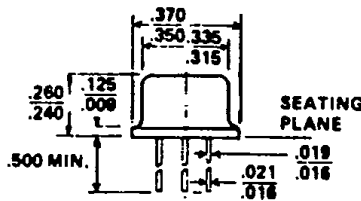

TO-39

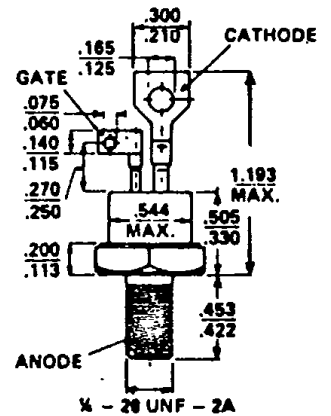

TO-48D