

Sensitive Gate Triacs

Silicon Bidirectional Thyristors

... designed primarily for full-wave ac control applications, such as light dimmers, motor controls, heating controls and power supplies; or wherever full-wave silicon gate controlled solid-state devices are needed. Triac type thyristors switch from a blocking to a conducting state for either polarity of applied anode voltage with positive or negative gate triggering.

- Sensitive Gate Triggering Uniquely Compatible for Direct Coupling to TTL, HTL, CMOS and Operational Amplifier Integrated Circuit Logic Functions
- Gate Triggering 4 Mode — 2N6071A,B, 2N6073A,B, 2N6075A,B
- Blocking Voltages to 600 Volts
- All Diffused and Glass Passivated Junctions for Greater Parameter Uniformity and Stability
- Small, Rugged, Thermopad Construction for Low Thermal Resistance, High Heat Dissipation and Durability

2N6071A,B*
2N6073A,B*
2N6075A,B*

*Motorola preferred devices

TRIACs
4 AMPERES RMS
200 thru 600 VOLTS

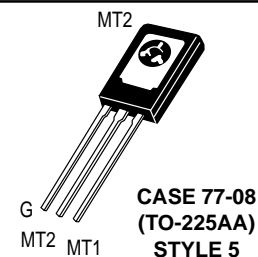
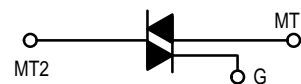

MAXIMUM RATINGS ($T_J = 25^\circ\text{C}$ unless otherwise noted.)

Rating	Symbol	Value	Unit
*Peak Repetitive Off-State Voltage ⁽¹⁾ (Gate Open, $T_J = 25$ to 110°C)	V_{DRM}	200 400 600	Volts
*On-State Current RMS ($T_C = 85^\circ\text{C}$)	$I_{\text{T(RMS)}}$	4	Amps
*Peak Surge Current (One Full cycle, 60 Hz, $T_J = -40$ to $+110^\circ\text{C}$)	I_{TSM}	30	Amps
Circuit Fusing Considerations ($t = 8.3$ ms)	I^2t	3.7	A^2s
*Peak Gate Power	P_{GM}	10	Watts
*Average Gate Power	$P_{\text{G(AV)}}$	0.5	Watt
*Peak Gate Voltage	V_{GM}	5	Volts

*Indicates JEDEC Registered Data.

1. V_{DRM} for all types can be applied on a continuous basis. Blocking voltages shall not be tested with a constant current source such that the voltage ratings of the devices are exceeded.

Preferred devices are Motorola recommended choices for future use and best overall value.

REV 1

2N6071A,B 2N6073A,B 2N6075A,B**MAXIMUM RATINGS**

Rating	Symbol	Value	Unit
*Operating Junction Temperature Range	T_J	-40 to +110	°C
*Storage Temperature Range	T_{stg}	-40 to +150	°C
Mounting Torque (6-32 Screw)(1)	—	8	in. lb.

*Indicates JEDEC Registered Data.

1. Torque rating applies with use of compression washer (B52200F006). Mounting torque in excess of 6 in. lb. does not appreciably lower case-to-sink thermal resistance. Main terminal 2 and heatsink contact pad are common.
For soldering purposes (either terminal connection or device mounting), soldering temperatures shall not exceed +200°C, for 10 seconds. Consult factory for lead bending options.

THERMAL CHARACTERISTICS

Characteristic	Symbol	Max	Unit
*Thermal Resistance, Junction to Case	$R_{\theta JC}$	3.5	°C/W
Thermal Resistance, Junction to Ambient	$R_{\theta JA}$	75	°C/W

*Indicates JEDEC Registered Data.

ELECTRICAL CHARACTERISTICS ($T_C = 25^\circ\text{C}$ unless otherwise noted.)

Characteristic	Symbol	Min	Typ	Max	Unit
*Peak Blocking Current ($V_D = \text{Rated } V_{DRM}$, gate open, $T_J = 25^\circ\text{C}$) ($T_J = 110^\circ\text{C}$)	I_{DRM}	— —	— —	10 2	μA mA
*On-State Voltage (Either Direction) ($I_{TM} = 6 \text{ A Peak}$)	V_{TM}	—	—	2	Volts
*Peak Gate Trigger Voltage (Continuous dc) (Main Terminal Voltage = 12 Vdc, $R_L = 100 \text{ Ohms}$, $T_J = -40^\circ\text{C}$) MT2(+), G(+); MT2(-), G(-) All Types MT2(+), G(-); MT2(-), G(+) (Main Terminal Voltage = Rated V_{DRM} , $R_L = 10 \text{ k ohms}$, $T_J = 110^\circ\text{C}$) MT2(+), G(+); MT2(-), G(-) All Types MT2(+), G(-); MT2(-), G(+)	V_{GT}	— — 0.2 0.2	— 1.4 1.4 —	— 2.5 2.5 —	Volts
*Holding Current (Either Direction) (Main Terminal Voltage = 12 Vdc, Gate Open, $T_J = -40^\circ\text{C}$) (Initiating Current = 1 Adc) 2N6071A,B, 2N6073A,B, 2N6075A,B ($T_J = 25^\circ\text{C}$) 2N6071A,B, 2N6073A,B, 2N6075A,B	I_H	— —	— —	30 15	mA
Turn-On Time (Either Direction) ($I_{TM} = 14 \text{ Adc}$, $I_{GT} = 100 \text{ mAdc}$)	t_{on}	—	1.5	—	μs
Blocking Voltage Application Rate at Commutation @ V_{DRM} , $T_J = 85^\circ\text{C}$, Gate Open, $I_{TM} = 5.7 \text{ A}$, Commutating $di/dt = 2.0 \text{ A/ms}$	$dv/dt(c)$	—	5	—	$\text{V}/\mu\text{s}$

*Indicates JEDEC Registered Data.

			QUADRANT (See Definition Below)			
			I	II	III	IV
			mA	mA	mA	mA
Gate Trigger Current (Continuous dc) (Main Terminal Voltage = 12 Vdc, $R_L = 100$ ohms) Maximum Value	Type	I_{GT} @ T_J				
	2N6071A 2N6073A 2N6075A	+25°C	5	5	5	10
		-40°C	20	20	20	30
	2N6071B 2N6073B 2N6075B	+25°C	3	3	3	5
		-40°C	15	15	15	20

*Indicates JEDEC Registered Data.

**SAMPLE APPLICATION:
TTL-SENSITIVE GATE 4 AMPERE TRIAC
TRIGGERS IN MODES II AND III**

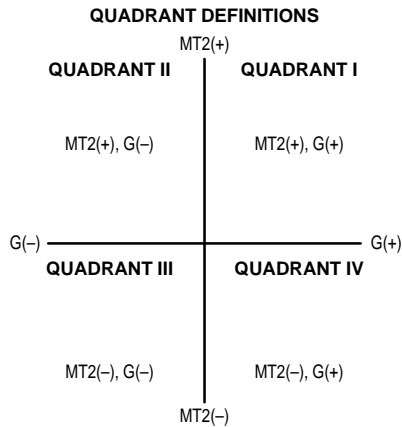
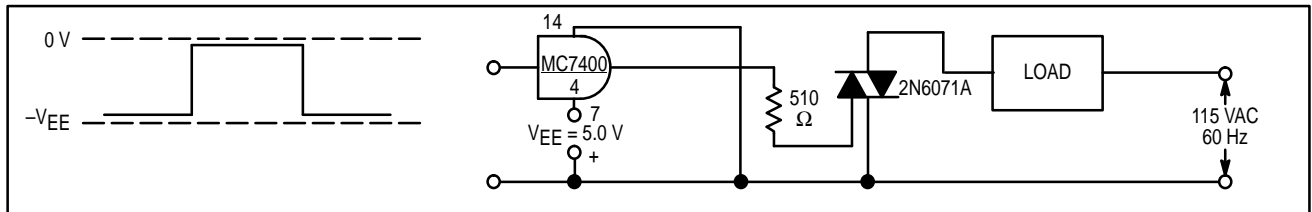

Trigger devices are recommended for gating on Triacs. They provide:

1. Consistent predictable turn-on points.
2. Simplified circuitry.
3. Fast turn-on time for cooler, more efficient and reliable operation.

SENSITIVE GATE LOGIC REFERENCE

IC Logic Functions	Firing Quadrant			
	I	II	III	IV
TTL		2N6071A Series	2N6071A Series	
HTL		2N6071A Series	2N6071A Series	
CMOS (NAND)	2N6071B Series			2N6071B Series
CMOS (Buffer)		2N6071B Series	2N6071B Series	
Operational Amplifier	2N6071A Series			2N6071A Series
Zero Voltage Switch		2N6071A Series	2N6071A Series	

2N6071A,B 2N6073A,B 2N6075A,B

FIGURE 1 – AVERAGE CURRENT DERATING

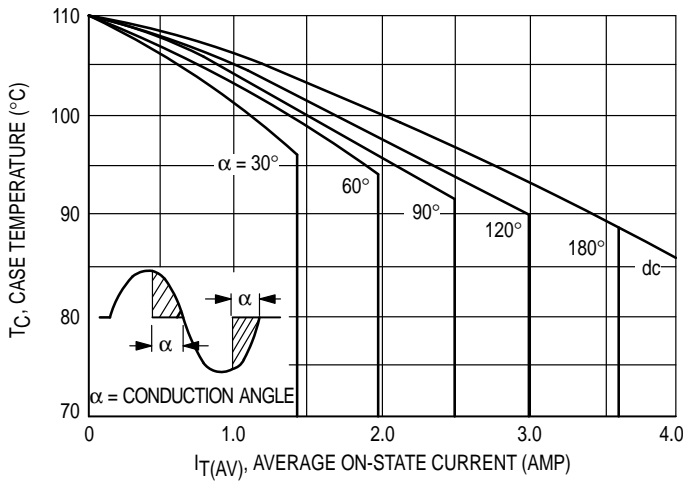

FIGURE 2 – RMS CURRENT DERATING

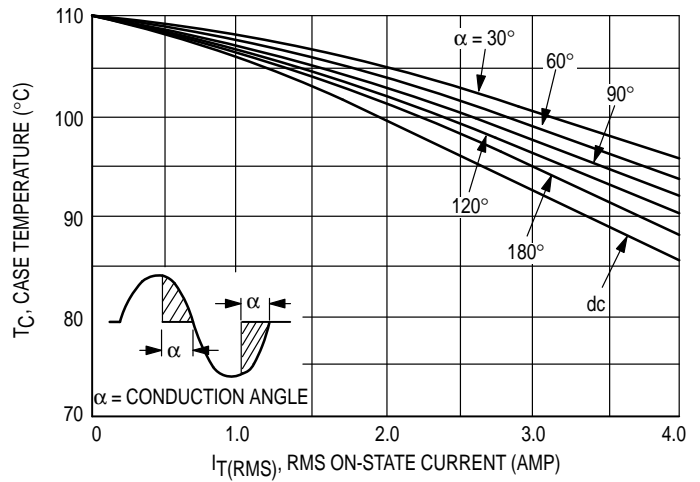

FIGURE 3 – POWER DISSIPATION

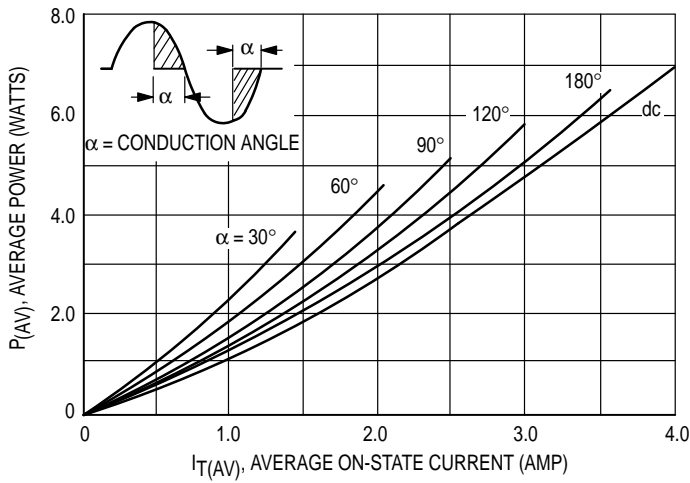

FIGURE 4 – POWER DISSIPATION

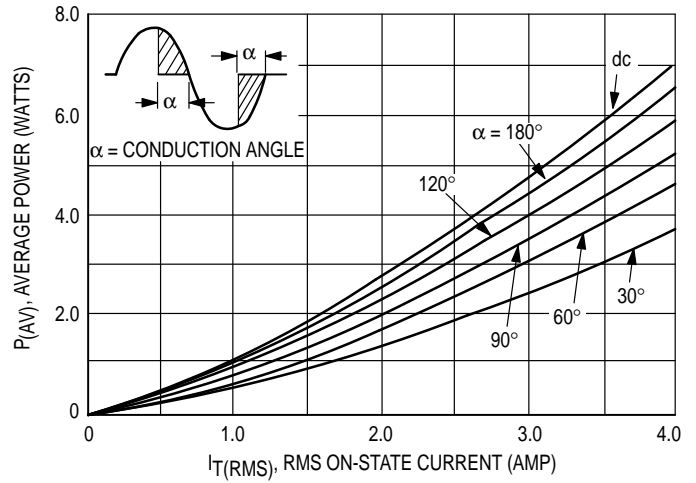

FIGURE 5 – TYPICAL GATE-TRIGGER VOLTAGE

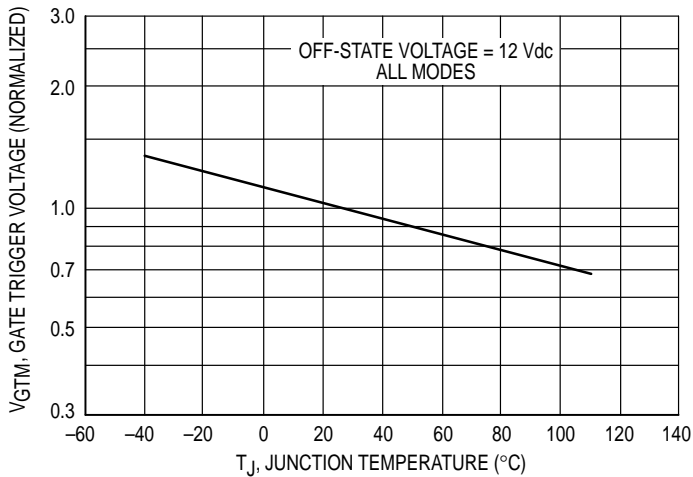

FIGURE 6 – TYPICAL GATE-TRIGGER CURRENT

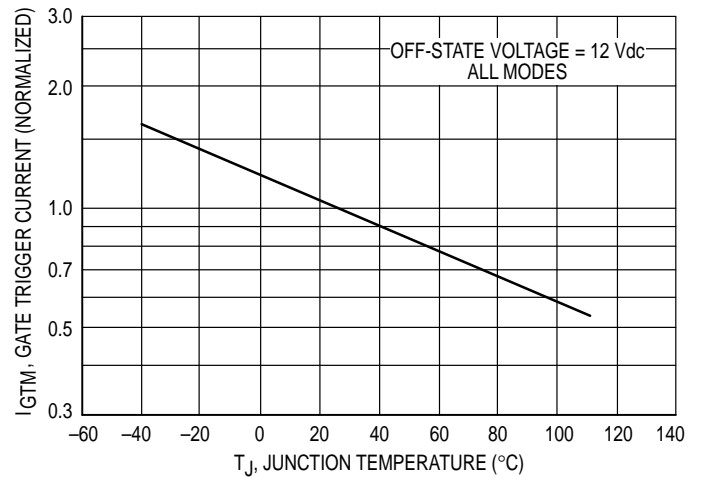

FIGURE 7 – MAXIMUM ON-STATE CHARACTERISTICS

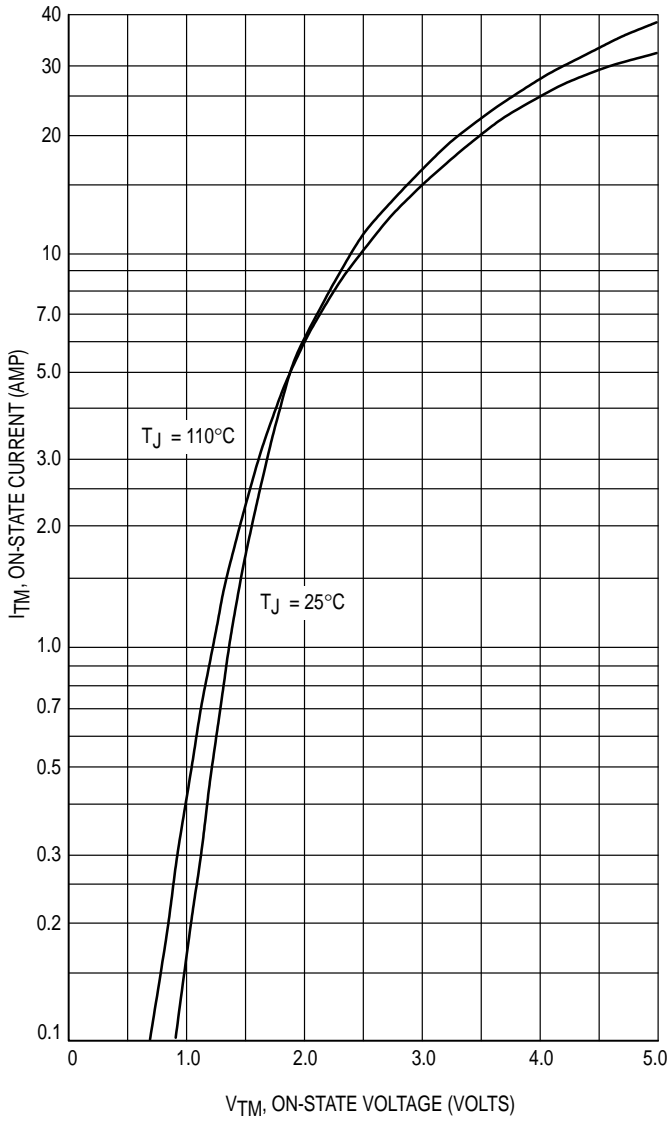

FIGURE 8 – TYPICAL HOLDING CURRENT

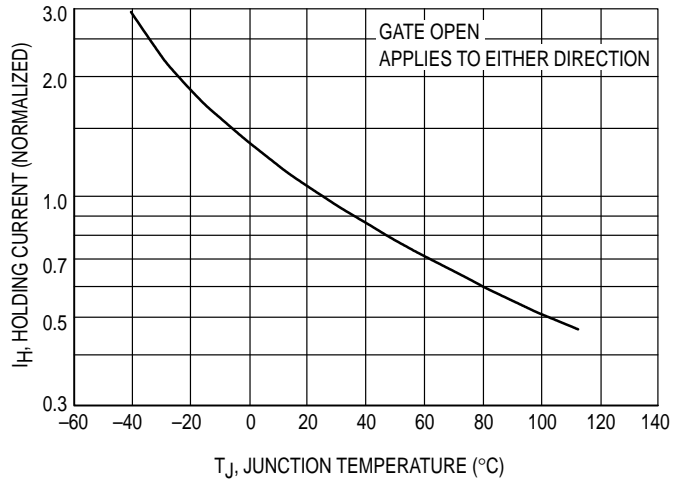

FIGURE 9 – MAXIMUM ALLOWABLE SURGE CURRENT

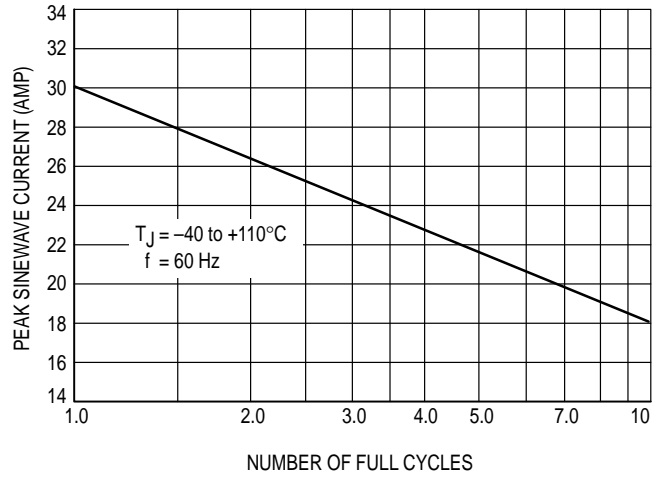
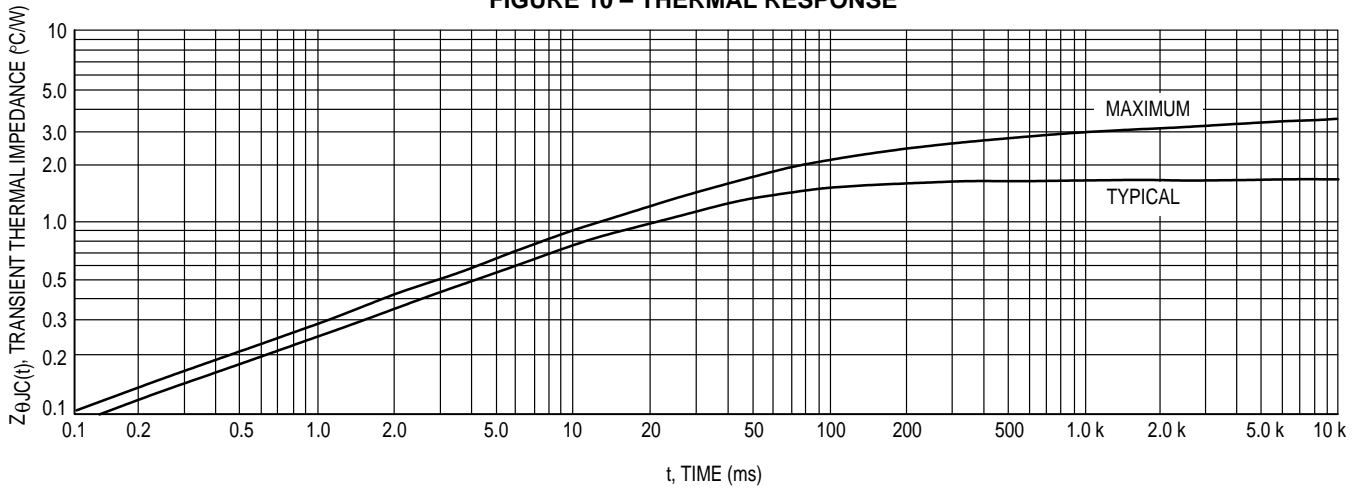
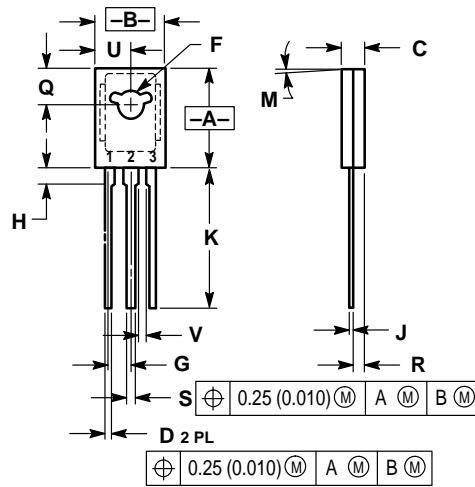

FIGURE 10 – THERMAL RESPONSE



PACKAGE DIMENSIONS



NOTES:
 1. DIMENSIONING AND TOLERANCING PER ANSI Y14.5M, 1982.
 2. CONTROLLING DIMENSION: INCH.

DIM	INCHES		MILLIMETERS	
	MIN	MAX	MIN	MAX
A	0.425	0.435	10.80	11.04
B	0.295	0.305	7.50	7.74
C	0.095	0.105	2.42	2.66
D	0.020	0.026	0.51	0.66
F	0.115	0.130	2.93	3.30
G	0.094 BSC		2.39 BSC	
H	0.050	0.095	1.27	2.41
J	0.015	0.025	0.39	0.63
K	0.575	0.655	14.61	16.63
M	5° TYP		5° TYP	
Q	0.148	0.158	3.76	4.01
R	0.045	0.065	1.15	1.65
S	0.025	0.035	0.64	0.88
U	0.145	0.155	3.69	3.93
V	0.040	—	1.02	—

STYLE 5:
 PIN 1. MT 1
 2. MT 2
 3. GATE

CASE 77-09
 (TO-225AA)
 ISSUE W

Motorola reserves the right to make changes without further notice to any products herein. Motorola makes no warranty, representation or guarantee regarding the suitability of its products for any particular purpose, nor does Motorola assume any liability arising out of the application or use of any product or circuit, and specifically disclaims any and all liability, including without limitation consequential or incidental damages. "Typical" parameters which may be provided in Motorola data sheets and/or specifications can and do vary in different applications and actual performance may vary over time. All operating parameters, including "Typicals" must be validated for each customer application by customer's technical experts. Motorola does not convey any license under its patent rights nor the rights of others. Motorola products are not designed, intended, or authorized for use as components in systems intended for surgical implant into the body, or other applications intended to support or sustain life, or for any other application in which the failure of the Motorola product could create a situation where personal injury or death may occur. Should Buyer purchase or use Motorola products for any such unintended or unauthorized application, Buyer shall indemnify and hold Motorola and its officers, employees, subsidiaries, affiliates, and distributors harmless against all claims, costs, damages, and expenses, and reasonable attorney fees arising out of, directly or indirectly, any claim of personal injury or death associated with such unintended or unauthorized use, even if such claim alleges that Motorola was negligent regarding the design or manufacture of the part. Motorola and registered trademarks of Motorola, Inc. Motorola, Inc. is an Equal Opportunity/Affirmative Action Employer.

Mfax is a trademark of Motorola, Inc.

How to reach us:

USA/EUROPE/Locations Not Listed: Motorola Literature Distribution;
 P.O. Box 5405, Denver, Colorado 80217. 1-303-675-2140 or 1-800-441-2447

JAPAN: Nippon Motorola Ltd.; SPD, Strategic Planning Office, 141,
 4-32-1 Nishi-Gotanda, Shinagawa-ku, Tokyo, Japan. 81-3-5487-8488

Customer Focus Center: 1-800-521-6274

Mfax™: RMFAX0@email.sps.mot.com – TOUCHTONE 1-602-244-6609
 Motorola Fax Back System – US & Canada ONLY 1-800-774-1848
 – http://sps.motorola.com/mfax/

ASIA/PACIFIC: Motorola Semiconductors H.K. Ltd.; 8B Tai Ping Industrial Park,
 51 Ting Kok Road, Tai Po, N.T., Hong Kong. 852-26629298

HOME PAGE: <http://motorola.com/sps/>

