

RF & MICROWAVE TRANSISTORS
130... 230MHz FM MOBILE APPLICATIONS

- FREQUENCY 175MHz
- VOLTAGE 12.5V
- POWER OUT 4 → 40W
- HIGH POWER GAIN
- HIGH EFFICIENCY
- FM CLASS C TRANSISTORS
- COMMON EMITTER

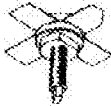

.380 4LSTUD (M135)
 epoxy sealed

ORDER CODE	BRANDING
SD1012	2N6080
SD1014-02	2N6081
SD1229-07	2N6082
SD1229-08	2N6083
SD1018	2N6084

DESCRIPTION

This line of epitaxial silicon NPN planar transistor is designed primarily for VHF mobile and marine transmitters. The device utilizes emitter ballasting resistors and improved metallization systems to achieve extreme ruggedness under severe operating conditions.

PIN CONNECTION

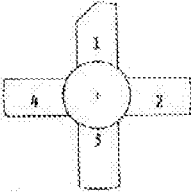

1 collector
 2 emitter
 3 base
 4 emitter

028294930-01

ABSOLUTE MAXIMUM RATINGS (T_a = 25°C)

Symbol	Parameter	Value					Unit
		2N6080	2N6081	2N6082	2N6083	2N6084	
V _{CEO}	Collector to Base Voltage	36.0	36.0	36.0	36.0	36.0	V
V _{CEO}	Collector to Emitter Voltage	18.0	18.0	18.0	18.0	18.0	V
V _{EB0}	Emitter to Base Voltage	4.0	4.0	4.0	4.0	4.0	V
I _{C(max)}	Continuous Collector Current	1.0	2.5	4.0	4.0	6.0	A
P ₀	Total Dissipation at 25°C Stud	12.0	31.0	65.0	65.0	80.0	W
T _J	Junction Temperature	+ 200	+ 200	+ 200	+ 200	+ 200	°C
T _{stg}	Storage Temperature	- 65 to + 150	- 65 to + 150	- 65 to + 150	- 65 to + 150	- 65 to + 150	°C

2N6080 → 2N6084

THERMAL DATA

		2N6080	2N6081	2N6082	2N6083	2N6084	
$R_{\theta(j-c)}$	Junction-case Thermal Resist.	15	5.6	2.6	2.8	2.2	°C/W

ELECTRICAL CHARACTERISTICS ($T_{case} = 25^{\circ}C$)

STATIC

Symbol	Test Conditions	2N6080			2N6081			2N6082			2N6083			2N6084			Unit
		Min.	Typ.	Max.	Min.	Typ.	Max.	Min.	Typ.	Max.	Min.	Typ.	Max.	Min.	Typ.	Max.	
$V_{ce(sat)}$	$I_c = 20mA, V_{be} = 0$	36			36			36			36			36			V
$V_{ce(0)}$	$I_c = 100mA, I_b = 0$	18			18			18			18			18			V
$V_{ce(10)}$	$I_c = 10mA, I_b = 0$	4			4			4			4			4			V
I_{base}	$V_{ce} = 15V, I_c = 0$			0.25			0.5			1			1			2.5	mA
I_{free}	$V_{ce} = 5V, I_c = 0.25A$	5			5			5			5			5			

DYNAMIC

Symbol	Test Conditions	2N6080			2N6081			2N6082			2N6083			2N6084			Unit
		Min.	Typ.	Max.	Min.	Typ.	Max.	Min.	Typ.	Max.	Min.	Typ.	Max.	Min.	Typ.	Max.	
P_o	$F = 175MHz, V_{ce} = 12.5V$ Class C	4			15			25			30			40			W
G_o	$F = 175MHz, V_{ce} = 12.5V$ Class C	12			6.3			6.2			6.7			4.5			dB
η_c	$F = 175MHz, V_{ce} = 12.5V$ Class C	50			60			50			50			50			%
F_r	$V_{ce} = 13.8V, I_c = 100mA, F = 100MHz$	200			200			200			200			200			MHz
C_{ob}	$V_{ce} = 15V, I_b = 0, F = 1MHz$			20			85			130			130			200	pF

APPLICATION INFORMATION (typical curves) IMPEDANCE DATA (typical)

2N6080

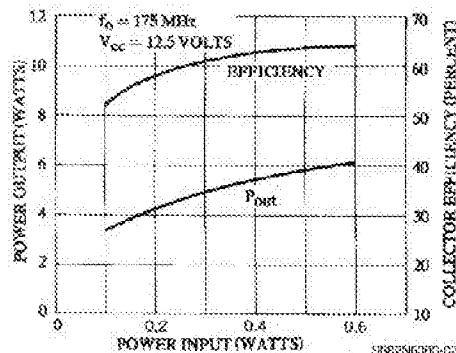

POWER OUT AND EFFICIENCY vs POWER IN

NETWORK IMPEDANCE AT TRANSISTOR TERMINALS

$f_o = 175MHz, V_{cc} = 12.5V$			
P_{in} WATTS	P_{out} WATTS	INPUT OHMS	OUTPUT OHMS
0.1	3.3	$1.5 + j1.7$	$5.8 + j1.4$
0.3	4.9	$2.2 + j1.3$	$7.6 + j0.6$
0.5	5.8	$2.0 + j0.4$	$8.4 + j0.9$

2N6081

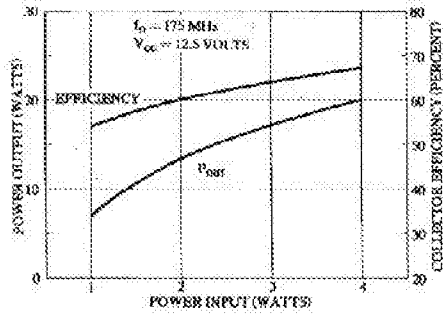

S682N6081.G1

POWER OUT AND EFFICIENCY vs POWER IN

NETWORK IMPEDANCE AT TRANSISTOR TERMINALS

$f_o = 175 \text{ MHz}, V_{cc} = 12.5 \text{ V}$

P_{in} WATTS	P_{out} WATTS	INPUT OHMS	OUTPUT OHMS
1	9.3	$0.8 - j1.0$	$4.0 + j3.0$
3	19.6	$1.0 - j1.4$	$3.3 + j1.2$
5	27.6	$1.0 - j1.0$	$2.9 + j0.6$

2N6082

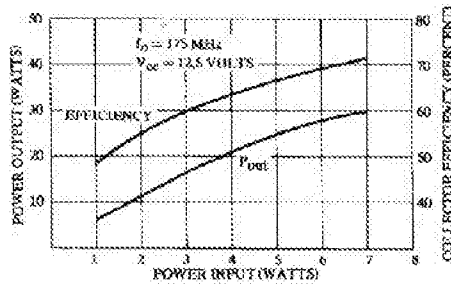

S682N6082.G1

POWER OUT AND EFFICIENCY vs POWER IN

NETWORK IMPEDANCE AT TRANSISTOR TERMINALS

$f_o = 175 \text{ MHz}, V_{cc} = 12.5 \text{ V}$

P_{in} WATTS	P_{out} WATTS	INPUT OHMS	OUTPUT OHMS
2.5	17.4	$0.8 - j1.0$	$2.4 + j1.5$
5.0	27.5	$0.9 - j0.9$	$2.1 + j0.4$
7.5	35.8	$0.9 - j1.1$	$2.2 + j0.1$

2N6080 → 2N6084

2N6084

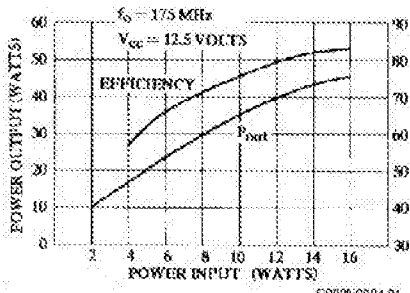

POWER OUT AND EFFICIENCY vs POWER IN

NETWORK IMPEDANCE AT TRANSISTOR TERMINALS

$f_0 = 175 \text{ MHz}, V_{cc} = 12.5 \text{ V}$

P_{in} WATTS	P_{out} WATTS	INPUT OHMS	OUTPUT OHMS
4	21.7	$0.8 - j1.1$	$2.2 - j0.3$
8	37.1	$0.8 - j1.3$	$1.7 - j0.5$
12	46.5	$0.8 - j1.6$	$1.6 - j0.3$

PACKAGE MECHANICAL DATA

.360 4LSTUD

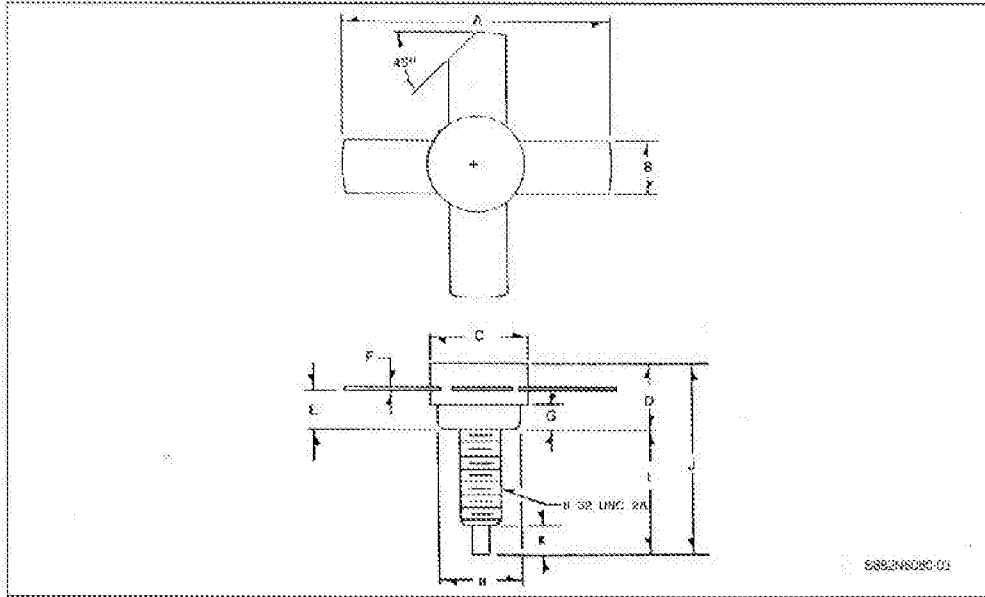

	Minimum Inches	Maximum Inches
A	.980	
B	.220	.230
C	.370	.385
D		.275
E	.155	.175
F	.004	.007

	Minimum Inches	Maximum Inches
G	.090	.100
H	.320	.330
I	.450	.490
J		.750
K	.100	.130