

Plastic Medium-Power Silicon Transistors

... designed for general-purpose amplifier and low-speed switching applications.

- High DC Current Gain —
 $h_{FE} = 2500$ (Typ) @ I_C
 $= 4.0$ Adc
- Collector-Emitter Sustaining Voltage — @ 100 mAdc
 $V_{CEO(sus)} = 60$ Vdc (Min) — 2N6387
 $= 80$ Vdc (Min) — 2N6388
- Low Collector-Emitter Saturation Voltage —
 $V_{CE(sat)} = 2.0$ Vdc (Max) @ I_C
 $= 5.0$ Adc — 2N6387, 2N6388
- Monolithic Construction with Built-In Base-Emitter Shunt Resistors
- TO-220AB Compact Package

***MAXIMUM RATINGS**

Rating	Symbol	2N6387	2N6388	Unit
Collector-Emitter Voltage	V_{CEO}	60	80	Vdc
Collector-Base Voltage	V_{CB}	60	80	Vdc
Emitter-Base Voltage	V_{EB}	5.0		Vdc
Collector Current — Continuous Peak	I_C	10 15	10 15	Adc
Base Current	I_B	250		mAdc
Total Power Dissipation @ $T_C = 25^\circ\text{C}$ Derate above 25°C	P_D	65 0.52		Watts W/ $^\circ\text{C}$
Total Power Dissipation @ $T_A = 25^\circ\text{C}$ Derate above 25°C	P_D	2.0 0.016		Watts W/ $^\circ\text{C}$
Operating and Storage Junction, Temperature Range	T_J, T_{stg}	-65 to +150		$^\circ\text{C}$

THERMAL CHARACTERISTICS

Characteristics	Symbol	Max	Unit
Thermal Resistance, Junction to Case	$R_{\theta JC}$	1.92	$^\circ\text{C/W}$
Thermal Resistance, Junction to Ambient	$R_{\theta JA}$	62.5	$^\circ\text{C/W}$

2N6387 2N6388*

*ON Semiconductor Preferred Device

**DARLINGTON
8 AND 10 AMPERE
NPN SILICON
POWER TRANSISTORS
60-80 VOLTS
65 WATTS**

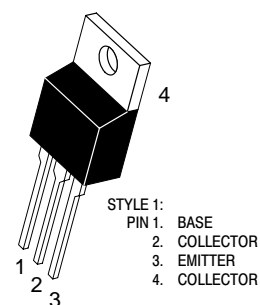

**CASE 221A-09
TO-220AB**

Preferred devices are ON Semiconductor recommended choices for future use and best overall value.

2N6387 2N6388

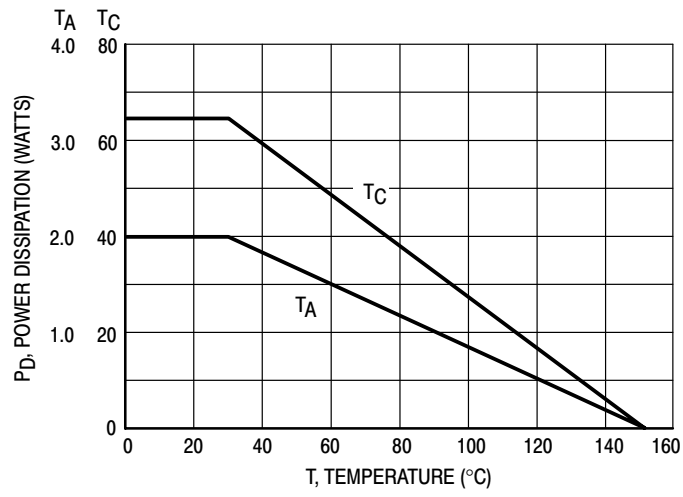

Figure 1. Power Derating

2N6387 2N6388

***ELECTRICAL CHARACTERISTICS** ($T_C = 25^\circ\text{C}$ unless otherwise noted)

Characteristic	Symbol	Min	Max	Unit	
OFF CHARACTERISTICS					
Collector–Emitter Sustaining Voltage (1) ($I_C = 200\text{ mA}$, $I_B = 0$)	2N6387 2N6388	$V_{CE(sus)}$	60 80	— —	Vdc
Collector Cutoff Current ($V_{CE} = 60\text{ Vdc}$, $I_B = 0$) ($V_{CE} = 80\text{ Vdc}$, $I_B = 0$)	2N6387 2N6388	I_{CEO}	— —	1.0 1.0	mA
Collector Cutoff Current ($V_{CE} = 60\text{ Vdc}$, $V_{EB(off)} = 1.5\text{ Vdc}$) ($V_{CE} = 80\text{ Vdc}$, $V_{EB(off)} = 1.5\text{ Vdc}$) ($V_{CE} = 60\text{ Vdc}$, $V_{EB(off)} = 1.5\text{ Vdc}$, $T_C = 125^\circ\text{C}$) ($V_{CE} = 80\text{ Vdc}$, $V_{EB(off)} = 1.5\text{ Vdc}$, $T_C = 125^\circ\text{C}$)	2N6387 2N6388 2N6387 2N6388	I_{CEX}	— — — —	300 300 3.0 3.0	μA mA
Emitter Cutoff Current ($V_{BE} = 5.0\text{ Vdc}$, $I_C = 0$)		I_{EBO}	—	5.0	mA

ON CHARACTERISTICS (1)

DC Current Gain ($I_C = 5.0\text{ A}$, $V_{CE} = 3.0\text{ Vdc}$) ($I_C = 1.0\text{ A}$, $V_{CE} = 3.0\text{ Vdc}$)	2N6387, 2N6388 2N6387, 2N6388	h_{FE}	1000 100	20,000 —	—
Collector–Emitter Saturation Voltage ($I_C = 5.0\text{ A}$, $I_B = 0.01\text{ A}$) ($I_C = 1.0\text{ A}$, $I_B = 0.1\text{ A}$)	2N6387, 2N6388 2N6387, 2N6388	$V_{CE(sat)}$	— —	2.0 3.0	Vdc
Base–Emitter On Voltage ($I_C = 5.0\text{ A}$, $V_{CE} = 3.0\text{ Vdc}$) ($I_C = 1.0\text{ A}$, $V_{CE} = 3.0\text{ Vdc}$)	2N6387, 2N6388 2N6387, 2N6388	$V_{BE(on)}$	— —	2.8 4.5	Vdc

DYNAMIC CHARACTERISTICS

Small–Signal Current Gain ($I_C = 1.0\text{ A}$, $V_{CE} = 5.0\text{ Vdc}$, $f_{test} = 1.0\text{ MHz}$)	$ h_{fe} $	20	—	—
Output Capacitance ($V_{CB} = 10\text{ Vdc}$, $I_E = 0$, $f = 1.0\text{ MHz}$)	C_{ob}	—	200	μF
Small–Signal Current Gain ($I_C = 1.0\text{ A}$, $V_{CE} = 5.0\text{ Vdc}$, $f = 1.0\text{ kHz}$)	h_{fe}	1000	—	—

*Indicates JEDEC Registered Data

(1) Pulse Test: Pulse Width $\leq 300\ \mu\text{s}$, Duty Cycle $\leq 2.0\%$.

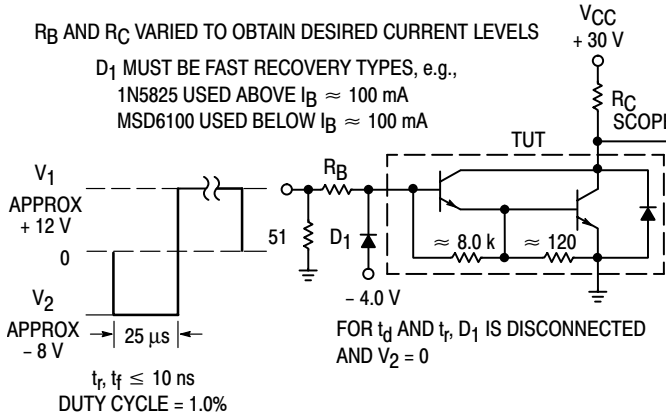

Figure 2. Switching Times Test Circuit

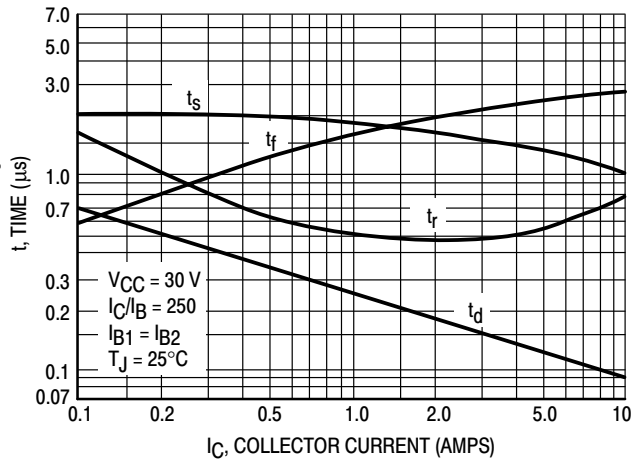

Figure 3. Switching Times

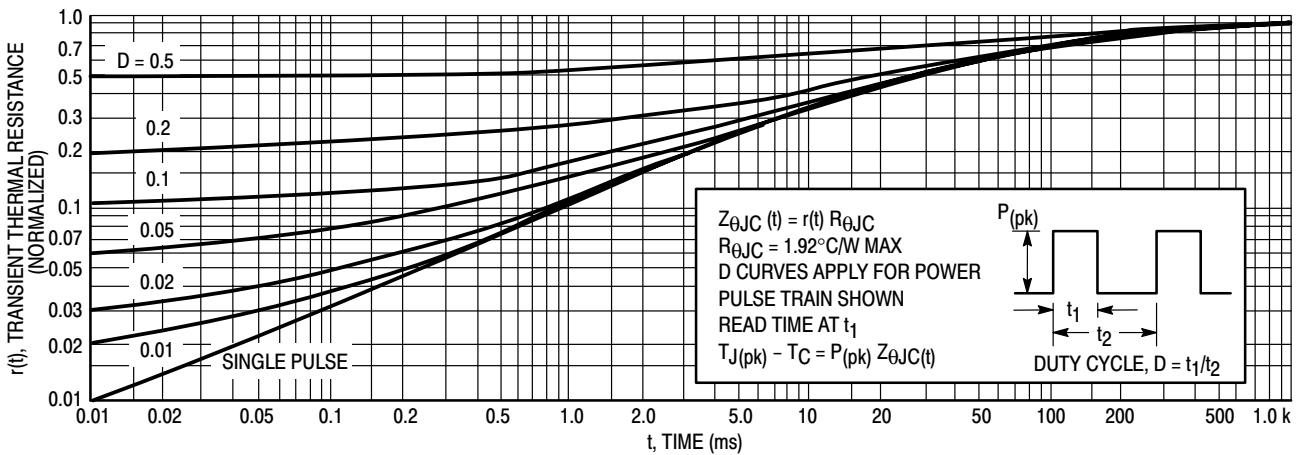

Figure 4. Thermal Response

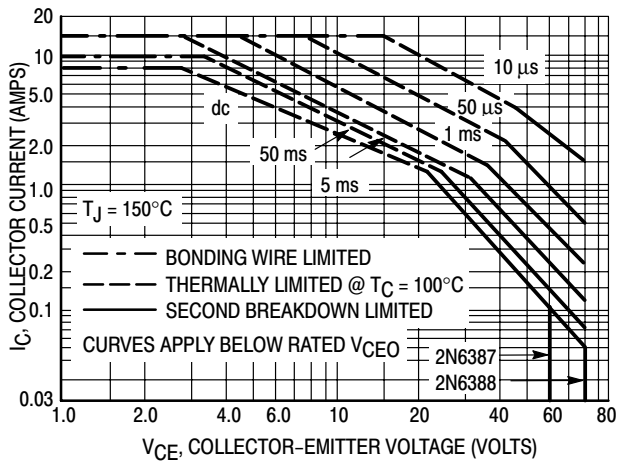

Figure 5. Active-Region Safe Operating Area

There are two limitations on the power handling ability of a transistor: average junction temperature and second breakdown. Safe operating area curves indicate $I_C - V_{CE}$ limits of the transistor that must be observed for reliable operation; i.e., the transistor must not be subjected to greater dissipation than the curves indicate.

The data of Figure 5 is based on $T_{J(pk)} = 150^\circ\text{C}$; T_C is variable depending on conditions. Second breakdown pulse limits are valid for duty cycles to 10% provided $T_{J(pk)} < 150^\circ\text{C}$. $T_{J(pk)}$ may be calculated from the data in Figure 4. At high case temperatures, thermal limitations will reduce the power that can be handled to values less than the limitations imposed by second breakdown

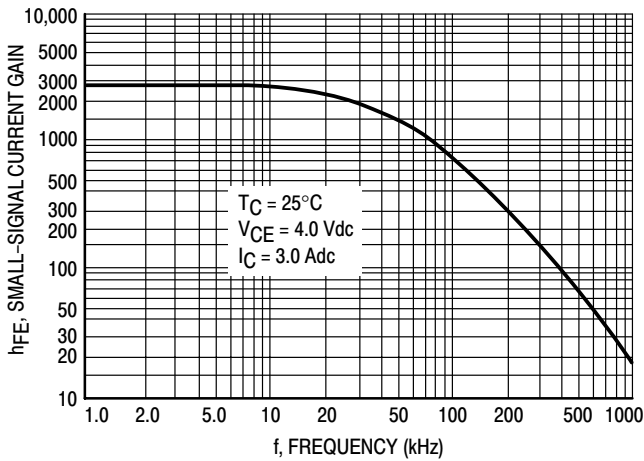

Figure 6. Small-Signal Current Gain

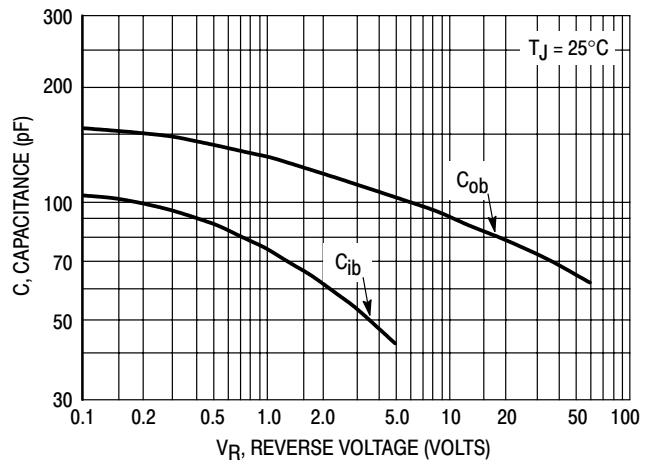

Figure 7. Capacitance

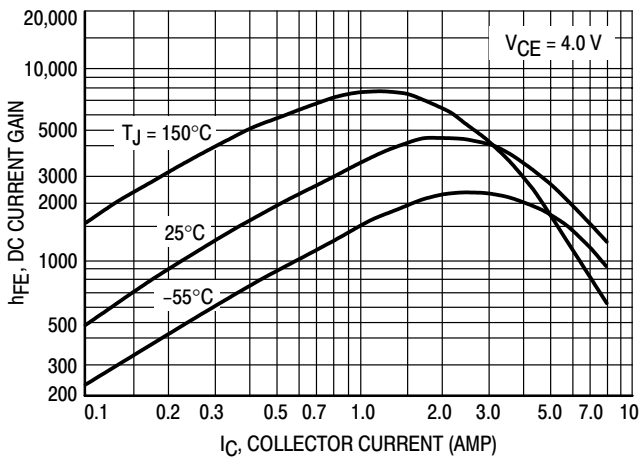

Figure 8. DC Current Gain

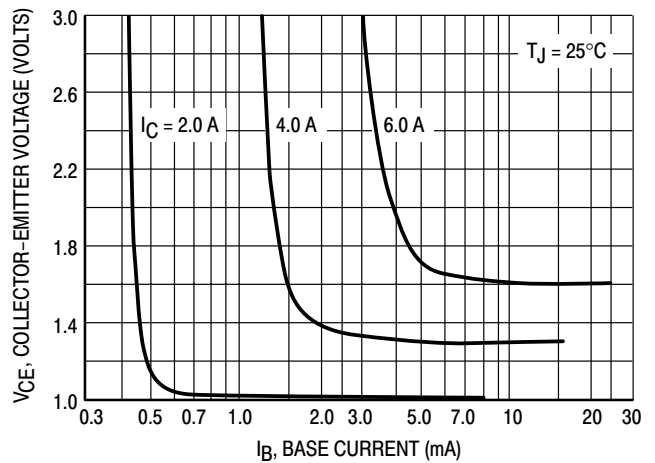

Figure 9. Collector Saturation Region

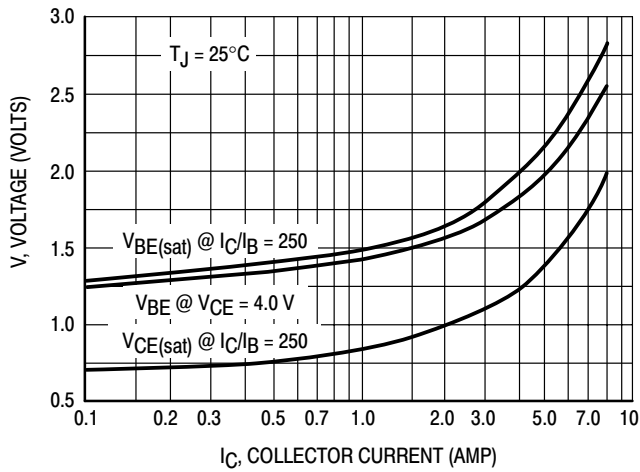

Figure 10. "On" Voltages

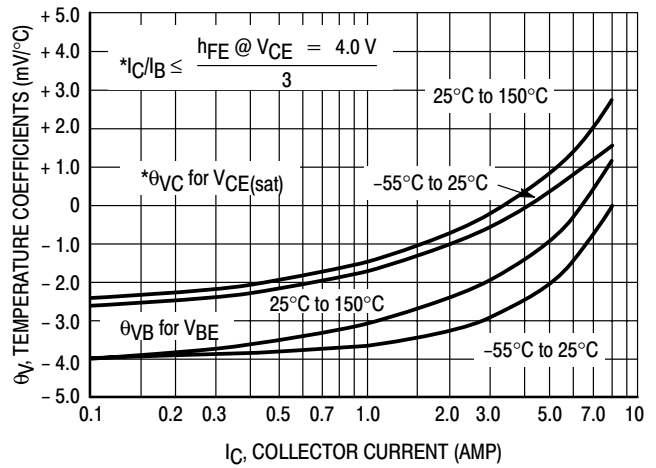

Figure 11. Temperature Coefficients

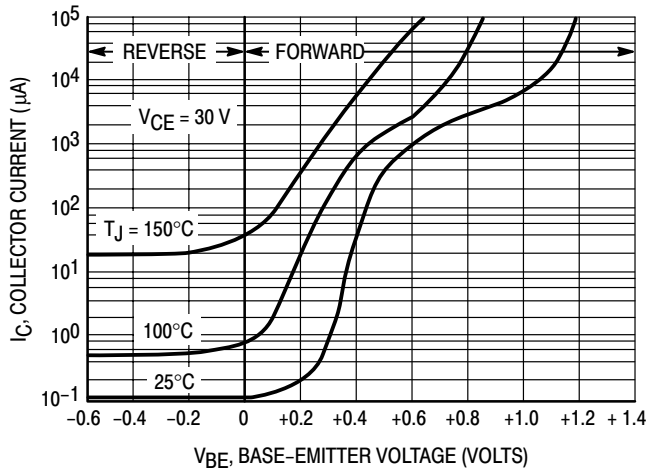

Figure 12. Collector Cut-Off Region

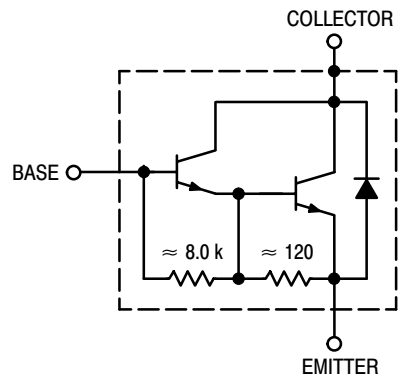
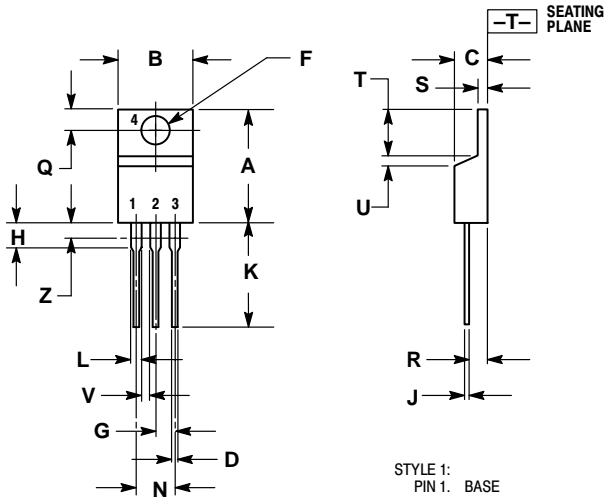

Figure 13. Darlington Schematic

2N6387 2N6388

PACKAGE DIMENSIONS

TO-220AB CASE 221A-09 ISSUE AA



STYLE 1:
PIN 1. BASE
2. COLLECTOR
3. EMITTER
4. COLLECTOR

NOTES:

1. DIMENSIONING AND TOLERANCING PER ANSI Y14.5M, 1982.
2. CONTROLLING DIMENSION: INCH.
3. DIMENSION Z DEFINES A ZONE WHERE ALL BODY AND LEAD IRREGULARITIES ARE ALLOWED.

DIM	INCHES		MILLIMETERS	
	MIN	MAX	MIN	MAX
A	0.570	0.620	14.48	15.75
B	0.380	0.405	9.66	10.28
C	0.160	0.190	4.07	4.82
D	0.025	0.035	0.64	0.88
F	0.142	0.147	3.61	3.73
G	0.095	0.105	2.42	2.66
H	0.110	0.155	2.80	3.93
J	0.018	0.025	0.46	0.64
K	0.500	0.562	12.70	14.27
L	0.045	0.060	1.15	1.52
N	0.190	0.210	4.83	5.33
Q	0.100	0.120	2.54	3.04
R	0.080	0.110	2.04	2.79
S	0.045	0.055	1.15	1.39
T	0.235	0.255	5.97	6.47
U	0.000	0.050	0.00	1.27
V	0.045	---	1.15	---
Z	---	0.080	---	2.04

ON Semiconductor and  are registered trademarks of Semiconductor Components Industries, LLC (SCILLC). SCILLC reserves the right to make changes without further notice to any products herein. SCILLC makes no warranty, representation or guarantee regarding the suitability of its products for any particular purpose, nor does SCILLC assume any liability arising out of the application or use of any product or circuit, and specifically disclaims any and all liability, including without limitation special, consequential or incidental damages. "Typical" parameters which may be provided in SCILLC data sheets and/or specifications can and do vary in different applications and actual performance may vary over time. All operating parameters, including "Typicals" must be validated for each customer application by customer's technical experts. SCILLC does not convey any license under its patent rights nor the rights of others. SCILLC products are not designed, intended, or authorized for use as components in systems intended for surgical implant into the body, or other applications intended to support or sustain life, or for any other application in which the failure of the SCILLC product could create a situation where personal injury or death may occur. Should Buyer purchase or use SCILLC products for any such unintended or unauthorized application, Buyer shall indemnify and hold SCILLC and its officers, employees, subsidiaries, affiliates, and distributors harmless against all claims, costs, damages, and expenses, and reasonable attorney fees arising out of, directly or indirectly, any claim of personal injury or death associated with such unintended or unauthorized use, even if such claim alleges that SCILLC was negligent regarding the design or manufacture of the part. SCILLC is an Equal Opportunity/Affirmative Action Employer.

PUBLICATION ORDERING INFORMATION

Literature Fulfillment:

Literature Distribution Center for ON Semiconductor
P.O. Box 5163, Denver, Colorado 80217 USA
Phone: 303-675-2175 or 800-344-3860 Toll Free USA/Canada
Fax: 303-675-2176 or 800-344-3867 Toll Free USA/Canada
Email: ONlit@hibbertco.com

N. American Technical Support: 800-282-9855 Toll Free USA/Canada

JAPAN: ON Semiconductor, Japan Customer Focus Center
4-32-1 Nishi-Gotanda, Shinagawa-ku, Tokyo, Japan 141-0031
Phone: 81-3-5740-2700
Email: r14525@onsemi.com

ON Semiconductor Website: <http://onsemi.com>

For additional information, please contact your local Sales Representative.