

DESCRIPTION The 2SC3732 is designed for general purpose amplifier and high speed switching applications.

- FEATURES**
- High Frequency Current Gain.
 - High Speed Switching.
 - Small Output Capacitance.

ABSOLUTE MAXIMUM RATINGS

Maximum Temperatures	
Storage Temperature	-55 to +150 °C
Junction Temperature	150 °C Maximum
Maximum Power Dissipation (T _a = 25 °C)	
Total Power Dissipation	250 mW
Maximum Voltages and Currents (T _a = 25 °C)	
V _{CB0} Collector to Base Voltage	40 V
V _{CES} Collector to Emitter Voltage	40 V
V _{CEO} Collector to Emitter Voltage	15 V
V _{EBO} Emitter to Base Voltage	5.0 V
I _C Collector Current	200 mA
I _C Collector Current (10 μs pulse)	500 mA

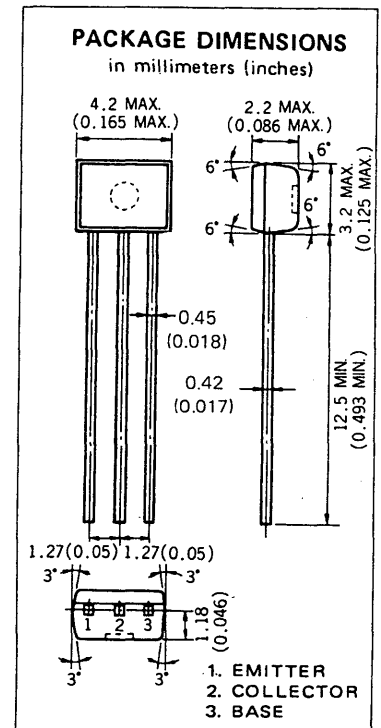

ELECTRICAL CHARACTERISTICS (T_a = 25 °C)

SYMBOL	CHARACTERISTIC	MIN.	TYP.	MAX.	UNIT	TEST CONDITIONS
t _{on}	Turn-on Time		8.0	12	ns	V _{CC} = 3.0 V, I _C = 10 mA, I _{B1} = 3.0 mA, V _{BE} = -1.5 V
t _{off}	Turn-off Time		12	18	ns	V _{CC} = 3.0 V, I _C = 10 mA, I _{B1} = 3.0 mA, I _{B2} = -1.5 mA
t _{stg}	Storage Time		6.0	13	ns	I _C = 10 mA, I _{B1} = -I _{B2} = 10 mA
f _T	Gain Bandwidth Product	500	750		MHz	V _{CE} = 10 V, I _E = -10 mA, f = 100 MHz
C _{ob}	Output Capacitance		1.8	4.0	pF	V _{CB} = 5.0 V, I _E = 0, f = 1 MHz
h _{FE} *	DC Current Gain	40	90	200	-	V _{CE} = 1.0 V, I _C = 10 mA
V _{CE(sat)} *	Collector Saturation Voltage		0.15	0.25	V	I _C = 10 mA, I _B = 1.0 mA
V _{BE(sat)} *	Base Saturation Voltage		0.80	0.85	V	I _C = 10 mA, I _B = 1.0 mA
I _{CBO}	Collector Cutoff Current			0.1	μA	V _{CB} = 20 V, I _E = 0
I _{EBO}	Emitter Cutoff Current			0.1	μA	V _{EB} = 3.0 V, I _C = 0

* Pulsed PW ≤ 350 μs, Duty Cycle ≤ 2 %

Classification of h_{FE}

Rank	M	L	K
Range	40 to 80	60 to 120	100 to 200

Test Conditions : V_{CE} = 1.0 V, I_C = 10 mA

TYPICAL CHARACTERISTICS ($T_a = 25^\circ\text{C}$)

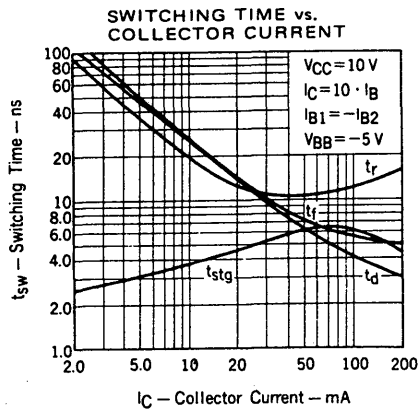
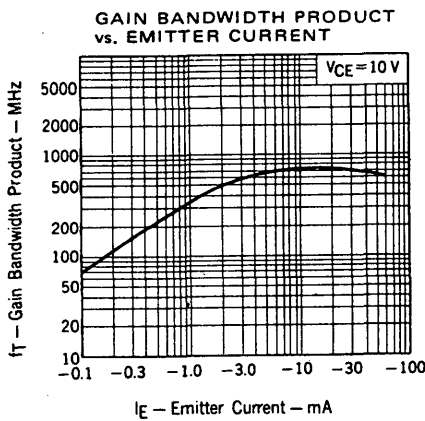
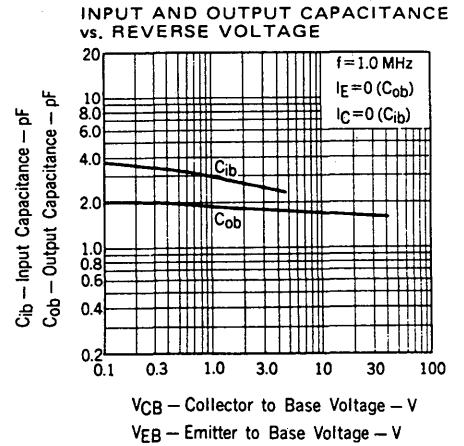
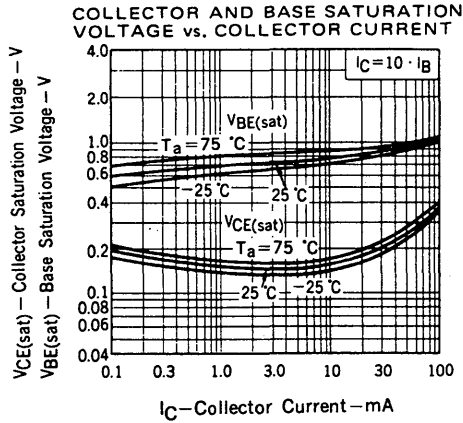
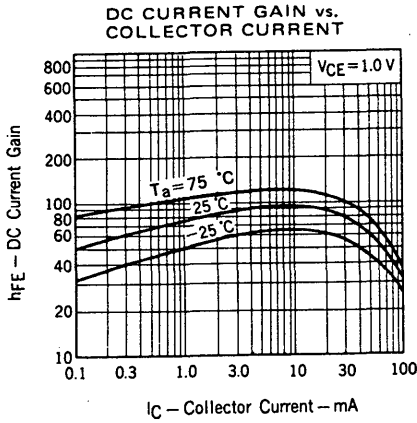
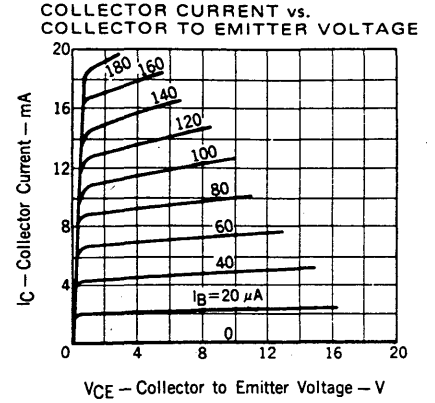
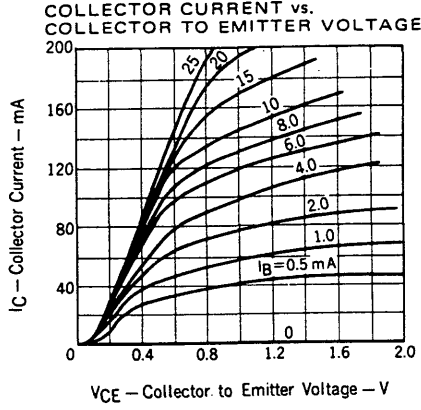
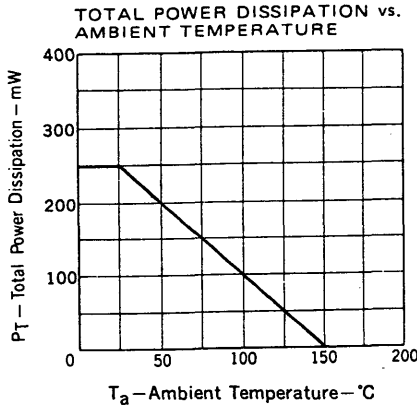

SWITCHING TIME TEST CIRCUIT

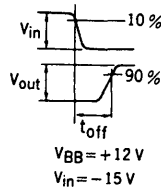
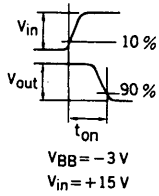
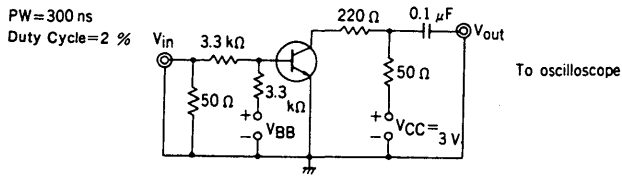

t_{on} , t_{off} SWITCHING

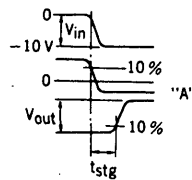
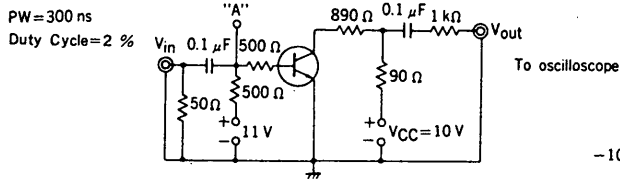

t_{stg} SWITCHING

Voltage waveforms