

SANYO	No.2761	2SC4222
	NPN Triple Diffused Planar Silicon Transistor Switching Regulator Applications	

Features

- . High breakdown voltage, high reliability
- . Fast switching speed ($t_f: 0.1\mu s$ typ)
- . Wide ASO
- . Adoption of MBIT process
- . Suitable for sets whose height is restricted

Absolute Maximum Ratings at $T_a=25^\circ C$

			unit	
Collector to Base Voltage	V_{CB0}	800	V	
Collector to Emitter Voltage	V_{CE0}	500	V	
Emitter to Base Voltage	V_{EB0}	7	V	
Collector Current	I_C	5	A	
Peak Collector Current	i_{cp} $PW \leq 300\mu s, \text{duty cycle} \leq 10\%$	10	A	
Base Current	I_B	2	A	
Collector Dissipation	P_C	$T_a=25^\circ C$	1.65	W
		$T_c=25^\circ C$	50	W
Junction Temperature	T_j	150	$^\circ C$	
Storage Temperature	T_{stg}	-55 to +150	$^\circ C$	

Electrical Characteristics at $T_a=25^\circ C$

			min	typ	max	unit
Collector Cutoff Current	I_{CB0}	$V_{CB}=500V, I_E=0$			10	μA
Emitter Cutoff Current	I_{EB0}	$V_{EB}=5V, I_C=0$			10	μA
DC Current Gain	$h_{FE(1)}$	$V_{CE}=5V, I_C=0.6A$	15*		50*	
			8			
Gain-Bandwidth Product	f_T	$V_{CE}=10V, I_C=0.6A$		18		MHz
Output Capacitance	c_{ob}	$V_{CB}=10V, f=1MHz$		80		pF

Continued on next page.

*: The $h_{FE(1)}$ of the 2SC4222 is classified as follows. When specifying the $h_{FE(1)}$ rank, specify two ranks or more in principle.

15	L	30	20	M	40	30	N	50
----	---	----	----	---	----	----	---	----

Package Dimensions 2049
(unit: mm)

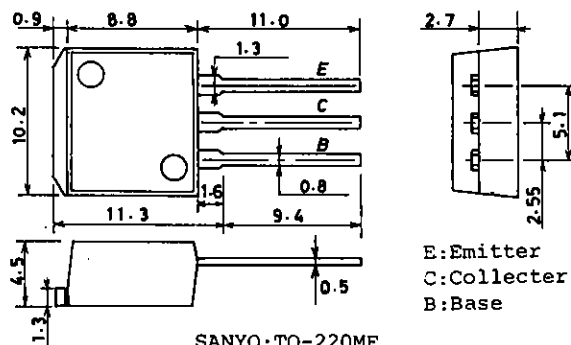

Continued from preceding page.

			min	typ	max	unit
C-E Saturation Voltage	$V_{CE(sat)}$	$I_C=3A, I_B=0.6A$			1.0	V
B-E Saturation Voltage	$V_{BE(sat)}$	$I_C=3A, I_B=0.6A$			1.5	V
C-B Breakdown Voltage	$V_{(BR)CBO}$	$I_C=1mA, I_E=0$	800			V
C-E Breakdown Voltage	$V_{(BR)CEO}$	$I_C=5mA, R_{BE}=\infty$	500			V
E-B Breakdown Voltage	$V_{(BR)EBO}$	$I_E=1mA, I_C=0$	7			V
C-E Sustain Voltage	$V_{CEO(sus)}$	$I_C=5A, I_B=1A, L=50\mu H$	500			V
	$V_{CEX(sus)}$	$I_C=2.5A, I_{B1}=-I_{B2}=1A, L=1mH, \text{clamped}$	500			V
Rise Time	t_{on}	$I_C=4A, I_{B1}=0.8A, I_{B2}=-1.6A, R_L=50\text{ohms}, V_{CC}=200V$			0.5	μs
Storage Time	t_{stg}				3.0	μs
Fall Time	t_f				0.3	μs

Switching Time Test Circuit

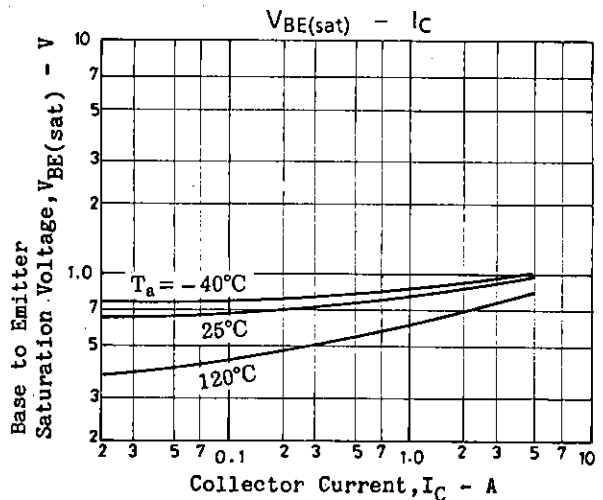
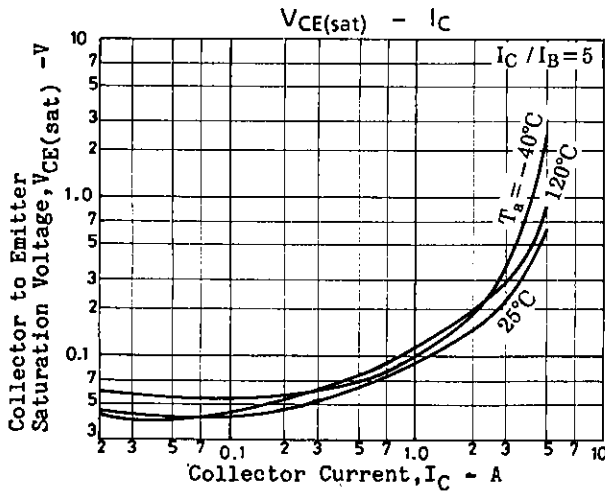
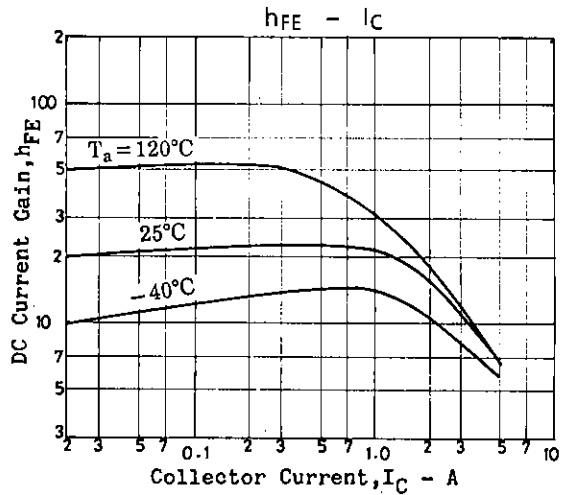
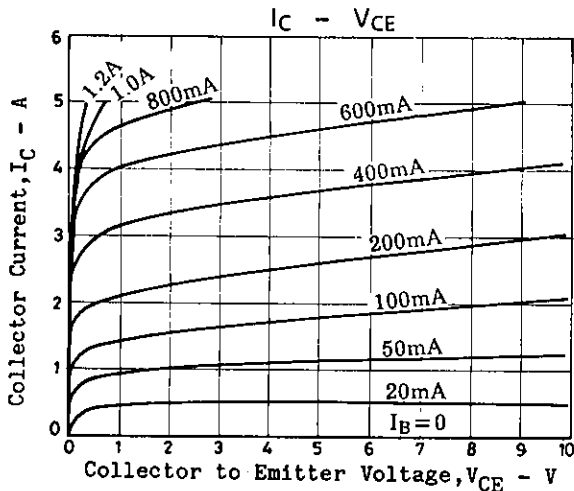
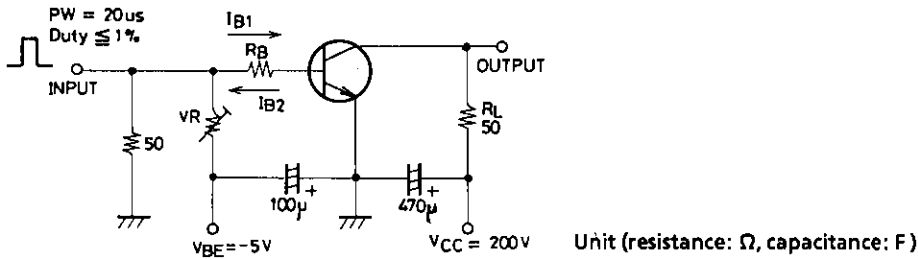

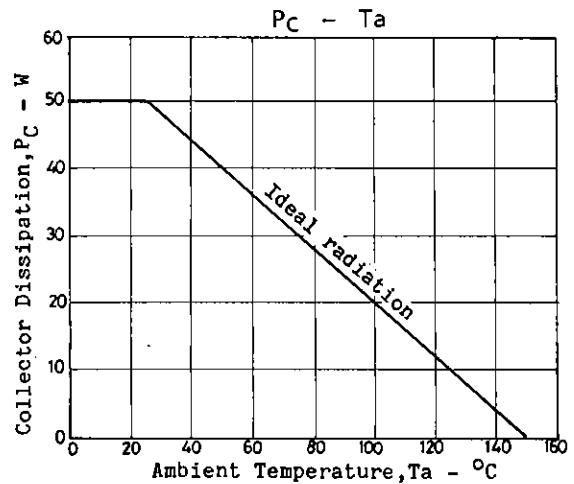
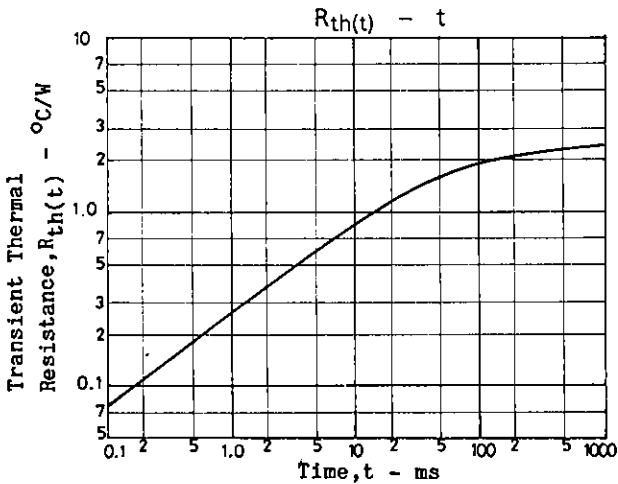
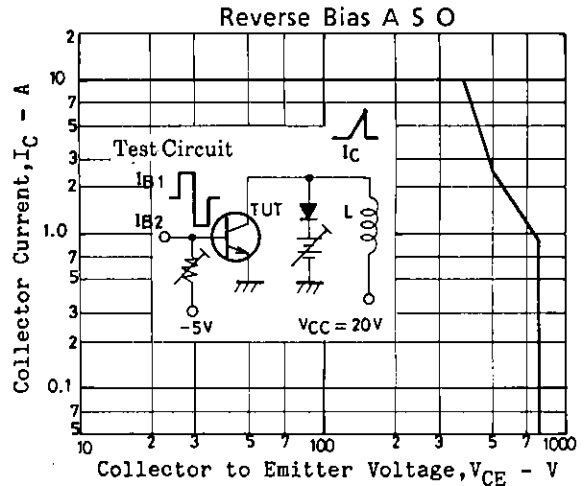
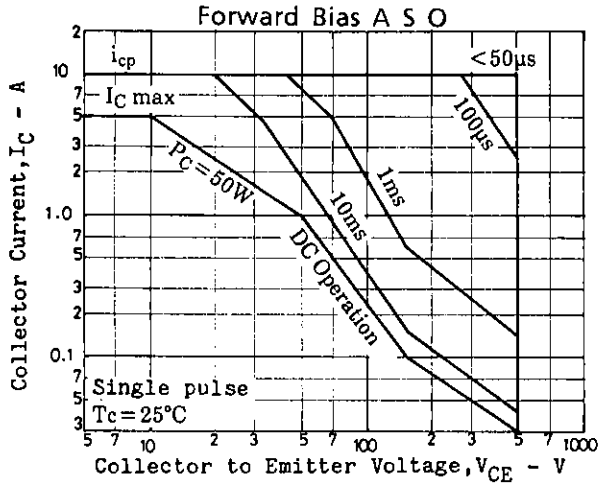
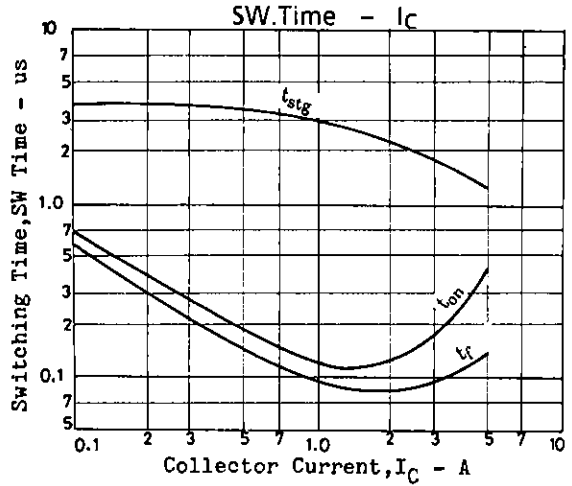
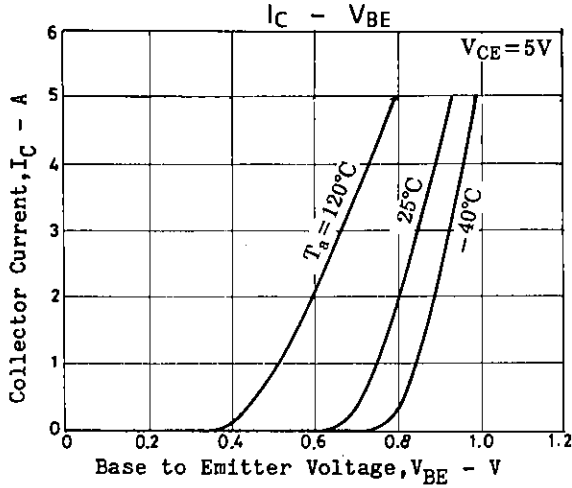

- No products described or contained herein are intended for use in surgical implants, life-support systems, aerospace equipment, nuclear power control systems, vehicles, disaster/crime-prevention equipment and the like, the failure of which may directly or indirectly cause injury, death or property loss.
- Anyone purchasing any products described or contained herein for an above-mentioned use shall:
 - ① Accept full responsibility and indemnify and defend SANYO ELECTRIC CO., LTD., its affiliates, subsidiaries and distributors and all their officers and employees, jointly and severally, against any and all claims and litigation and all damages, cost and expenses associated with such use;
 - ② Not impose any responsibility for any fault or negligence which may be cited in any such claim or litigation on SANYO ELECTRIC CO., LTD., its affiliates, subsidiaries and distributors or any of their officers and employees jointly or severally.
- Information (including circuit diagrams and circuit parameters) herein is for example only; it is not guaranteed for volume production. SANYO believes information herein is accurate and reliable, but no guarantees are made or implied regarding its use or any infringements of intellectual property rights or other rights of third parties.