



2SD1616/A

NPN SILICON TRANSISTOR

NPN EPITAXIAL SILICON TRANSISTOR

■ DESCRIPTION

- * Audio frequency power amplifier
- * Medium speed switching

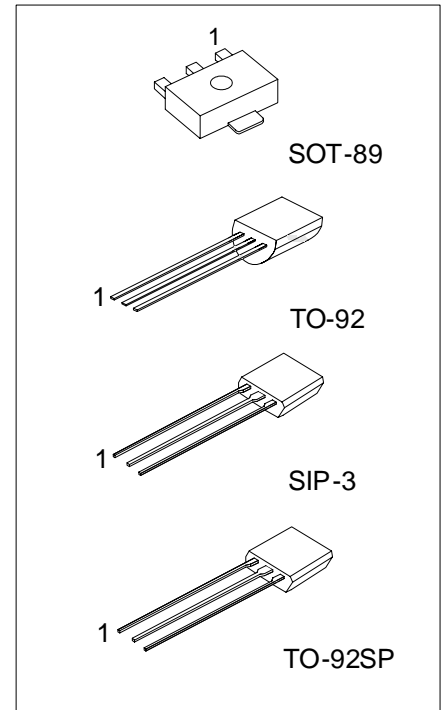

*Pb-free plating product number:
2SD1616L/2SD1616AL

■ ORDERING INFORMATION

Order Number		Package	Pin Assignment			Packing
Normal	Lead Free Plating		1	2	3	
2SD1616-x-AB3-R	2SD1616L-x-AB3-R	SOT-89	B	C	E	Tape Reel
2SD1616-x-G03-K	2SD1616L-x-G03-K	SIP-3	E	C	B	Bulk
2SD1616-x-T92-B	2SD1616L-x-T92-B	TO-92	E	C	B	Tape Box
2SD1616-x-T92-K	2SD1616L-x-T92-K	TO-92	E	C	B	Bulk
2SD1616-x-T9S-K	2SD1616L-x-T9S-K	TO-92SP	E	C	B	Bulk
2SD1616A-x-AB3-R	2SD1616AL-x-AB3-R	SOT-89	B	C	E	Tape Reel
2SD1616A-x-G03-K	2SD1616AL-x-G03-K	SIP-3	E	C	B	Bulk
2SD1616A-x-T92-B	2SD1616AL-x-T92-B	TO-92	E	C	B	Tape Box
2SD1616A-x-T92-K	2SD1616AL-x-T92-K	TO-92	E	C	B	Bulk
2SD1616A-x-T9S-K	2SD1616AL-x-T9S-K	TO-92SP	E	C	B	Bulk

<p>2SD1616L-x-AB3-T</p>	<p>(1) Packing Type (2) Package Type (3) Rank (4) Lead Plating</p> <p>(1) B: Tape Box, K: Bulk, R: Tape Reel, T: Tube (2) AB3: SOT-89, G03: SIP-3, T92: TO-92, T9S: TO-92S (3) x: refer to Classification of h_{FE1} (4) L: Lead Free Plating, Blank: Pb/Sn</p>
-------------------------	--

■ ABSOLUTE MAXIMUM RATINGS (Ta=25°C)

PARAMETER	SYMBOL	RATINGS	UNIT
Collector to Base Voltage	2SD1616	60	V
	2SD1616A	120	
Collector to Emitter Voltage	2SD1616	50	V
	2SD1616A	60	
Emitter to Base Voltage	V _{EBO}	6	V
Collector Current	DC	1	A
	Pulse(Note2)	2	A
Total Power Dissipation	P _C	750	mW
Junction Temperature	T _J	+150	°C
Storage Temperature	T _{STG}	-55 ~ +150	°C

Note: 1. Absolute maximum ratings are those values beyond which the device could be permanently damaged.

Absolute maximum ratings are stress ratings only and functional device operation is not implied.

2. Pulse width ≤ 10ms, Duty cycle < 50%

■ ELECTRICAL CHARACTERISTICS (Ta=25°C, unless otherwise specified.)

PARAMETER	SYMBOL	TEST CONDITIONS	MIN	TYP	MAX	UNIT
Collector-Emitter Saturation Voltage	V _{CE(SAT)}	I _C =1A, I _B =50mA		0.15	0.3	V
Base-Emitter Saturation Voltage	V _{BE(SAT)}	I _C =1A, I _B =50mA		0.9	1.2	V
Base Emitter On Voltage	V _{BE(ON)}	V _{CE} =2V, I _C =50mA	600	640	700	mV
Collector Cut-Off Current	I _{CBO}	V _{CB} =60V			100	nA
Emitter Cut-Off Current	I _{EBO}	V _{EB} =6V			100	nA
DC Current Gain	h _{FE1}	V _{CE} =2V, I _C =100mA	2SD1616	135	600	
			2SD1616A	135	400	
	h _{FE2}	V _{CE} =2V, I _C =1A	81			
Transition Frequency	f _T	V _{CE} =2V, I _C =100mA	100	160		MHz
Output Capacitance	C _{ob}	V _{CB} =10V, f=1MHz			19	pF
Turn On Time	t _{ON}	V _{CE} =10V, I _C =100mA		0.07		μs
Storage Time	t _{STG}	I _{B1} =-I _{B2} =10mA		0.95		μs
Fall Time	t _F	V _{BE(OFF)} =-2 ~ -3V		0.07		μs

■ CLASSIFICATION OF h_{FE1}

RANK	Y	G	L
h _{FE1}	135 ~ 270	200 ~ 400	300 ~ 600

TYPICAL CHARACTERISTICS

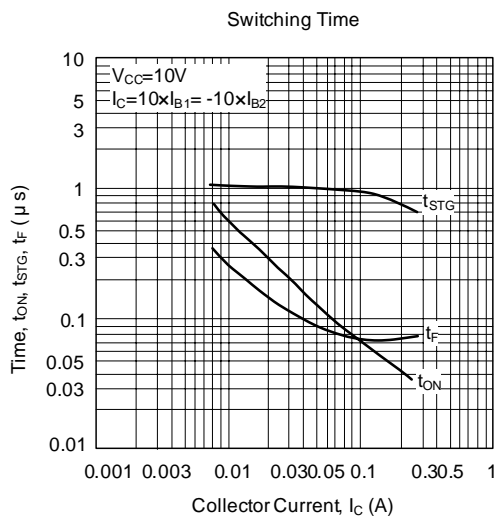
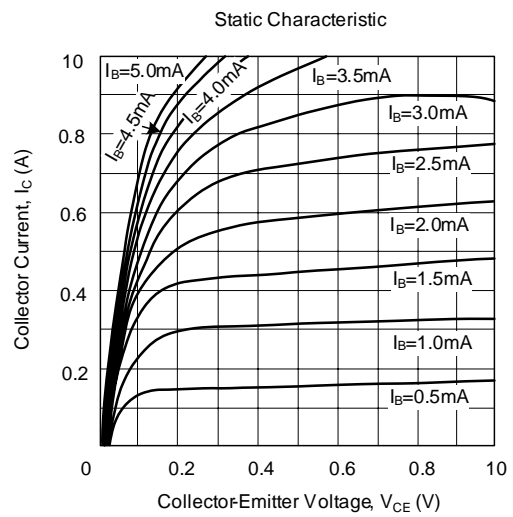
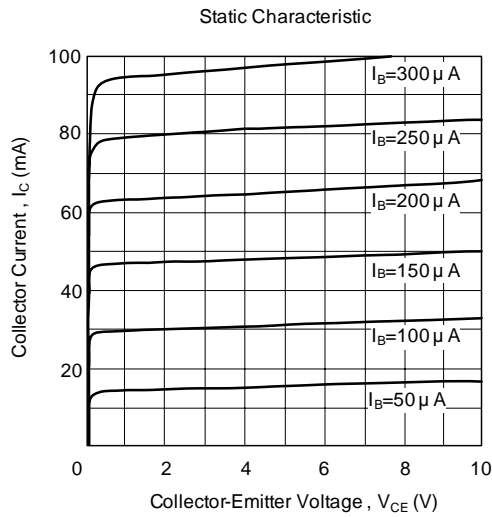
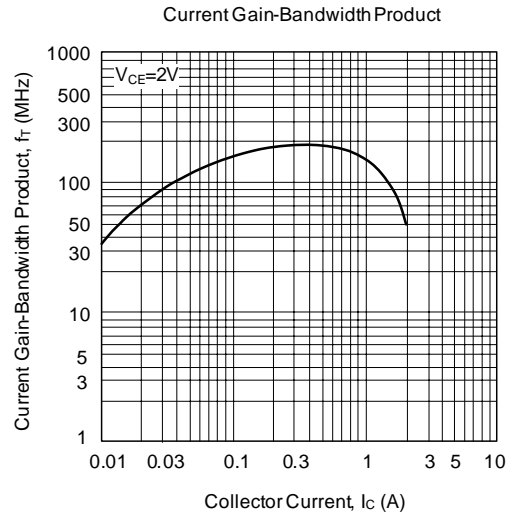
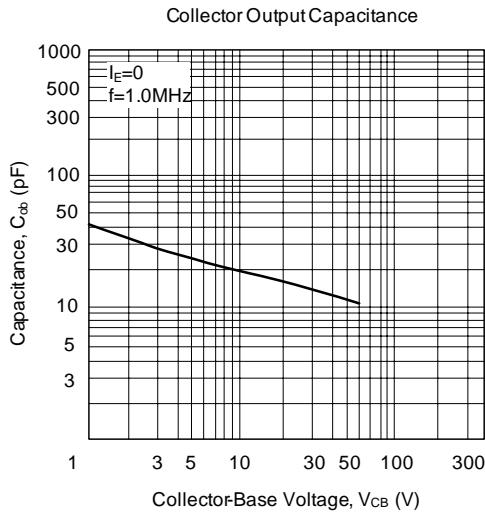

TYPICAL CHARACTERISTICS(Cont.)

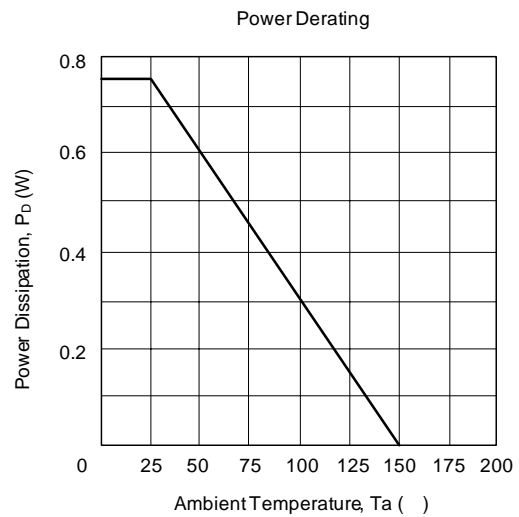
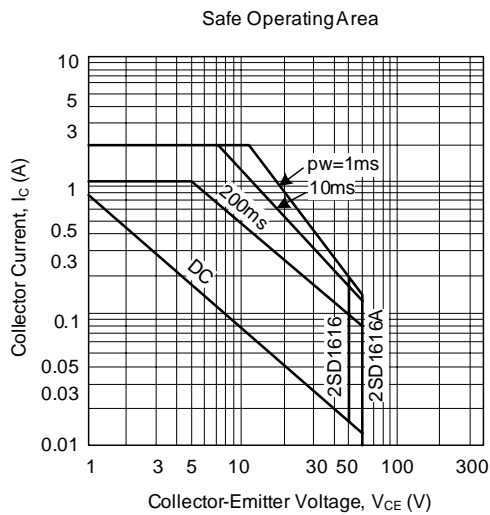
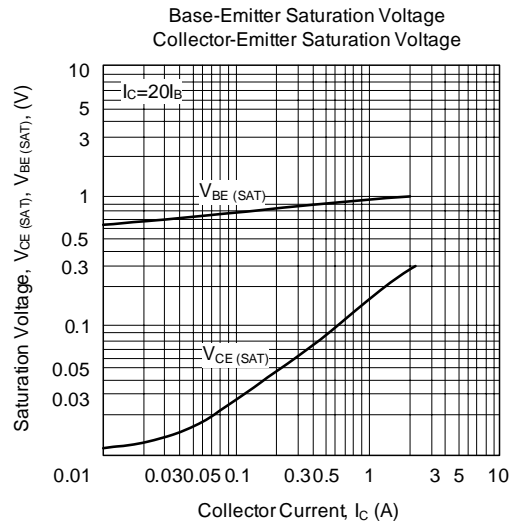
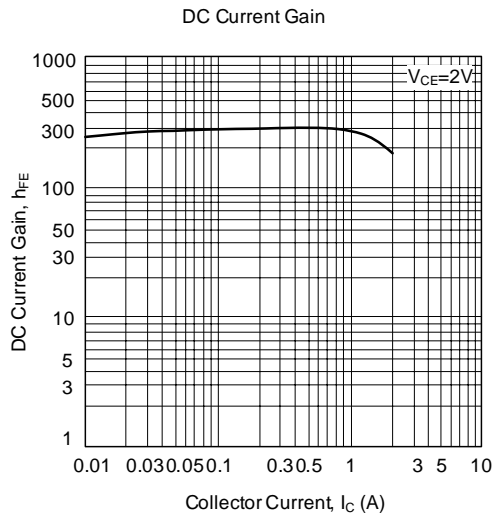

UTC assumes no responsibility for equipment failures that result from using products at values that exceed, even momentarily, rated values (such as maximum ratings, operating condition ranges, or other parameters) listed in products specifications of any and all UTC products described or contained herein. UTC products are not designed for use in life support appliances, devices or systems where malfunction of these products can be reasonably expected to result in personal injury. Reproduction in whole or in part is prohibited without the prior written consent of the copyright owner. The information presented in this document does not form part of any quotation or contract, is believed to be accurate and reliable and may be changed without notice.