

THREE PHASE BRIDGE

Power Module

Features

- Low V_F
- Low profile package
- Direct Mounting to heatsink
- Flat-Pin/ Round-Pin versions with PCB solderable terminals
- Low junction-to-case Thermal Resistance
- 3500 V_{RMS} insulation voltage
- UL approval pending

Applications: Power conversion machines

- Welding
- UPS
- SMPS
- Motor Drives
- General Purpose & Heavy Duty Applications

45 A
75 A
100 A

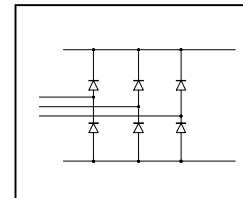

Description

A range of extremely compact three-phase rectifier bridges offering efficient and reliable operation. The low profile package has been specifically conceived to maximize space saving and optimize the electrical layout of the application specific Power Supplies.

Major Ratings and Characteristics

Parameters	40MT	70MT	100MT	Units
I_O	45	75	100	A
@ T_C	100	80	80	°C
I_{FSM}	270	380	450	A
@ 50Hz	280	398	470	
@ 60Hz	365	724	1013	A^2s
I^2t	325	660	920	
@ 50Hz	3650	7240	10130	$A^2\sqrt{s}$
@ 60Hz				
V_{RRM}	1400 & 1600			V
T_{STG} range	-40 to 125			°C
T_J range	-40 to 150			

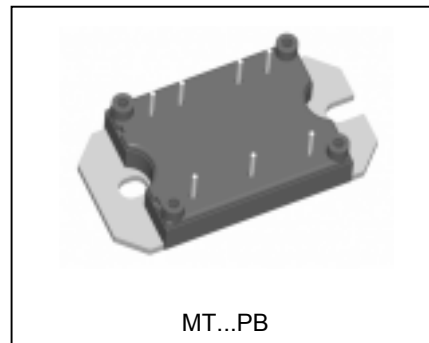
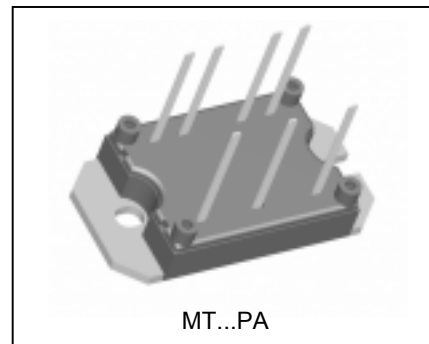

ELECTRICAL SPECIFICATIONS

Voltage Ratings

Type number	Voltage Code reverse voltage V	V_{RRM} , maximum repetitive peak reverse voltage V	V_{RSM} , maximum non-repetitive peak V	I_{RRM} max. @ $T_J = 150^\circ\text{C}$ mA
40-70-100MT140P	140	1400	1500	5
40-70-100MT160P	160	1600	1700	

Forward Conduction

Parameter	40MT	70MT	100MT	Units	Conditions
I_O Maximum DC output current @ Case temperature	45	75	100	A	120° Rect conduction angle
	100	80	80	°C	
I_{FSM} Maximum peak, one-cycle forward, non-repetitive on state surge current	270	380	450	A	t = 10ms No voltage reappplied
	280	398	470		t = 8.3ms
	225	320	380		t = 10ms 100% V_{RRM} reappplied
	240	335	400		t = 8.3ms
I^2t Maximum I^2t for fusing	365	724	1013	A ² s	t = 10ms No voltage reappplied
	325	660	920		t = 8.3ms
	253	512	600		t = 10ms 100% V_{RRM} reappplied
	240	467	665		t = 8.3ms
$I^2\sqrt{t}$ Maximum $I^2\sqrt{t}$ for fusing	3650	7240	10130	A ² √s	t = 0.1 to 10ms, no voltage reappplied
$V_{F(TO)}$ Value of threshold voltage	0.78	0.82	0.75	V	@ T_J max.
r_t Slope resistance	14.8	9.5	8.1	mΩ	
V_{FM} Maximum forward voltage drop	1.45 $I_{pk} = 40A$	1.45 $I_{pk} = 70A$	1.51 $I_{pk} = 100A$	V	$T_J = 25^\circ\text{C}$ $t_p = 400\mu\text{s}$ single junction

Insulation Table

Parameter	40MT	70MT	100MT	Units	Conditions
V_{INS} RMS insulation voltage	3500			V	$T_J = 25^\circ\text{C}$ all terminal shorted f = 50Hz, t = 1s

Thermal and Mechanical Specifications

Parameter	40MT	70MT	100MT	Units	Conditions
T _J Maximum junction operating temperature range	- 40 to 150			°C	
T _{stg} Maximum storage temperature range	-40 to 125			°C	
R _{thJC} Maximum thermal resistance, junction to case	0.27	0.23	0.19	K/W	DC operation per module
	1.6	1.38	1.14		DC operation per junction
	0.38	0.29	0.22		120° Rect conduction angle per module
	2.25	1.76	1.29		120° Rect conduction angle per junction
R _{thCS} Maximum thermal resistance, case to heatsink	0.1			K/W	Per module. Mounting surface smooth, flat and greased. Heatsink compound thermal conductivity = 0.42W/mK
T Mounting torque ± 10% to heatsink	4			Nm	A mounting compound is recommended and the torque should be rechecked after a period of 3 hours to allow for the spread of the compound.
wt Approximate weight	65			g	Lubricated threads.

Clearance and Creepage Distances

Parameter	MT...PA	MT...PB	Units
Clearance (external shortest distance in air between terminals which are not internally short circuited together)	10.9	12.3	mm
Creepage distance (shortest distance along external surface of the insulating material between terminals which are not internally short circuited together)	10.9	12.3	mm

Ordering Information Table

Device Code

10	0	MT	160	P	B
①	②	③	④	⑤	

4	= 45A
7	= 75A
10	= 100A

- 1** - Current rating code
- 2** - Circuit configuration code: 0 = 3-Phase Rectifier Bridge
- 3** - Essential part number
- 4** - Voltage code: code x 10 = V_{RRM} (See Voltage Ratings table)
- 5** - Pinout code:

A = Flat pins
 B = Round pins

MTP 3-Phase Rectifier Series

Bulletin I27145 rev. B 06/02

International
IR Rectifier

Outline Table

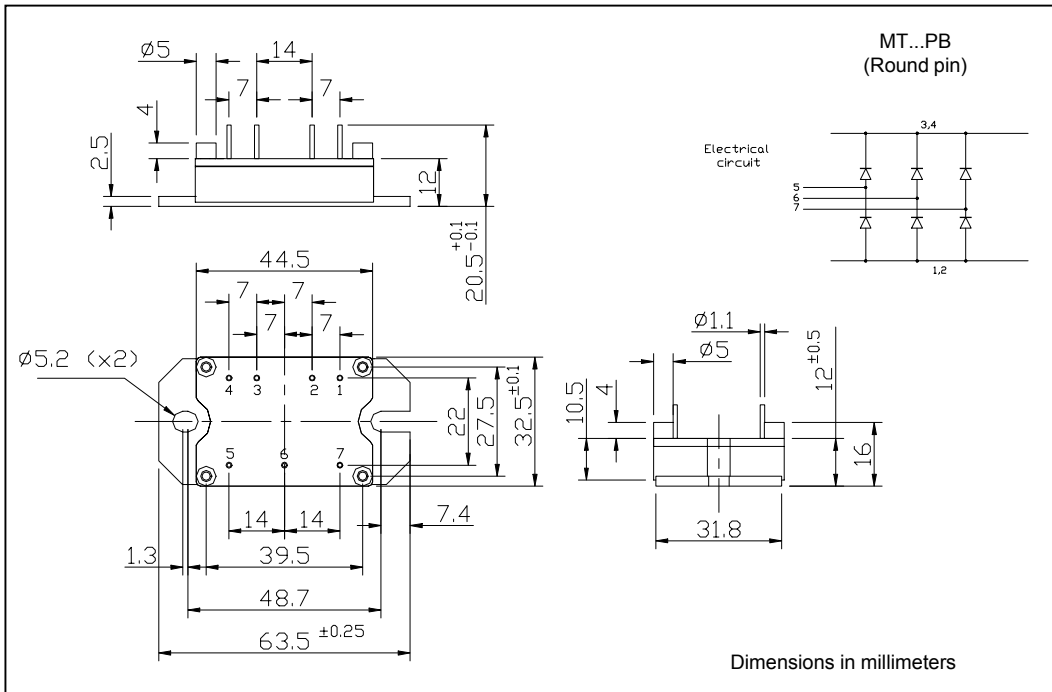
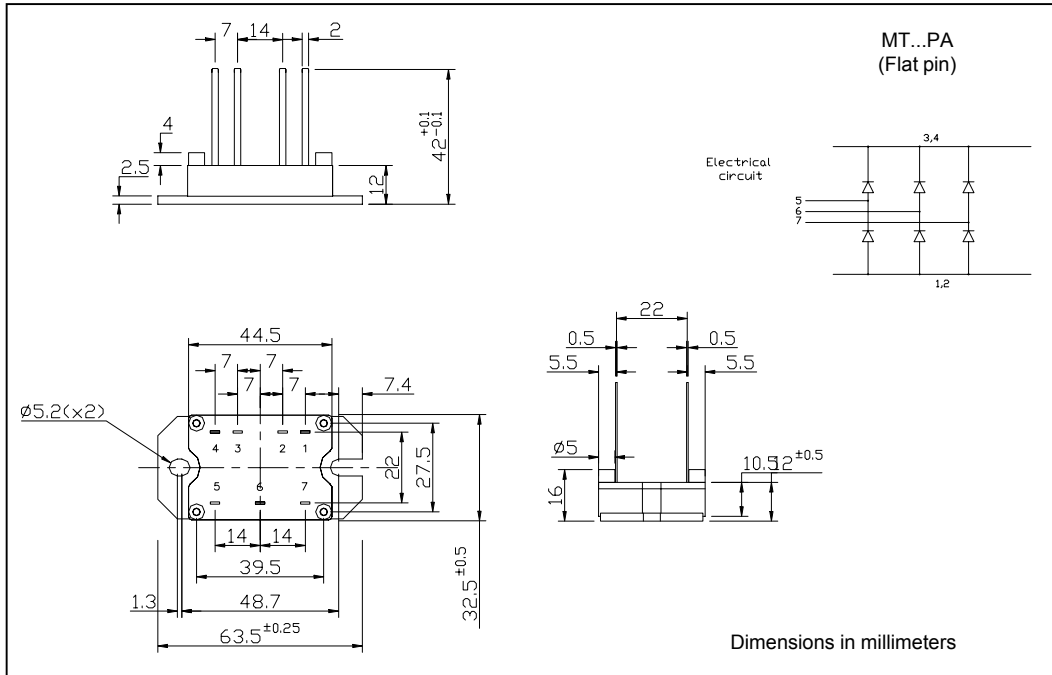

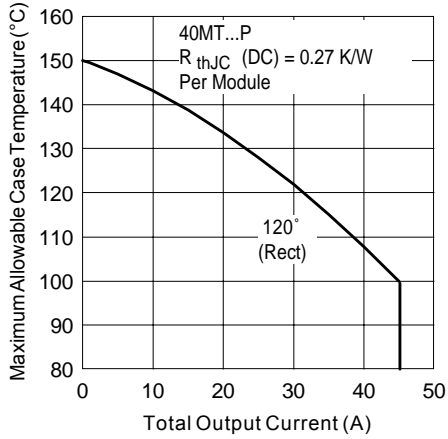

Fig. 1 - Current Rating Characteristics

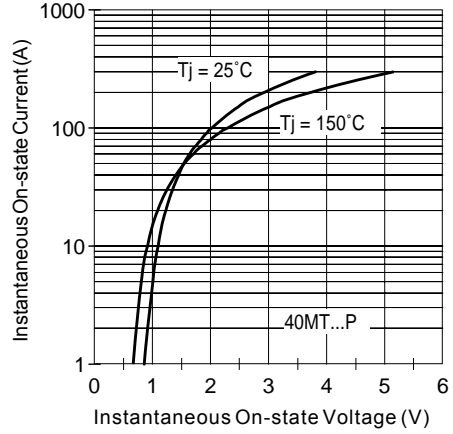

Fig. 2 - On-state Voltage Drop Characteristics

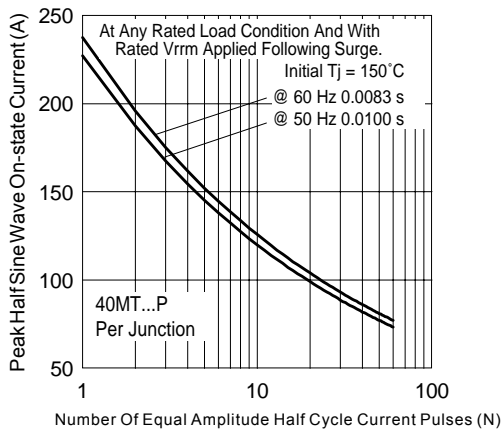

Fig. 3 - Maximum Non-Repetitive Surge Current

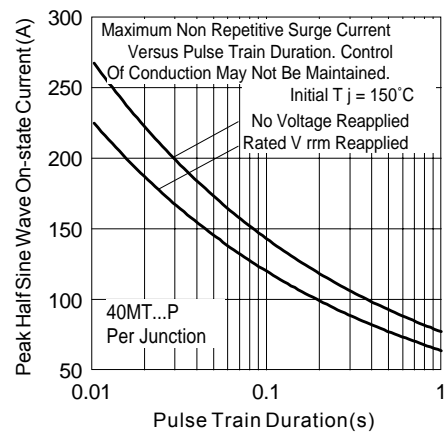

Fig. 4 - Maximum Non-Repetitive Surge Current

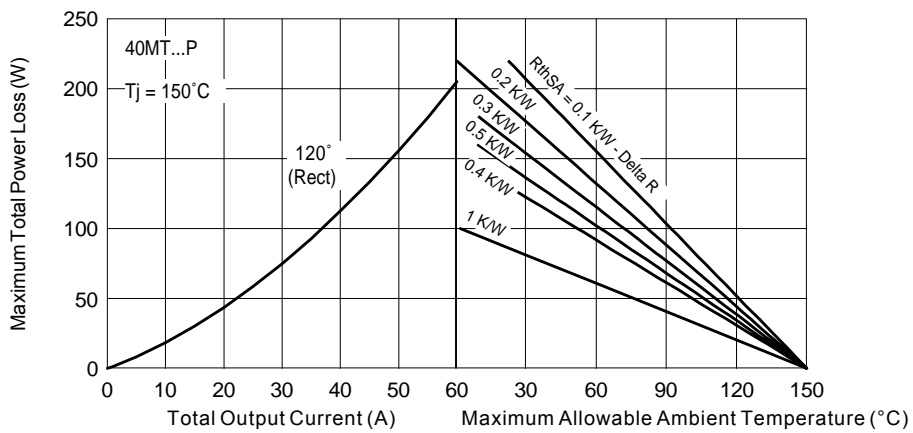

Fig. 5 - Current Rating Nomogram (1 Module Per Heatsink)

MTP 3-Phase Rectifier Series

Bulletin I27145 rev. B 06/02

International
IRF Rectifier

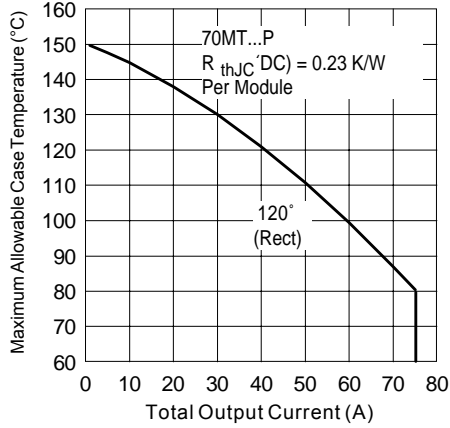

Fig. 6 - Current Rating Characteristics

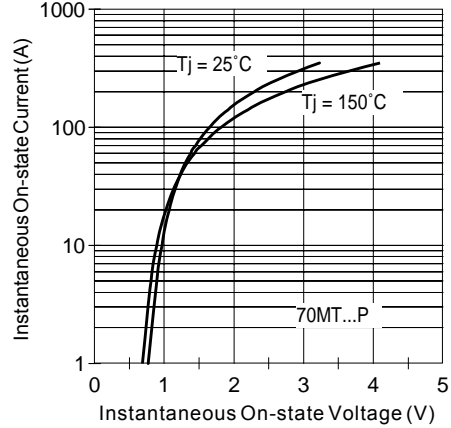

Fig. 7 - On-state Voltage Drop Characteristics

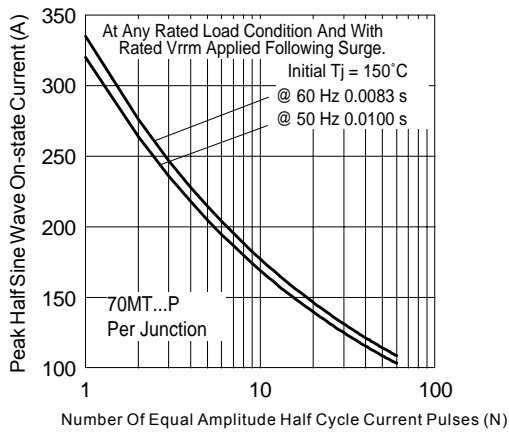

Fig. 8 - Maximum Non-Repetitive Surge Current

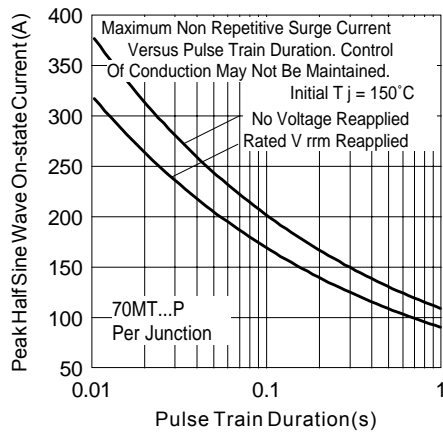

Fig. 9 - Maximum Non-Repetitive Surge Current

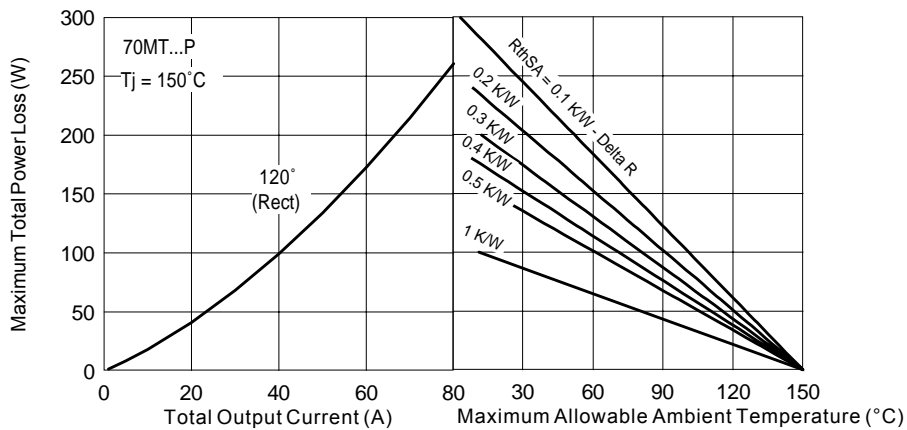

Fig. 10 - Current Rating Nomogram (1 Module Per Heatsink)

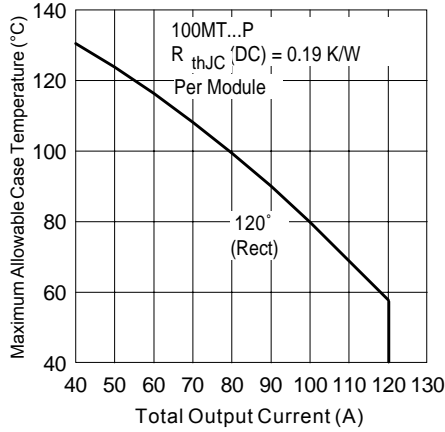

Fig. 11 - Current Rating Characteristics

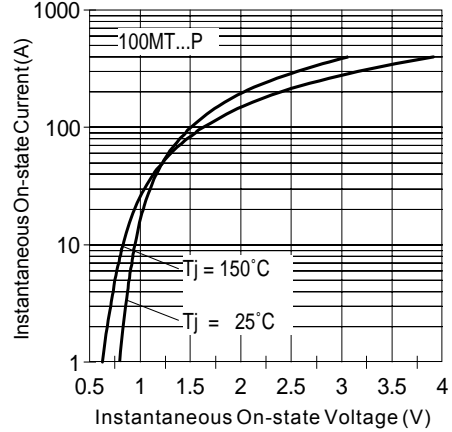

Fig. 12 - On-state Voltage Drop Characteristics

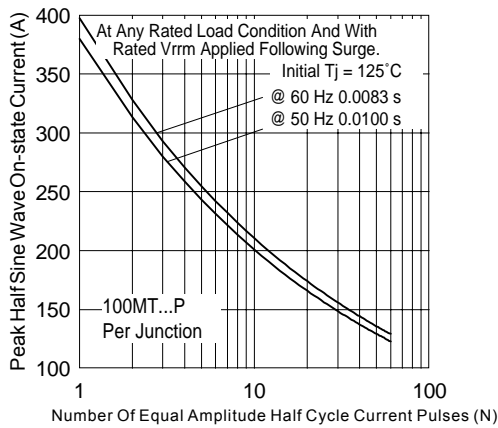

Fig. 13 - Maximum Non-Repetitive Surge Current

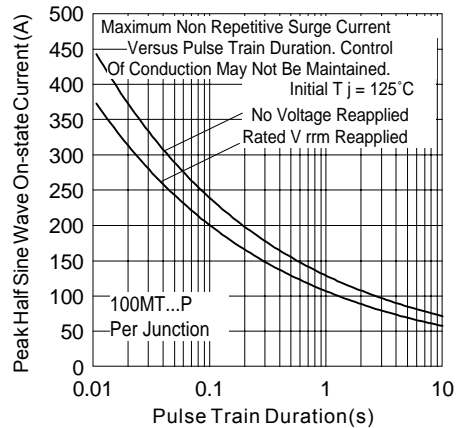

Fig. 14 - Maximum Non-Repetitive Surge Current

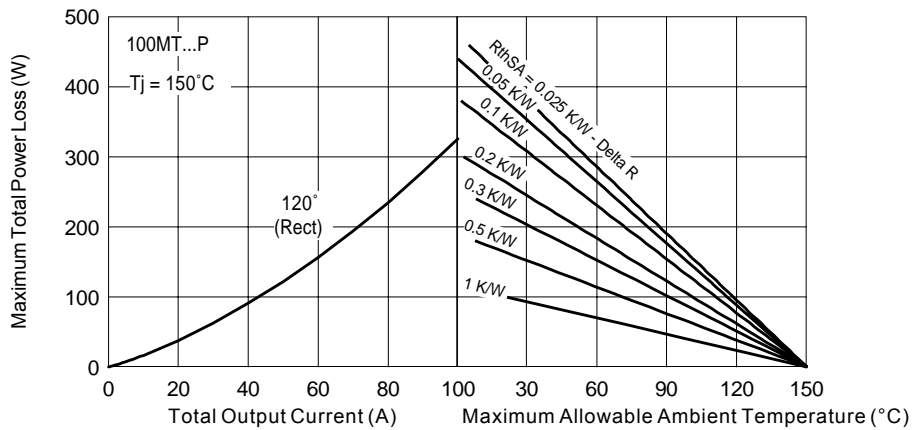

Fig. 15 - Current Rating Nomogram (1 Module Per Heatsink)

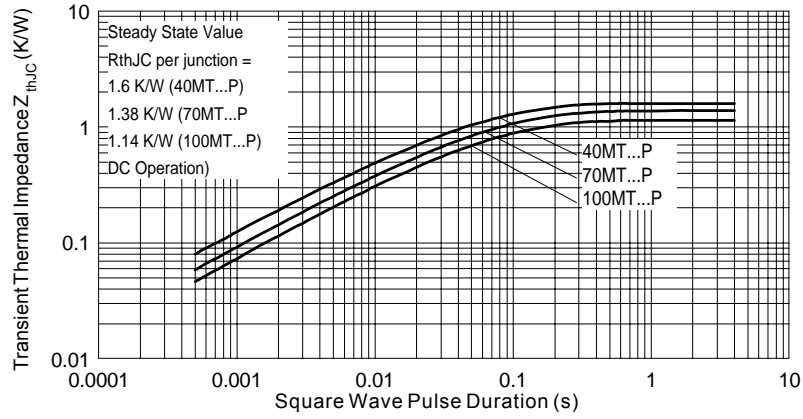

Fig. 16 - Thermal Impedance Z_{thJC} Characteristics

Data and specifications subject to change without notice.
This product has been designed and qualified for Industrial Level.
Qualification Standards can be found on IR's Web site.