

$$I_{F(AV)} = 5.5\text{Amp}$$

$$V_R = 100\text{V}$$

Major Ratings and Characteristics

Characteristics	Values	Units
$I_{F(AV)}$ Rectangular waveform	5.5	A
V_{RRM}	100	V
I_{FSM} @tp = 5 μ s sine	480	A
V_F @5 Apk, $T_J = 125^\circ\text{C}$	0.63	V
T_J range	-40 to 150	$^\circ\text{C}$

Description/ Features

The 50WQ10G surface mount Schottky rectifier has been designed for applications requiring low forward drop and small foot prints on PC board. Typical applications are in disk drives, switching power supplies, converters, free-wheeling diodes, battery charging, and reverse battery protection.

- Popular D-PAK outline
- Small foot print, surface mountable
- Low forward voltage drop
- High frequency operation
- Guard ring for enhanced ruggedness and long term reliability

Case Styles

50WQ10G



D-PAK

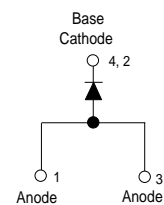

50WQ10G

Preliminary Data Sheet PD-20683 09/04



Voltage Ratings

Part number	50WQ10G
V _R Max. DC Reverse Voltage (V)	100
V _{RWM} Max. Working Peak Reverse Voltage (V)	

Absolute Maximum Ratings

Parameters	50WQ...	Units	Conditions
I _{F(AV)} Max. Average Forward Current * See Fig. 5	5.5	A	50% duty cycle @ T _C = 135°C, rectangular wave form
I _{FSM} Max. Peak One Cycle Non-Repetitive Surge Current * See Fig. 7 Following any rated load condition and with rated V _{RWM} applied	300	A	3μs Sine or 3μs Rect. pulse
	100		6ms Sine or 6ms Rect. pulse
	480		3μs Sine or 3μs Rect. pulse
	165		6ms Sine or 6ms Rect. pulse
E _{AS} Non-Repetitive Avalanche Energy	6.0	mJ	T _J = 25 °C, I _{AS} = 0.5 Amps, L = 40 mH
I _{AR} Repetitive Avalanche Current	0.5	A	Current decaying linearly to zero in 1 μsec Frequency limited by T _J max. V _A = 1.5 x V _R typical

Electrical Specifications

Parameters	50WQ...	Units	Conditions
V _{FM} Max. Forward Voltage Drop * See Fig. 1 (1)	0.77	V	@ 5A
	0.91	V	@ 10A
	0.63	V	@ 5A
	0.74	V	@ 10A
I _{RM} Max. Reverse Leakage Current * See Fig. 2 (1)	0.22	mA	T _J = 25 °C
	4	mA	T _J = 125 °C
V _{F(TO)} Threshold Voltage	0.47	V	T _J = T _J max.
r _t Forward Slope Resistance	21.46	mΩ	
C _T Typical Junction Capacitance	183	pF	V _R = 5V _{DC} (test signal range 100Khz to 1Mhz) 25 °C
L _S Typical Series Inductance	5.0	nH	Measured lead to lead 5mm from package body

(1) Pulse Width < 300μs, Duty Cycle < 2%

Thermal-Mechanical Specifications

Parameters	50WQ...	Units	Conditions
T _J Max. Junction Temperature Range (*)	-40 to 150	°C	
T _{stg} Max. Storage Temperature Range	-40 to 150	°C	
R _{thJC} Max. Thermal Resistance Junction to Case	3.0	°C/W	DC operation *See Fig. 4
wt Approximate Weight	0.3(0.01)	g(oz.)	
Case Style	D-Pak		Similar to TO-252AA
Device Marking	50WQ10G		

(*) $\frac{dP_{tot}}{dT_J} < \frac{1}{R_{th(j-a)}}$ thermal runaway condition for a diode on its own heatsink

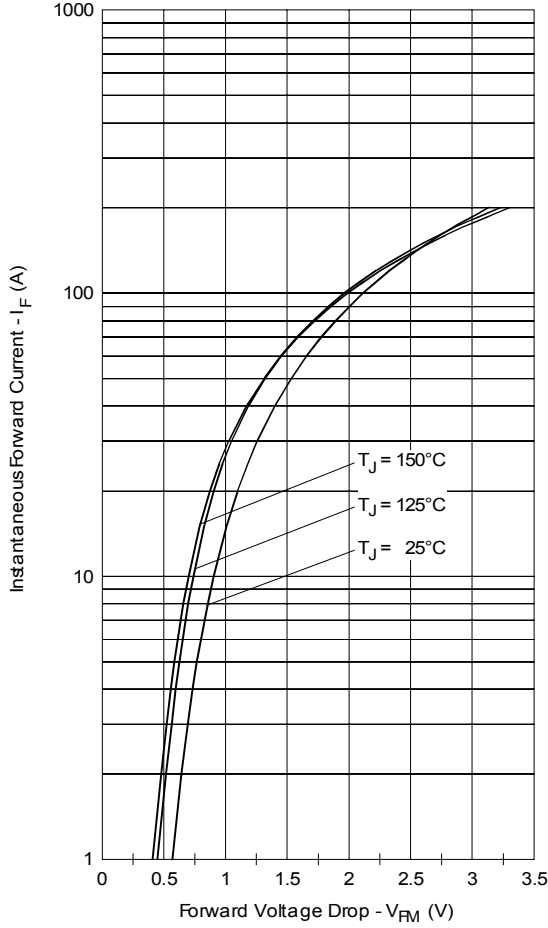

Fig. 1 - Maximum Forward Voltage Drop Characteristics

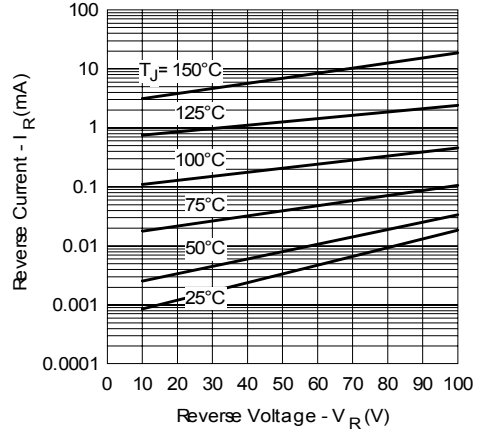

Fig. 2 - Typical Values of Reverse Current Vs. Reverse Voltage

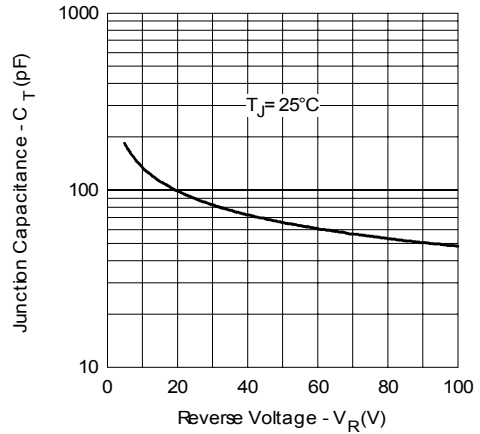

Fig. 3 - Typical Junction Capacitance Vs. Reverse Voltage

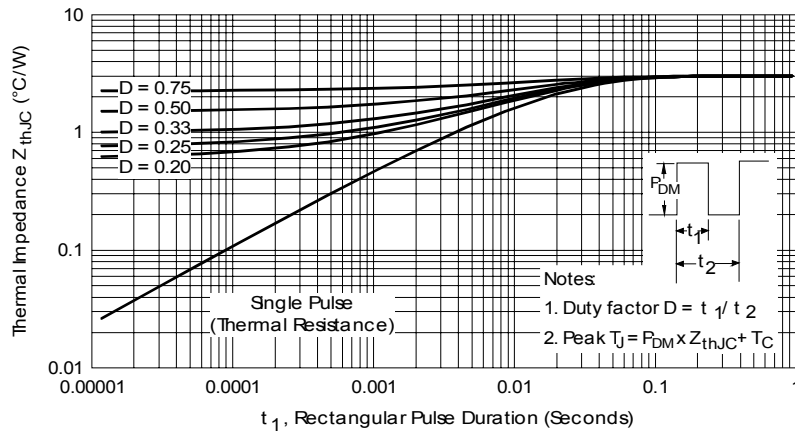

Fig. 4 - Maximum Thermal Impedance Z_{thJC} Characteristics

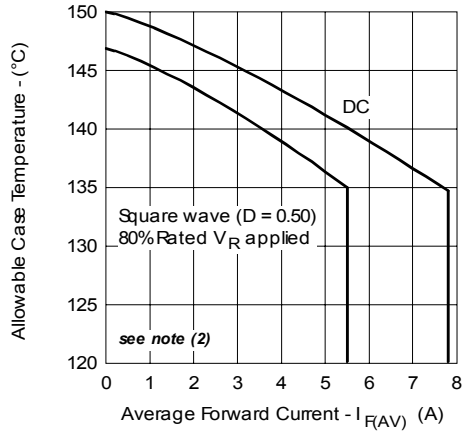

Fig. 5 - Maximum Allowable Case Temperature Vs. Average Forward Current

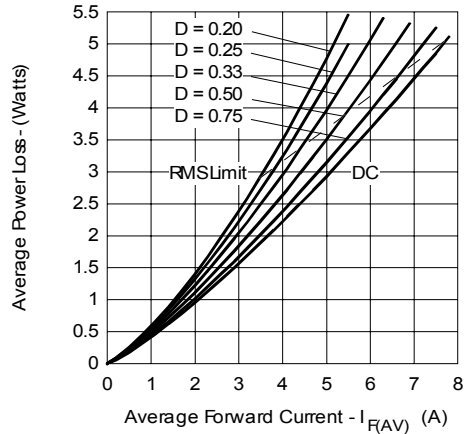

Fig. 6 - Forward Power Loss Characteristics

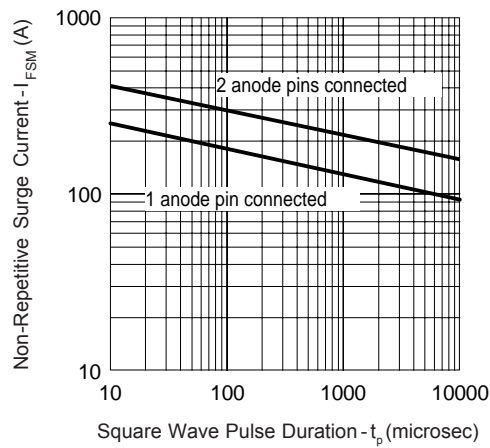

Fig. 7 - Maximum Non-Repetitive Surge Current

(2) Formula used: $T_C = T_J - (Pd + Pd_{REV}) \times R_{thJC}$;

$Pd = \text{Forward Power Loss} = I_{F(AV)} \times V_{FM} @ (I_{F(AV)} / D)$ (see Fig. 6);

$Pd_{REV} = \text{Inverse Power Loss} = V_{R1} \times I_R (1 - D)$; $I_R @ V_{R1} = 80\% \text{ rated } V_R$

Outline Table

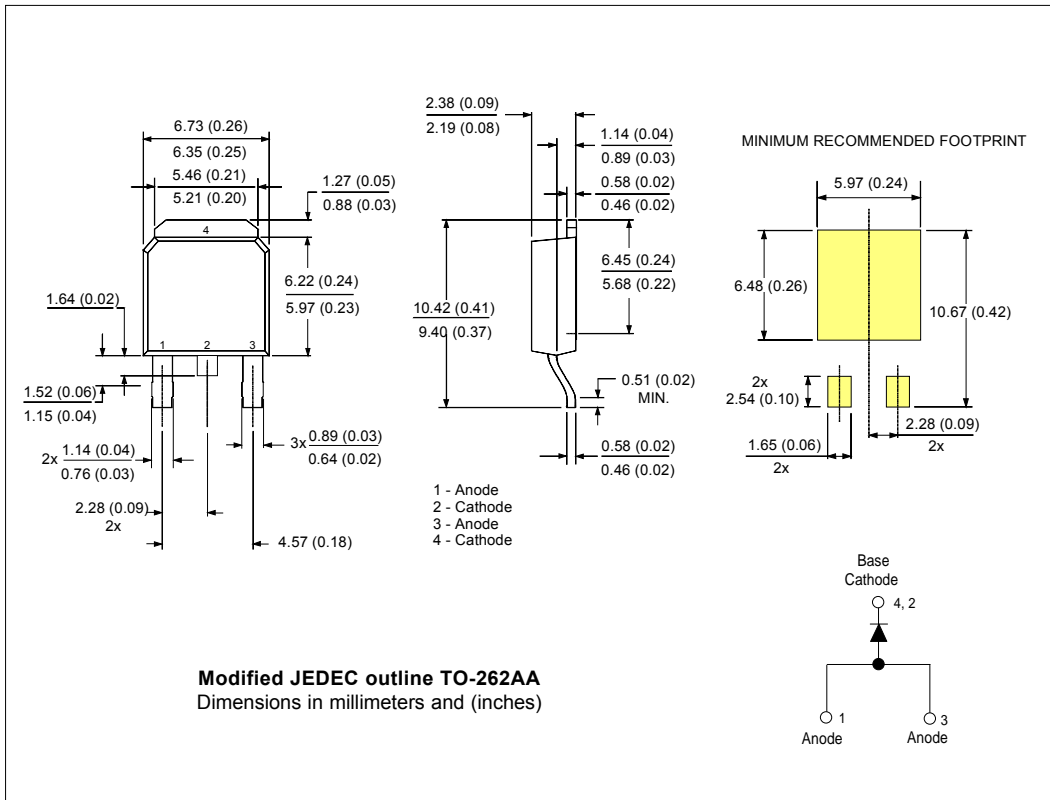

Marking Information

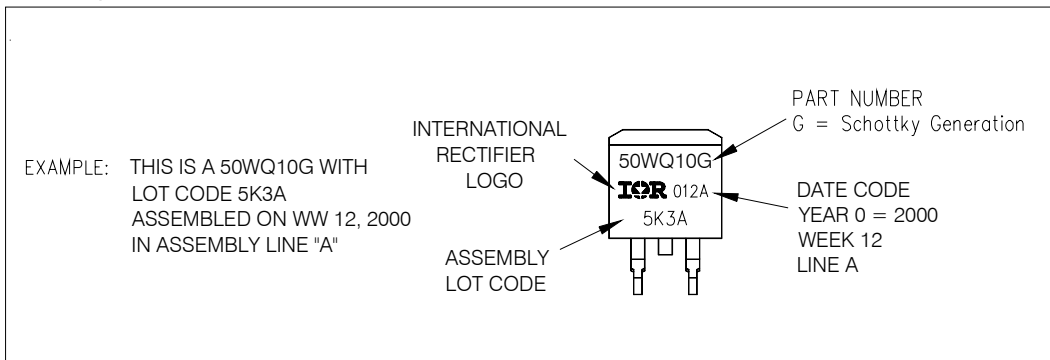

Tape & Reel Information

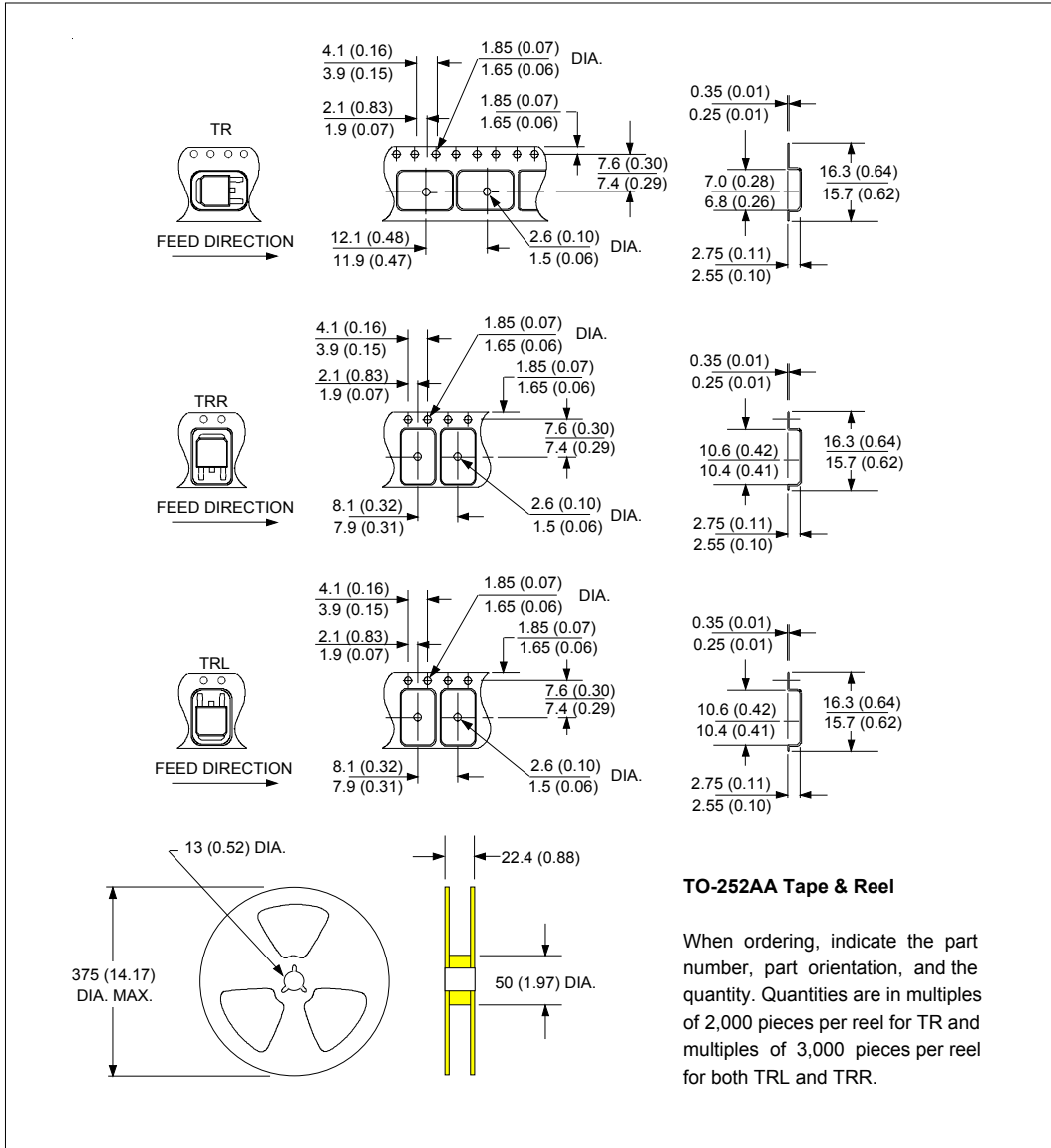

Ordering Information Table

Device Code															
	<table border="1" style="margin: auto;"> <tr> <td style="padding: 5px;">50</td> <td style="padding: 5px;">W</td> <td style="padding: 5px;">Q</td> <td style="padding: 5px;">10</td> <td style="padding: 5px;">G</td> <td style="padding: 5px;">TRL</td> <td style="padding: 5px;">-</td> </tr> <tr> <td style="text-align: center;">①</td> <td style="text-align: center;">②</td> <td style="text-align: center;">③</td> <td style="text-align: center;">④</td> <td style="text-align: center;">⑤</td> <td style="text-align: center;">⑥</td> <td style="text-align: center;">⑦</td> </tr> </table>	50	W	Q	10	G	TRL	-	①	②	③	④	⑤	⑥	⑦
50	W	Q	10	G	TRL	-									
①	②	③	④	⑤	⑥	⑦									
1	- Current Rating (5.5A)														
2	- Package W = D-PAK Q = Schottky Q Series														
3	- Voltage Rating: Code x 10 = V_{RRM} (10 = 100V)														
4	- Schottky Generation														
5	- • None = Tube (75 pieces)														
6	- • TR = Tape & Reel • TRL = Tape & Reel (Left Oriented) • TRR = Tape & Reel (Right Oriented)														
7	- • none = Standard Production • PbF = Lead-Free														

Data and specifications subject to change without notice.
 This product has been designed for Q101.
 Qualification Standards can be found on IR's Web site.