

## 54ABT373

### Octal Transparent Latch with TRI-STATE® Outputs

#### General Description

The 'ABT373 consists of eight latches with TRI-STATE outputs for bus organized system applications. The flip-flops appear transparent to the data when Latch Enable (LE) is HIGH. When LE is LOW, the data that meets the setup times is latched. Data appears on the bus when the Output Enable ( $\overline{OE}$ ) is LOW. When  $\overline{OE}$  is HIGH the bus output is in the high impedance state.

#### Features

- TRI-STATE outputs for bus interfacing
- Output sink capability of 48 mA, source capability of 24 mA

- Guaranteed multiple output switching specifications
- Output switching specified for both 50 pF and 250 pF loads
- Guaranteed simultaneous switching, noise level and dynamic threshold performance
- Guaranteed latching protection
- High impedance glitch free bus loading during entire power up and power down
- Nondestructive hot insertion capability
- Standard Microcircuit Drawing (SMD) 5962-9321801

#### Ordering Code

Military	Package Number	Package Description
54ABT373J-QML	J20A	20-Lead Ceramic Dual-In-Line
54ABT373W-QML	W20A	20-Lead Cerpack
54ABT373E-QML	E20A	20-Lead Ceramic Leadless Chip Carrier, Type C

#### Connection Diagrams

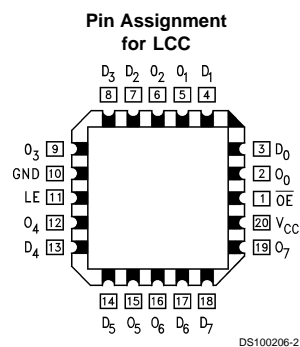
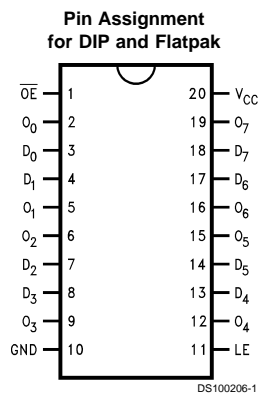

Pin Names	Description
$D_0$ – $D_7$	Data Inputs
LE	Latch Enable Input (Active HIGH)
$\overline{OE}$	Output Enable Input (Active LOW)
$O_0$ – $O_7$	TRI-STATE Latch Outputs

TRI-STATE® is a registered trademark of National Semiconductor Corporation.

## Functional Description

The 'ABT373 contains eight D-type latches with TRI-STATE output buffers. When the Latch Enable (LE) input is HIGH, data on the  $D_n$  inputs enters the latches. In this condition the latches are transparent, i.e., a latch output will change state each time its D input changes. When LE is LOW, the latches store the information that was present on the D inputs a setup time preceding the HIGH-to-LOW transition of LE. The TRI-STATE buffers are controlled by the Output Enable ( $\overline{OE}$ ) input. When  $\overline{OE}$  is LOW, the buffers are in the bi-state mode. When  $\overline{OE}$  is HIGH the buffers are in the high impedance mode but this does not interfere with entering new data into the latches.

## Truth Table

Inputs			Output
LE	$\overline{OE}$	$D_n$	$O_n$
H	L	H	H
H	L	L	L
L	L	X	$O_n$ (no change)
X	H	X	Z

H = HIGH Voltage Level  
 L = LOW Voltage Level  
 X = Immaterial  
 Z = High Impedance State

## Logic Diagram

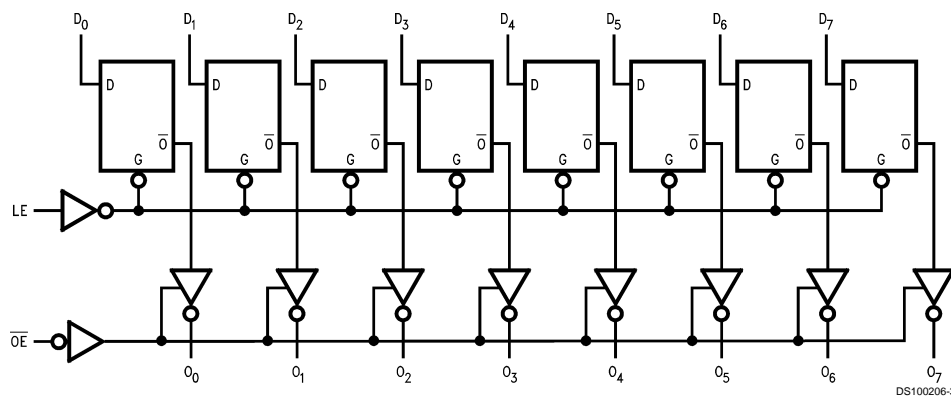

Please note that this diagram is provided only for the understanding of logic operations and should not be used to estimate propagation delays.

## Absolute Maximum Ratings (Note 1)

If Military/Aerospace specified devices are required, please contact the National Semiconductor Sales Office/Distributors for availability and specifications.

Storage Temperature	-65°C to +150°C
Ambient Temperature under Bias	-55°C to +125°C
Junction Temperature under Bias Ceramic	-55°C to +175°C
V <sub>CC</sub> Pin Potential to Ground Pin	-0.5V to +7.0V
Input Voltage (Note 2)	-0.5V to +7.0V
Input Current (Note 2)	-30 mA to +5.0 mA
Voltage Applied to Any Output in the Disabled or Power-Off State	-0.5V to +5.5V
in the HIGH State	-0.5V to V <sub>CC</sub>
Current Applied to Output in LOW State (Max)	twice the rated I <sub>OL</sub> (mA)

Over Voltage Latchup (I/O)

10V

## Recommended Operating Conditions

Free Air Ambient Temperature Military	-55°C to +125°C
Supply Voltage Military	+4.5V to +5.5V
Minimum Input Edge Rate (ΔV/Δt)	
Data Input	50 mV/ns
Enable Input	20 mV/ns

**Note 1:** Absolute maximum ratings are values beyond which the device may be damaged or have its useful life impaired. Functional operation under these conditions is not implied.

**Note 2:** Either voltage limit or current limit is sufficient to protect inputs.

## DC Electrical Characteristics

Symbol	Parameter	ABT373			Units	V <sub>CC</sub>	Conditions
		Min	Typ	Max			
V <sub>IH</sub>	Input HIGH Voltage	2.0			V		Recognized HIGH Signal
V <sub>IL</sub>	Input LOW Voltage			0.8	V		Recognized LOW Signal
V <sub>CD</sub>	Input Clamp Diode Voltage			-1.2	V	Min	I <sub>IN</sub> = -18 mA
V <sub>OH</sub>	Output HIGH Voltage	54ABT 2.5			V	Min	I <sub>OH</sub> = -3 mA I <sub>OH</sub> = -24 mA
V <sub>OL</sub>	Output LOW Voltage	54ABT 2.0			V	Min	I <sub>OL</sub> = 48 mA
I <sub>IH</sub>	Input HIGH Current			5	μA	Max	V <sub>IN</sub> = 2.7V (Note 4) V <sub>IN</sub> = V <sub>CC</sub>
I <sub>BVI</sub>	Input HIGH Current Breakdown Test			7	μA	Max	V <sub>IN</sub> = 7.0V
I <sub>IL</sub>	Input LOW Current			-5	μA	Max	V <sub>IN</sub> = 0.5V (Note 4) V <sub>IN</sub> = 0.0V
V <sub>ID</sub>	Input Leakage Test	4.75			V	0.0	I <sub>ID</sub> = 1.9 μA All Other Pins Grounded
I <sub>OZH</sub>	Output Leakage Current			50	μA	0 - 5.5V	V <sub>OUT</sub> = 2.7V; $\overline{OE}$ = 2.0V
I <sub>OZL</sub>	Output Leakage Current			-50	μA	0 - 5.5V	V <sub>OUT</sub> = 0.5V; $\overline{OE}$ = 2.0V
I <sub>OS</sub>	Output Short-Circuit Current	-100		-275	mA	Max	V <sub>OUT</sub> = 0.0V
I <sub>CEX</sub>	Output High Leakage Current			50	μA	Max	V <sub>OUT</sub> = V <sub>CC</sub>
I <sub>ZZ</sub>	Bus Drainage Test			100	μA	0.0	V <sub>OUT</sub> = 5.5V; All Others GND
I <sub>CCH</sub>	Power Supply Current			50	μA	Max	All Outputs HIGH
I <sub>CCL</sub>	Power Supply Current			30	mA	Max	All Outputs LOW
I <sub>CCZ</sub>	Power Supply Current			50	μA	Max	$\overline{OE}$ = V <sub>CC</sub> All Others at V <sub>CC</sub> or GND
I <sub>CC1</sub>	Additional I <sub>CC</sub> /Input	Outputs Enabled		2.5	mA		V <sub>I</sub> = V <sub>CC</sub> - 2.1V
		Outputs TRI-STATE		2.5	mA	Max	Enable Input V <sub>I</sub> = V <sub>CC</sub> - 2.1V
		Outputs TRI-STATE		2.5	mA		Data Input V <sub>I</sub> = V <sub>CC</sub> - 2.1V All Others at V <sub>CC</sub> or GND
I <sub>CCD</sub>	Dynamic I <sub>CC</sub> (Note 4)	No Load		0.12	mA/ MHz	Max	Outputs Open, LE = V <sub>CC</sub> $\overline{OE}$ = GND, (Note 3) One Bit Toggling, 50% Duty Cycle

**Note 3:** For 8 bits toggling, I<sub>CCD</sub> < 0.8 mA/MHz.

**Note 4:** Guaranteed, but not tested.

## AC Electrical Characteristics

Symbol	Parameter	54ABT		Units
		$T_A = -55^\circ\text{C to } +125^\circ\text{C}$ $V_{CC} = 4.5\text{V to } 5.5\text{V}$ $C_L = 50\text{ pF}$		
		Min	Max	
$t_{PLH}$	Propagation Delay	1.0	6.8	ns
$t_{PHL}$	$D_n$ to $O_n$	1.0	7.0	
$t_{PLH}$	Propagation Delay	1.0	7.7	ns
$t_{PHL}$	LE to $O_n$	1.5	7.7	
$t_{PZH}$	Output Enable Time	1.0	6.7	ns
$t_{PZL}$		1.5	7.2	
$t_{PHZ}$	Output Disable Time	1.7	8.0	ns
$t_{PLZ}$		1.0	7.0	

## AC Operating Requirements

Symbol	Parameter	54ABT		Units
		$T_A = -55^\circ\text{C to } +125^\circ\text{C}$ $V_{CC} = 4.5\text{V to } 5.5\text{V}$ $C_L = 50\text{ pF}$		
		Min	Max	
$t_s(H)$	Setup Time, HIGH	2.5		ns
$t_s(L)$	or LOW $D_n$ to LE	2.5		
$t_h(H)$	Hold Time, HIGH	2.5		ns
$t_h(L)$	or LOW $D_n$ to LE	2.5		
$t_w(H)$	Pulse Width, LE HIGH	3.3		ns

## Capacitance

Symbol	Parameter	Typ	Units	Conditions ( $T_A = 25^\circ\text{C}$ )
$C_{IN}$	Input Capacitance	5	pF	$V_{CC} = 0\text{V}$
$C_{OUT}$ (Note 5)	Output Capacitance	9	pF	$V_{CC} = 5.0\text{V}$

Note 5:  $C_{OUT}$  is measured at frequency  $f = 1\text{ MHz}$ , per MIL-STD-883B, Method 3012.

$t_{PLH}$  vs Temperature ( $T_A$ )  
 $C_L = 50\text{ pF}$ , 1 Output Switching  
 Data to Output

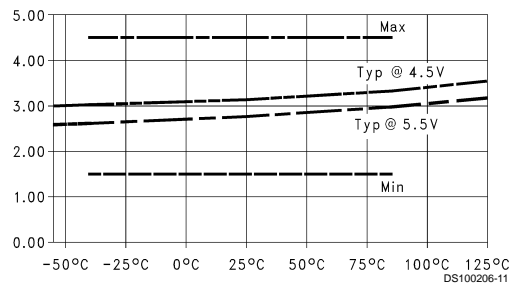

$t_{PHL}$  vs Temperature ( $T_A$ )  
 $C_L = 50\text{ pF}$ , 1 Output Switching  
 Data to Output

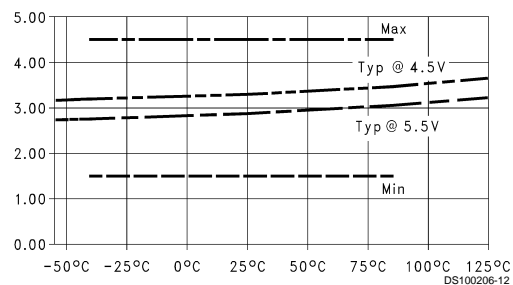

Dashed lines represent design characteristics; for specified guarantees, refer to AC Characteristics Tables.

## Capacitance (Continued)

**$t_{PZH}$  vs Temperature ( $T_A$ )**  
 $C_L = 50 \text{ pF}$ , 1 Output Switching  
 OE to Output

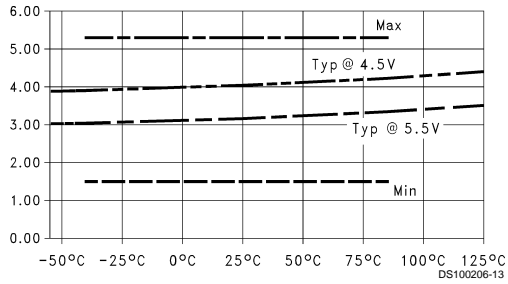

**$t_{PZL}$  vs Temperature ( $T_A$ )**  
 $C_L = 50 \text{ pF}$ , 1 Output Switching  
 OE to Output

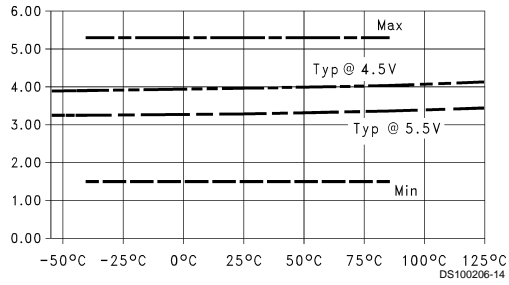

**$t_{PHZ}$  vs Temperature ( $T_A$ )**  
 $C_L = 50 \text{ pF}$ , 1 Output Switching  
 OE to Output

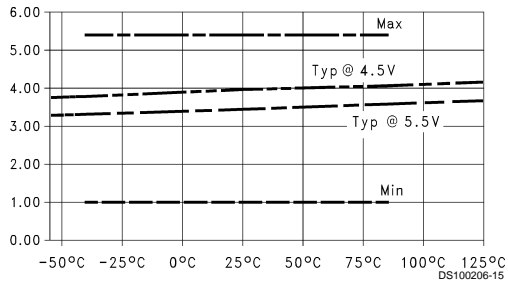

**$t_{PLZ}$  vs Temperature ( $T_A$ )**  
 $C_L = 50 \text{ pF}$ , 1 Output Switching  
 OE to Output

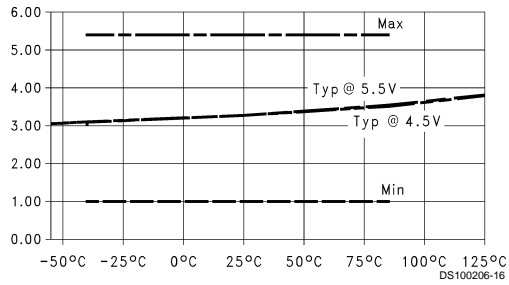

**$t_{SET \text{ LOW}}$  vs Temperature ( $T_A$ )**  
 $C_L = 50 \text{ pF}$ , 1 Output Switching  
 Data to LE

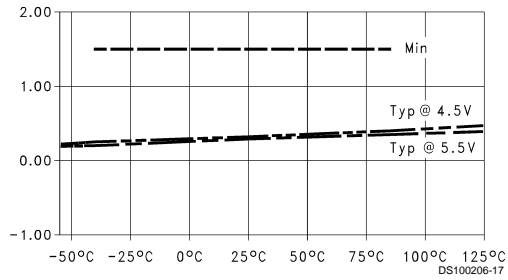

**$t_{SET \text{ HIGH}}$  vs Temperature ( $T_A$ )**  
 $C_L = 50 \text{ pF}$ , 1 Output Switching  
 Data to LE

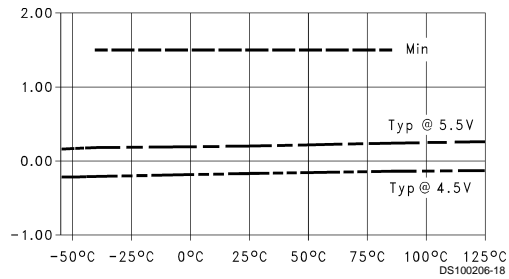

Dashed lines represent design characteristics; for specified guarantees, refer to AC Characteristics Tables.

## Capacitance (Continued)

**$t_{\text{HOLD HIGH}}$  vs Temperature ( $T_A$ )**  
 $C_L = 50 \text{ pF}$ , 1 Output Switching  
 Data to LE

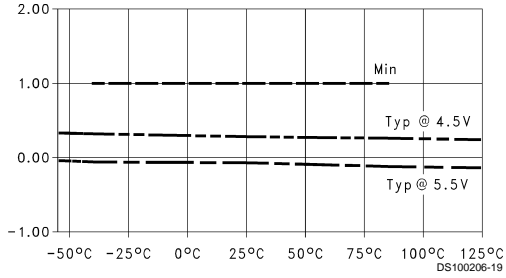

**$t_{\text{HOLD LOW}}$  vs Temperature ( $T_A$ )**  
 $C_L = 50 \text{ pF}$ , 1 Output Switching  
 Data to LE

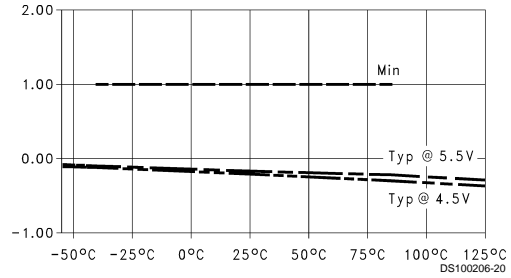

**$t_{\text{PLH}}$  vs Temperature ( $T_A$ )**  
 $C_L = 50 \text{ pF}$ , 8 Outputs Switching  
 Data to Output

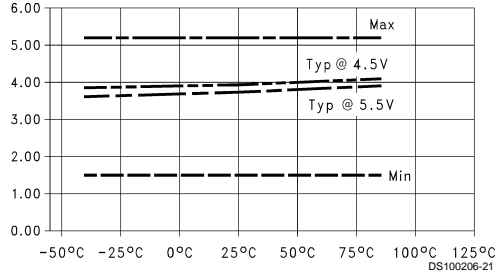

**$t_{\text{PHL}}$  vs Temperature ( $T_A$ )**  
 $C_L = 50 \text{ pF}$ , 8 Outputs Switching  
 Data to Output

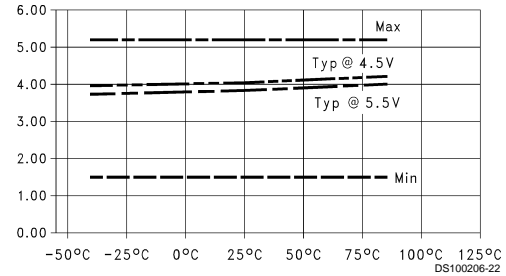

**$t_{\text{PZH}}$  vs Temperature ( $T_A$ )**  
 $C_L = 50 \text{ pF}$ , 8 Outputs Switching  
 OE to Output

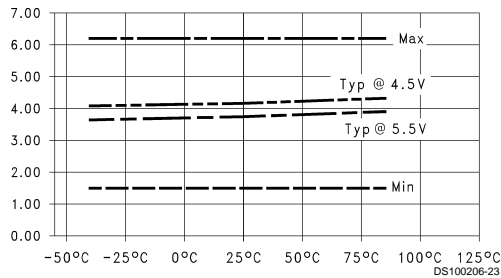

**$t_{\text{PZL}}$  vs Temperature ( $T_A$ )**  
 $C_L = 50 \text{ pF}$ , 8 Outputs Switching  
 OE to Output

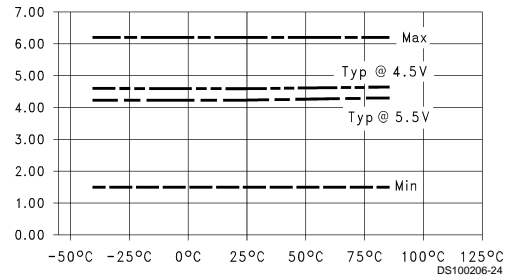

Dashed lines represent design characteristics; for specified guarantees, refer to AC Characteristics Tables.

## Capacitance (Continued)

**$t_{PHZ}$  vs Temperature ( $T_A$ )**  
 $C_L = 50 \text{ pF}$ , 8 Outputs Switching  
 OE to Output

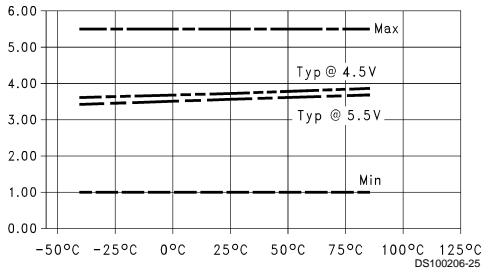

**$t_{PLZ}$  vs Temperature ( $T_A$ )**  
 $C_L = 50 \text{ pF}$ , 8 Outputs Switching  
 OE to Output

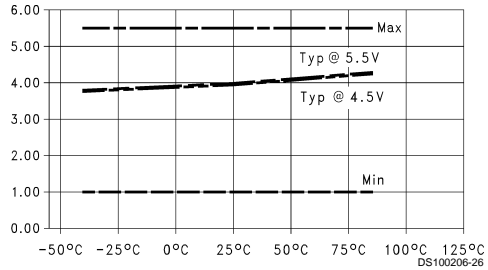

**$t_{PLH}$  vs Load Capacitance**  
 $T_A = 25^\circ\text{C}$ , 1 Output Switching  
 Data to Output

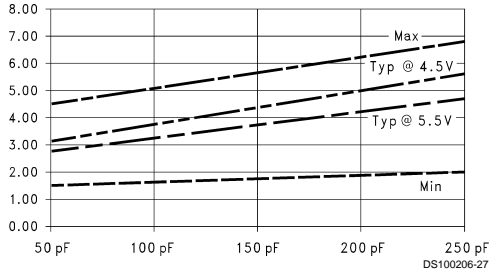

**$t_{PLH}$  vs Load Capacitance**  
 $T_A = 25^\circ\text{C}$ , 1 Output Switching  
 Data to Output

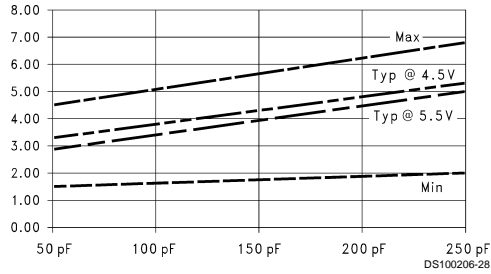

**$t_{PLH}$  vs Load Capacitance**  
 $T_A = 25^\circ\text{C}$ , 8 Outputs Switching  
 Data to Output

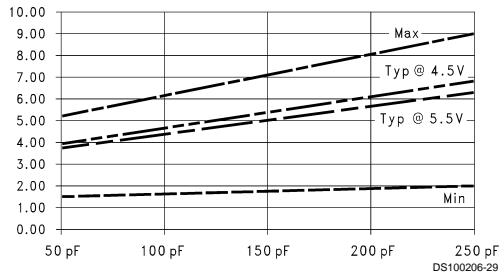

**$t_{PLH}$  vs Load Capacitance**  
 $T_A = 25^\circ\text{C}$ , 8 Outputs Switching  
 Data to Output

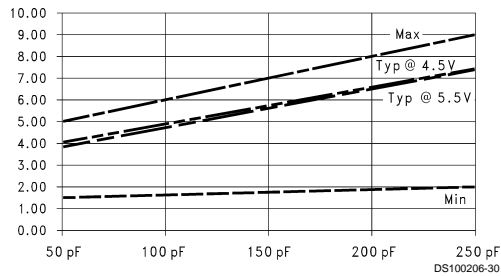

Dashed lines represent design characteristics; for specified guarantees, refer to AC Characteristics Tables.

## Capacitance (Continued)

**$t_{PZH}$  vs Load Capacitance**  
 $T_A = 25^\circ\text{C}$ , 8 Outputs Switching  
 OE to Output

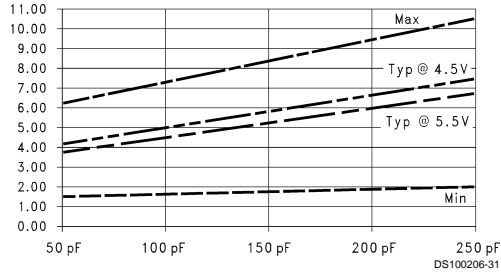

**$t_{PZL}$  vs Load Capacitance**  
 $T_A = 25^\circ\text{C}$ , 8 Outputs Switching  
 OE to Output

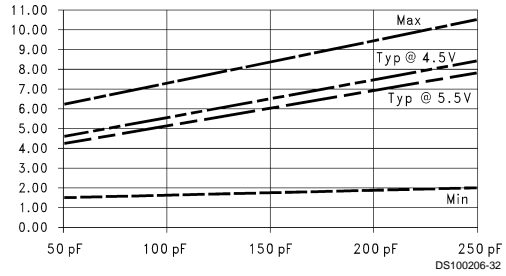

**$t_{PLH}$  vs Temperature ( $T_A$ )**  
 $C_L = 50$  pF, 1 Output Switching  
 LE to Output

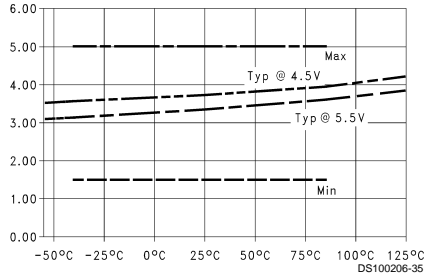

**$t_{PHL}$  vs Temperature ( $T_A$ )**  
 $C_L = 50$  pF, 1 Output Switching  
 LE to Output

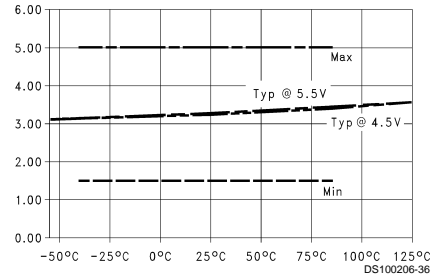

**$t_{PLH}$  vs Temperature ( $T_A$ )**  
 $C_L = 50$  pF, 8 Outputs Switching  
 LE to Output

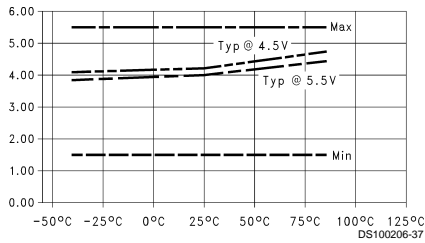

**$t_{PHL}$  vs Temperature ( $T_A$ )**  
 $C_L = 50$  pF, 8 Outputs Switching  
 LE to Output

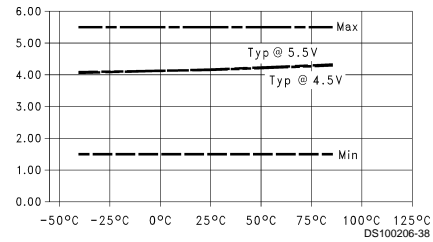

Dashed lines represent design characteristics; for specified guarantees, refer to AC Characteristics Tables.



## Capacitance (Continued)

**$t_{PLH}$  and  $t_{PHL}$  vs Number Outputs Switching**  
 $C_L = 50 \text{ pF}$ ,  $T_A = 25^\circ\text{C}$ ,  $V_{CC} = 5.0\text{V}$ ,  
 Outputs In Phase Data to Output

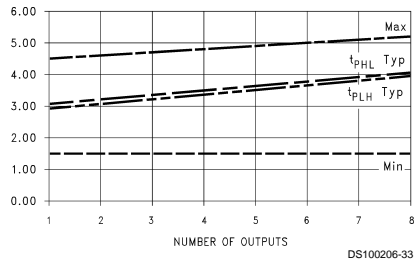

**Typical  $I_{CC}$  vs Output Switching Frequency**  
 $C_L = 0 \text{ pF}$ ,  $V_{CC} = V_{IH} = 5.5\text{V}$ ,  $LE = \text{GND}$ ,  
 1 Output Switching at 50% Duty Cycle  
 Data to Output, Transparent Mode with  
 Unused Data Inputs =  $V_{IH}$

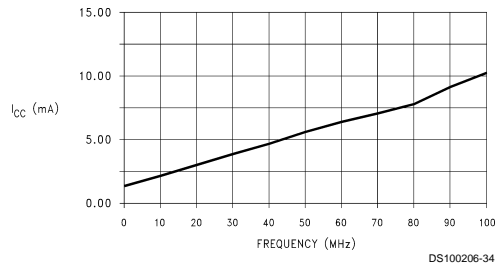

Dashed lines represent design characteristics; for specified guarantees, refer to AC Characteristics Tables.

## AC Loading

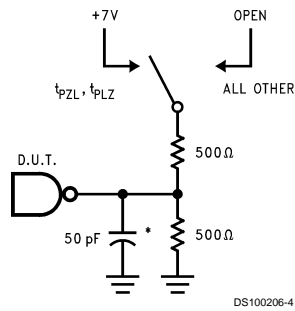

\*Includes jig and probe capacitance

FIGURE 1. Standard AC Test Load

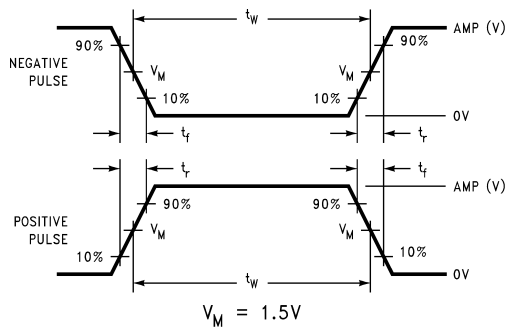

FIGURE 2. Test Input Signal Levels

Amplitude	Rep. Rate	$t_w$	$t_r$	$t_f$
3.0V	1 MHz	500 ns	2.5 ns	2.5 ns

FIGURE 3. Test Input Signal Requirements

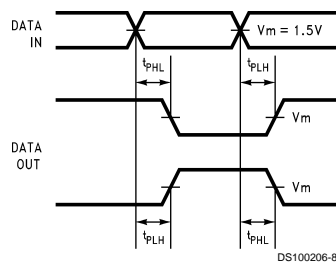

FIGURE 4. Propagation Delay Waveforms for Inverting and Non-Inverting Functions

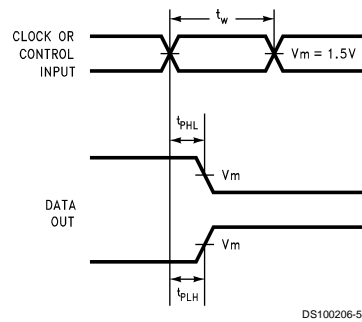

FIGURE 5. Propagation Delay, Pulse Width Waveforms

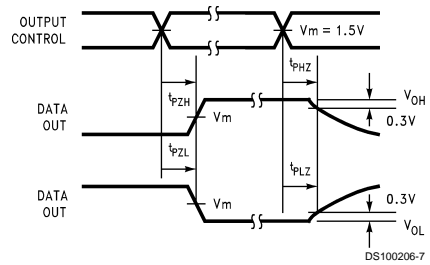

FIGURE 6. TRI-STATE Output HIGH and LOW Enable and Disable Times

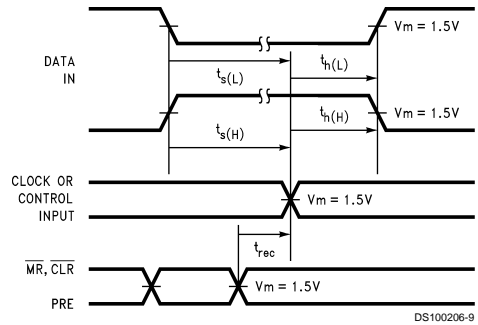
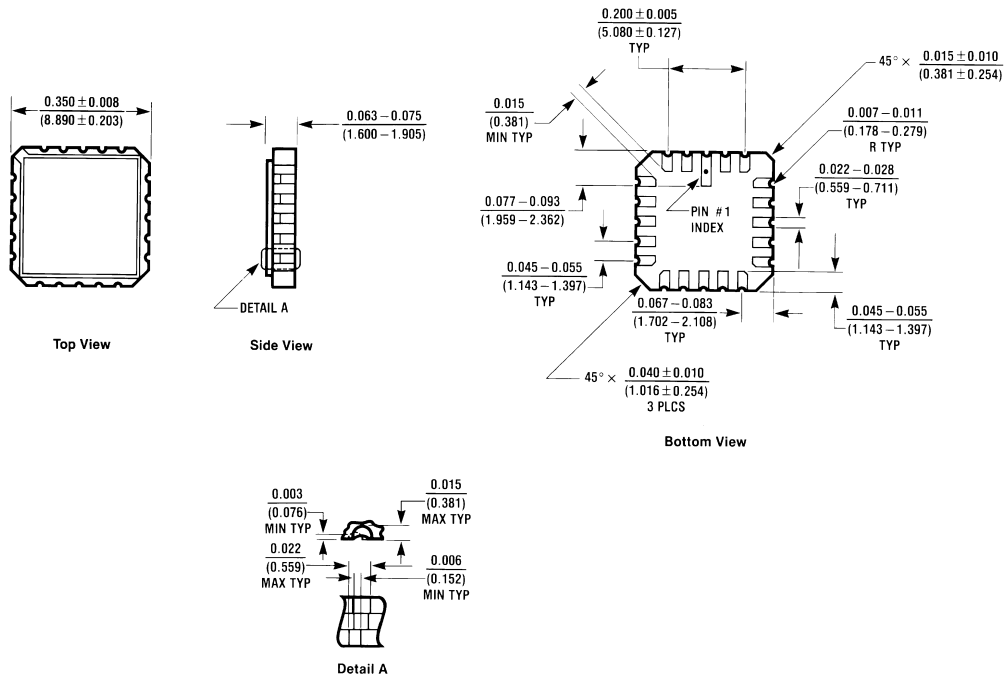

FIGURE 7. Setup Time, Hold Time and Recovery Time Waveforms



**Physical Dimensions** inches (millimeters) unless otherwise noted



E20A (REV D)

**20-Terminal Ceramic Chip Carrier (L)**  
**NS Package Number E20A**

**Physical Dimensions** inches (millimeters) unless otherwise noted (Continued)

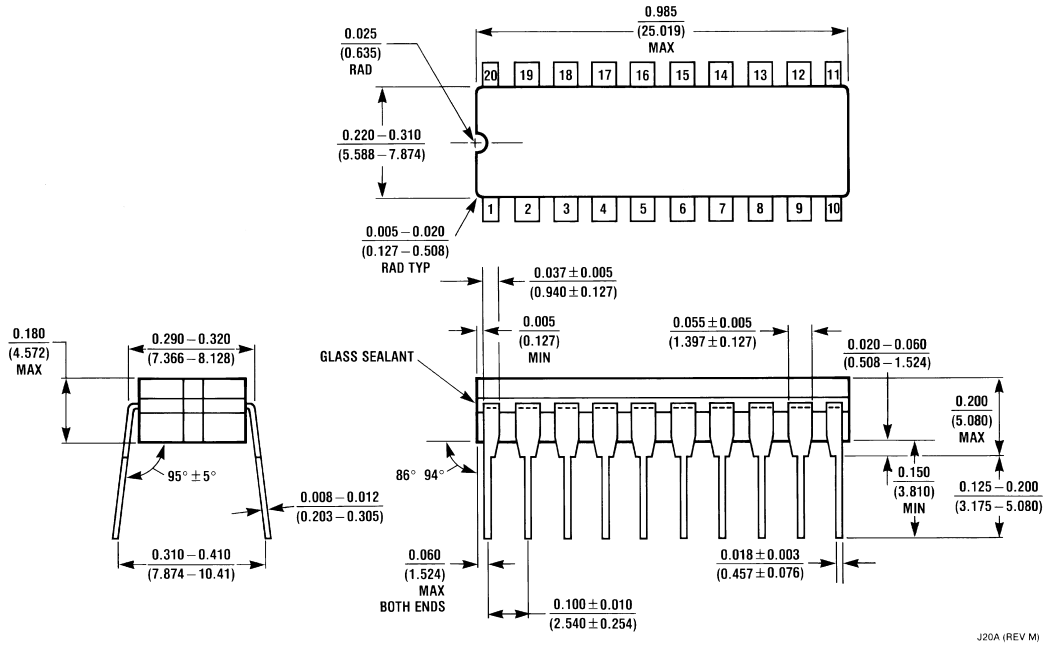

**20-Lead Ceramic Dual-In-Line (D)**  
NS Package Number J20A

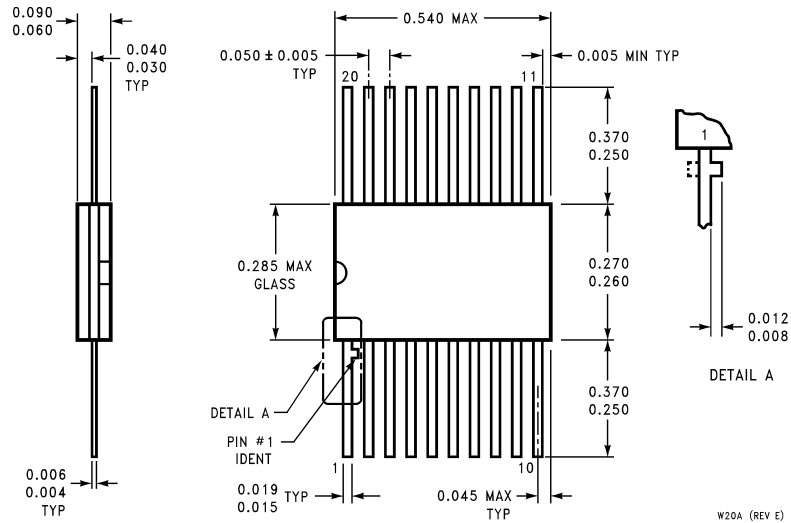

**20-Lead Ceramic Flatpak (F)**  
NS Package Number W20A

**LIFE SUPPORT POLICY**

NATIONAL'S PRODUCTS ARE NOT AUTHORIZED FOR USE AS CRITICAL COMPONENTS IN LIFE SUPPORT DEVICES OR SYSTEMS WITHOUT THE EXPRESS WRITTEN APPROVAL OF THE PRESIDENT OF NATIONAL SEMICONDUCTOR CORPORATION. As used herein:

1. Life support devices or systems are devices or systems which, (a) are intended for surgical implant into the body, or (b) support or sustain life, and whose failure to perform when properly used in accordance with instructions for use provided in the labeling, can be reasonably expected to result in a significant injury to the user.
2. A critical component in any component of a life support device or system whose failure to perform can be reasonably expected to cause the failure of the life support device or system, or to affect its safety or effectiveness.



**National Semiconductor Corporation**  
Americas  
Tel: 1-800-272-9959  
Fax: 1-800-737-7018  
Email: support@nsc.com

[www.national.com](http://www.national.com)

**National Semiconductor Europe**  
Fax: +49 (0) 1 80-530 85 86  
Email: europe.support@nsc.com  
Deutsch Tel: +49 (0) 1 80-530 85 85  
English Tel: +49 (0) 1 80-532 78 32  
Français Tel: +49 (0) 1 80-532 93 58  
Italiano Tel: +49 (0) 1 80-534 16 80

**National Semiconductor Asia Pacific Customer Response Group**  
Tel: 65-2544466  
Fax: 65-2504466  
Email: sea.support@nsc.com

**National Semiconductor Japan Ltd.**  
Tel: 81-3-5620-6175  
Fax: 81-3-5620-6179