

# CEP6060R/CEB6060R

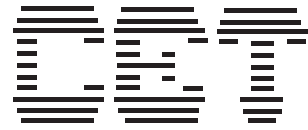

PRELIMINARY

4

## N-Channel Enhancement Mode Field Effect Transistor

### FEATURES

- 60V , 60A ,  $R_{DS(ON)}=25m\Omega$  @  $V_{GS}=10V$ .
- Super high dense cell design for extremely low  $R_{DS(ON)}$ .
- High power and current handling capability.
- TO-220 & TO-263 package.

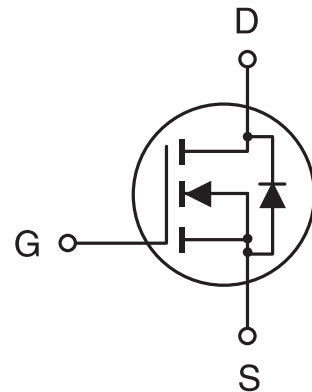

### ABSOLUTE MAXIMUM RATINGS ( $T_c=25^\circ\text{C}$ unless otherwise noted)

| Parameter   | Symbol         | Limit      | Unit                |
|---|----------------|------------|---------------------|
| Drain-Source Voltage  | $V_{DS}$       | 60         | V                   |
| Gate-Source Voltage   | $V_{GS}$       | $\pm 20$   | V                   |
| Drain Current-Continuous<br>-Pulsed   | $I_D$          | 60         | A                   |
|   | $I_{DM}$       | 144        | A                   |
| Drain-Source Diode Forward Current  | $I_S$          | 60         | A                   |
| Maximum Power Dissipation @ $T_c=25^\circ\text{C}$<br>Derate above $25^\circ\text{C}$ | $P_D$          | 100        | W                   |
|   |                | 0.7        | W/ $^\circ\text{C}$ |
| Operating and Storage Temperature Range   | $T_J, T_{STG}$ | -65 to 175 | $^\circ\text{C}$    |

### THERMAL CHARACTERISTICS

|   |                 |      |                    |
|---|-----------------|------|--------------------|
| Thermal Resistance, Junction-to-Case    | $R_{\theta JC}$ | 2    | $^\circ\text{C/W}$ |
| Thermal Resistance, Junction-to-Ambient | $R_{\theta JA}$ | 62.5 | $^\circ\text{C/W}$ |

# CEP6060R/CEB6060R

## ELECTRICAL CHARACTERISTICS (T<sub>c</sub>=25°C unless otherwise noted)

4

| Parameter  | Symbol              | Condition   | Min | Typ | Max  | Unit |
|--|---------------------|---|-----|-----|------|------|
| <b>DRAIN-SOURCE AVALANCHE RATING<sup>a</sup></b> |                     |   |     |     |      |      |
| Single Pulse Drain-Source Avalanche Energy       | E <sub>AS</sub>     | V <sub>DD</sub> =25V, I <sub>D</sub> =100A  |     | 200 |      | mJ   |
| Maximum Drain-Source Avalanche Current           | I <sub>AS</sub>     | L=25μH  |     | 100 |      | A    |
| <b>OFF CHARACTERISTICS</b>                       |                     |   |     |     |      |      |
| Drain-Source Breakdown Voltage                   | BV <sub>DSS</sub>   | V <sub>GS</sub> =0V, I <sub>D</sub> =250μA  | 60  |     |      | V    |
| Zero Gate Voltage Drain Current                  | I <sub>DSS</sub>    | V <sub>DS</sub> =60V, V <sub>GS</sub> =0V   |     |     | 25   | μA   |
| Gate-Body Leakage                                | I <sub>GSS</sub>    | V <sub>GS</sub> =±20V, V <sub>DS</sub> =0V  |     |     | ±100 | nA   |
| <b>ON CHARACTERISTICS<sup>a</sup></b>            |                     |   |     |     |      |      |
| Gate Threshold Voltage                           | V <sub>GS(th)</sub> | V <sub>DS</sub> =V <sub>GS</sub> , I <sub>D</sub> =250μA  | 2   | 2.8 | 4    | V    |
| Drain-Source On-State Resistance                 | R <sub>DS(ON)</sub> | V <sub>GS</sub> =10V, I <sub>D</sub> =24A   |     | 19  | 25   | mΩ   |
| On-State Drain Current                           | I <sub>D(ON)</sub>  | V <sub>GS</sub> =10V, V <sub>DS</sub> =10V  | 60  |     |      | A    |
| Forward Transconductance                         | g <sub>FS</sub>     | V <sub>DS</sub> =10V, I <sub>D</sub> =24A   |     | 20  |      | S    |
| <b>SWITCHING CHARACTERISTICS<sup>b</sup></b>     |                     |   |     |     |      |      |
| Turn-On Delay Time                               | t <sub>D(ON)</sub>  | V <sub>DD</sub> =30V,<br>I <sub>D</sub> =48A,<br>V <sub>GS</sub> =10V,<br>R <sub>GS</sub> =7.5Ω |     | 15  | 20   | ns   |
| Rise Time  | t <sub>r</sub>      |   |     | 250 | 300  | ns   |
| Turn-Off Delay Time                              | t <sub>D(OFF)</sub> |   |     | 45  | 60   | ns   |
| Fall Time  | t <sub>f</sub>      |   |     | 130 | 150  | ns   |
| Total Gate Charge                                | Q <sub>g</sub>      | V <sub>DS</sub> =48V, I <sub>D</sub> =48A,<br>V <sub>GS</sub> =10V                              |     | 64  | 70   | nC   |
| Gate-Source Charge                               | Q <sub>gs</sub>     |   |     | 8   |      | nC   |
| Gate-Drain Charge                                | Q <sub>gd</sub>     |   |     | 13  |      | nC   |

# CEP6060R/CEB6060R

4

## ELECTRICAL CHARACTERISTICS ( $T_c=25^\circ\text{C}$ unless otherwise noted)

| Parameter   | Symbol    | Condition  | Min | Typ  | Max  | Unit |
|---|-----------|--|-----|------|------|------|
| <b>DYNAMIC CHARACTERISTICS<sup>b</sup></b>            |           |  |     |      |      |      |
| Input Capacitance                                     | $C_{iss}$ | $V_{DS}=25\text{V}, V_{GS}=0\text{V}$<br>$f=1.0\text{MHz}$ |     | 1178 | 1600 | pF   |
| Output Capacitance                                    | $C_{oss}$ |  |     | 428  | 560  | pF   |
| Reverse Transfer Capacitance                          | $C_{rss}$ |  |     | 95   | 130  | pF   |
| <b>DRAIN-SOURCE DIODE CHARACTERISTICS<sup>b</sup></b> |           |  |     |      |      |      |
| Diode Forward Voltage                                 | $V_{SD}$  | $V_{GS}=0\text{V}, I_S=24\text{A}$                         |     | 0.9  | 1.3  | V    |

### Notes

- Pulse Test: Pulse Width  $\leq 300\ \mu\text{s}$ , Duty Cycle  $\leq 2\%$ .
- Guaranteed by design, not subject to production testing.

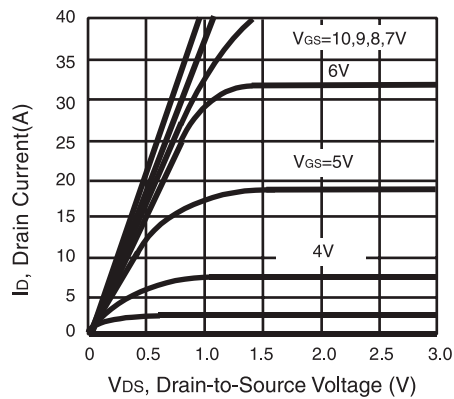

Figure 1. Output Characteristics

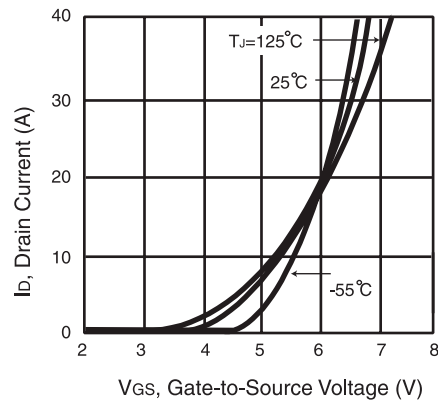

Figure 2. Transfer Characteristics

# CEP6060R/CEB6060R

4

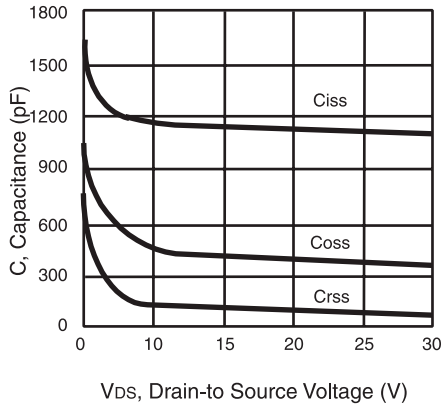

Figure 3. Capacitance

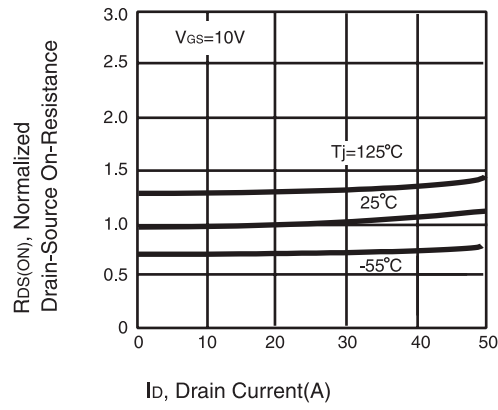

Figure 4. On-Resistance Variation with Drain Current and Temperature

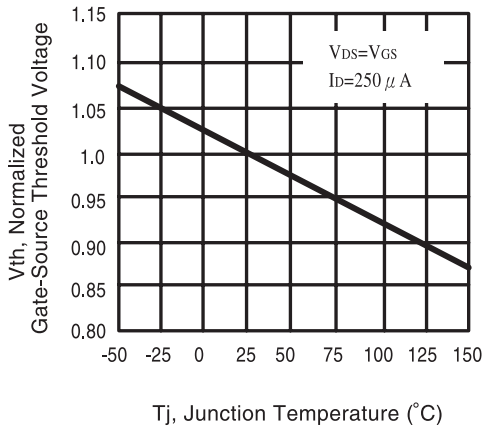

Figure 5. Gate Threshold Variation with Temperature

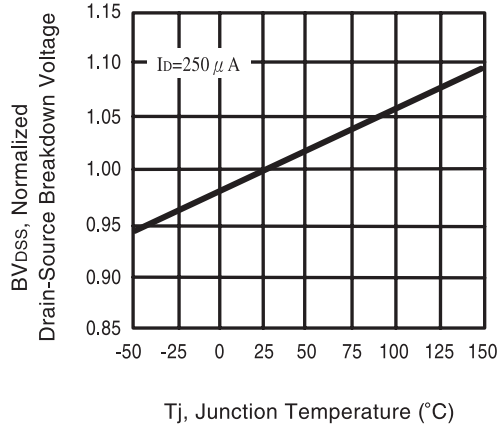

Figure 6. Breakdown Voltage Variation with Temperature

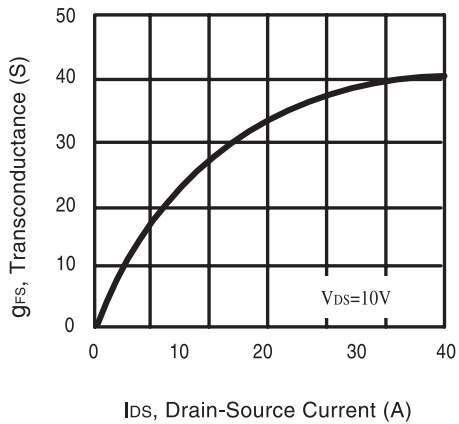

Figure 7. Transconductance Variation with Drain Current

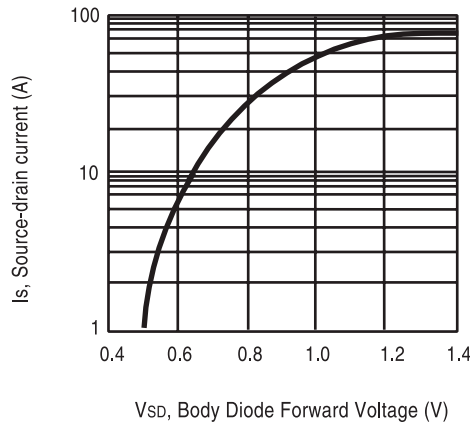

Figure 8. Body Diode Forward Voltage Variation with Source Current

# CEP6060R/CEB6060R

4

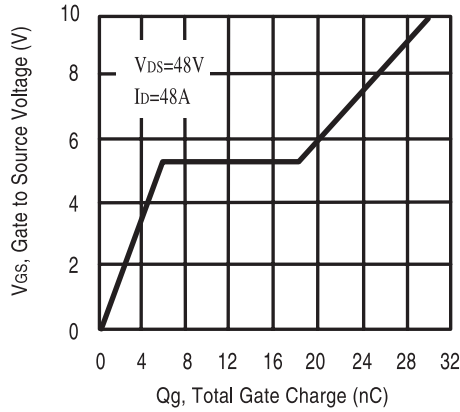

Figure 9. Gate Charge

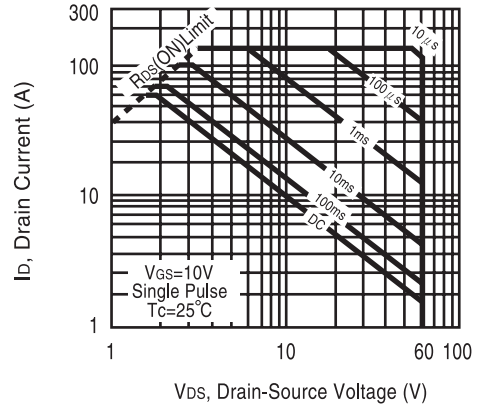

Figure 10. Maximum Safe Operating Area

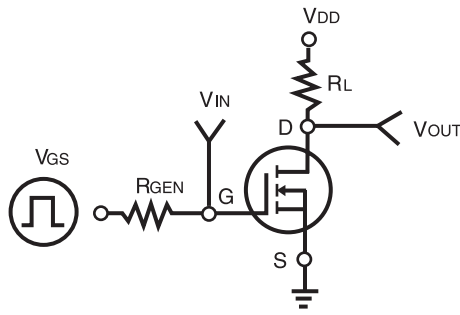

Figure 11. Switching Test Circuit

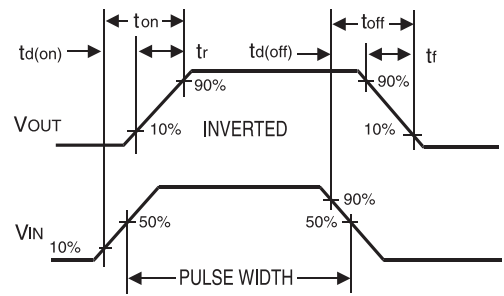

Figure 12. Switching Waveforms

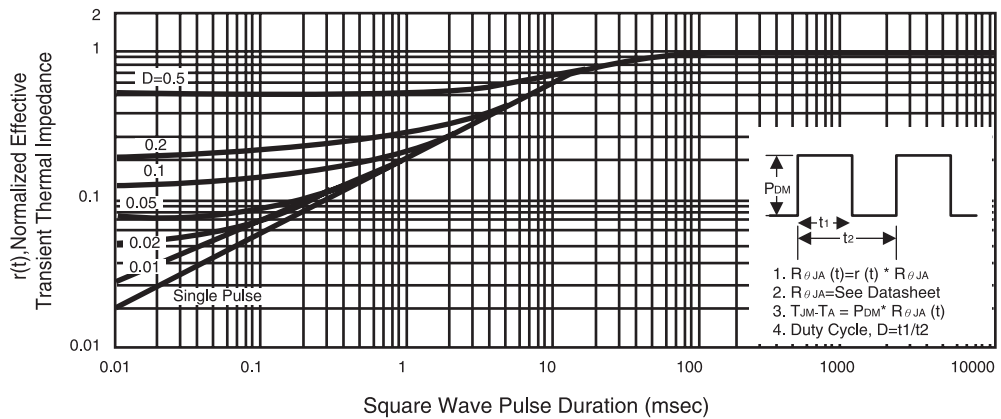

Figure 13. Normalized Thermal Transient Impedance Curve