

RECTIFIER ASSEMBLIES

Three Phase Bridges, 15-25 Amp, Standard and Fast Recovery Magnum®

678, 682, 695
696 SERIES

3

FEATURES

- Current Rating: to 25A
- PIVs: from 100 to 600V
- Only Fused-in-Glass Diodes Used
- Recovery Times: to 500ns
- Controlled Avalanche Characteristics
- Surge Ratings: to 150A
- Aluminum Heat Sink Case, Electrically Insulated

DESCRIPTION

This series of three phase MAGNUM® bridges offer the ultimate in high current power supply applications. The fast recovery series allows operation at full power at high frequencies (up to 40KHz squarewave), often used in choppers, inverters and converters in aircraft, missiles, etc., equipment.

ABSOLUTE MAXIMUM RATINGS

Peak Inverse Voltage	100 to 600V
Maximum Average D.C. Output Current	See Electrical Specifications
Non-Repetitive Sinusoidal Surge (8.3ms)	See Electrical Specifications
Operating and Storage Temperature Range, T_C	-65°C to +150°C
Thermal Resistance Junction to Ambient, All Series	20°C/W
Junction to Case, 678, 682 Series	1.5°C/W
Junction to Case, 695, 696 Series	3.0°C/W

MECHANICAL SPECIFICATIONS

678, 682, 695, 696 SERIES

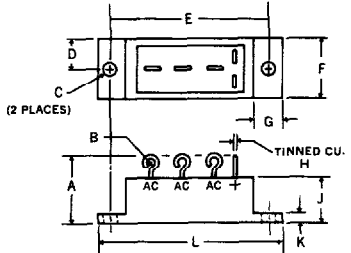

	ins.	mm.
A	.820 MAX.	20.83 MAX.
B	.09 DIA. TYP.	2.29 DIA. TYP.
C	.164-.174 DIA.	4.17-4.42 DIA.
D	.365-.385	9.27-9.78
E	1.870-1.880	47.50-47.75
F	.740-.760	18.80-19.30
G	.370-.390	9.40-9.91
H	.040 TYP.	1.02 TYP.
J	.486-.506	12.34-12.85
K	.115-.135	2.92-3.43
L	2.240-2.260	56.90-57.40

Typical Weight — 30 grams

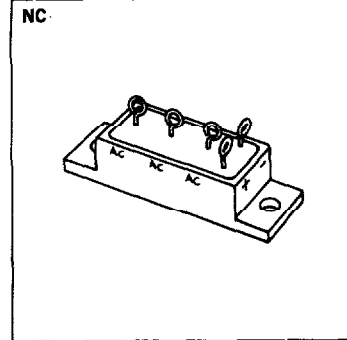

MARKING

Alternating Current Input	A.C.
Cathode — Positive Output	+
Anode — Negative	-

Part number is printed on the body.

Microsemi Corp.
Watertown
The diode experts

Electrical Specifications (at 25°C unless noted)						Maximum Ratings			
Type	PIV Per Leg	Maximum Forward Voltage Drop Per Leg	Maximum Leakage Current Per Leg @ PIV		Maximum Reverse Recovery Time*	Maximum Average D.C. Output Current		Non-Repetitive Sinusoidal Surge (8.3ms) T _A = 100°C	
			T _A = 25°C	T _A = 100°C		T _C = 55°C	T _C = 100°C		
	Volts		μA	μA	ns	Amps	Amps	Amps	
Standard Recovery	678-1	100	1.2V @ 10A	10	200	—	25	18.5	150
	678-2	200							
	678-3	300							
	678-4	400							
	678-5	500							
	678-6	600							
Standard Recovery	695-1	100	1.2V @ 2A	5	150	—	15	9	80
	695-2	200							
	695-3	300							
	695-4	400							
	695-5	500							
	695-6	600							
Fast Recovery	682-1	100	1.2V @ 6A	10	200	500	20	14	150
	682-2	200							
	682-3	300							
	682-4	400							
	682-5	500							
	682-6	600							
Fast Recovery	696-1	100	1.2V @ 2A	5	150	500	15	9	60
	696-2	200							
	696-3	300							
	696-4	400							
	696-5	500							
	696-6	600							

*Measured in a reverse recovery circuit switching from 1.0A forward to 1.0A reverse current recovering to 0.5A.

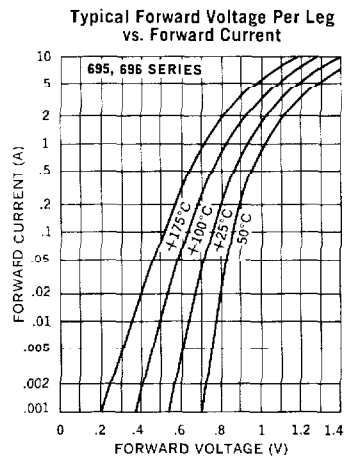
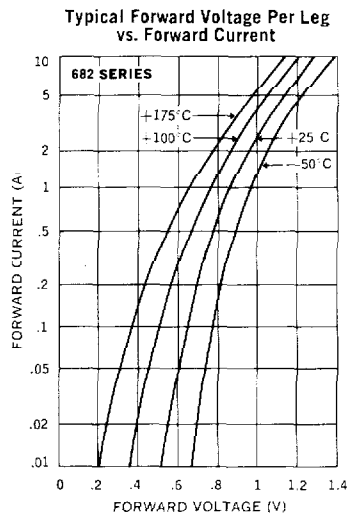
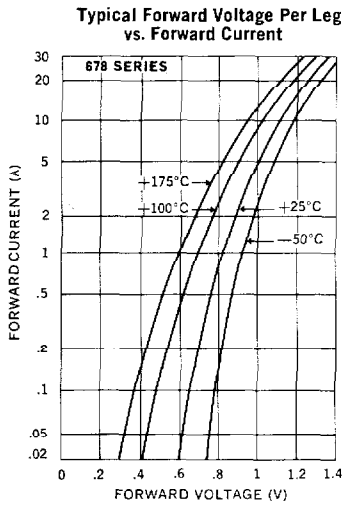

Typical Leakage Current vs. PIV

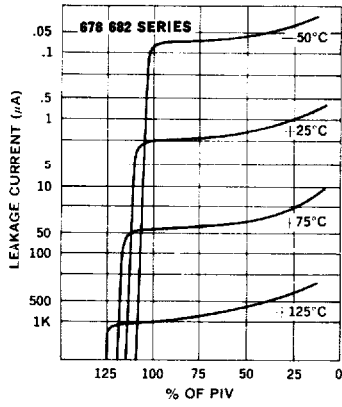

Typical Leakage Current vs. PIV

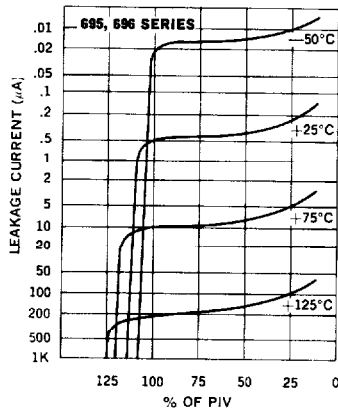

Reverse Recovery Circuit

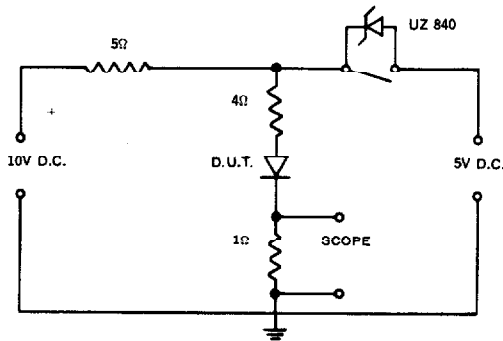

Current Derating Curve

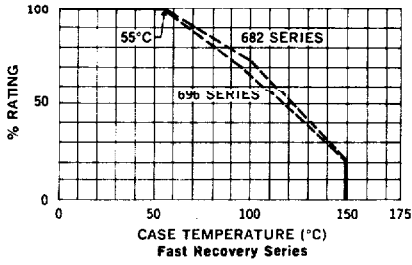

Current Derating Curve

