



N-Channel 30-V (D-S) MOSFET

PRODUCT SUMMARY		
V _{DS} (V)	r _{DS(on)} (Ω)	I _D (A)
30	0.003 @ V _{GS} = 10 V	29
	0.00425 @ V _{GS} = 4.5 V	25

FEATURES

- TrenchFET® Power MOSFET
- PWM Optimized
- New Low Thermal Resistance PowerPAK™ Package with Low 1.07-mm Profile

APPLICATIONS

- DC/DC Converters
 - Low-Side MOSFET in Synchronous Buck in Desktops
- Secondary Synchronous Rectifier

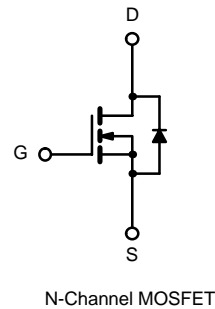
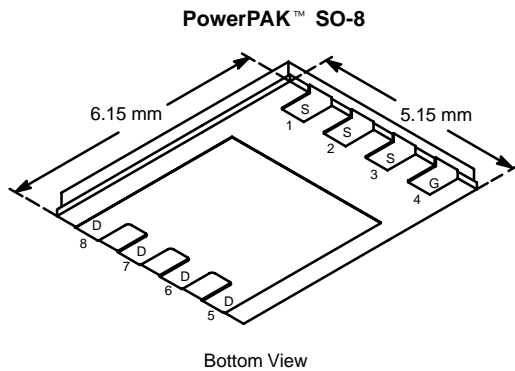

ABSOLUTE MAXIMUM RATINGS (T _A = 25 °C UNLESS OTHERWISE NOTED)					
Parameter	Symbol	10 secs	Steady State	Unit	
Drain-Source Voltage	V _{DS}	30		V	
Gate-Source Voltage	V _{GS}	± 20			
Continuous Drain Current (T _J = 150 °C) ^a	I _D	T _A = 25 °C	29	18	A
		T _A = 70 °C	25	14	
Pulsed Drain Current (10 μs Pulse Width)	I _{DM}	60			
Continuous Source Current (Diode Conduction) ^a	I _S	4.5	1.6		
Maximum Power Dissipation ^a	P _D	T _A = 25 °C	5.4	1.9	W
		T _A = 70 °C	3.4	1.2	
Operating Junction and Storage Temperature Range	T _J , T _{stg}	-55 to 150		°C	

THERMAL RESISTANCE RATINGS					
Parameter	Symbol	Typical	Maximum	Unit	
Maximum Junction-to-Ambient ^a	R _{thJA}	t ≤ 10 sec	18	23	°C/W
		Steady State	50	65	
Maximum Junction-to-Case (Drain)	R _{thJC}	1.0	1.5		

Notes

a. Surface Mounted on 1" x 1" FR4 Board.

SPECIFICATIONS (T_J = 25 °C UNLESS OTHERWISE NOTED)

Parameter	Symbol	Test Condition	Min	Typ	Max	Unit
Static						
Gate Threshold Voltage	V _{GS(th)}	V _{DS} = V _{GS} , I _D = 250 μA	1.0		3.0	V
Gate-Body Leakage	I _{GSS}	V _{DS} = 0 V, V _{GS} = ±20 V			±100	nA
Zero Gate Voltage Drain Current	I _{DSS}	V _{DS} = 24 V, V _{GS} = 0 V			1	μA
		V _{DS} = 24 V, V _{GS} = 0 V, T _J = 55 °C			5	
On-State Drain Current ^a	I _{D(on)}	V _{DS} ≥ 5 V, V _{GS} = 10 V	30			A
Drain-Source On-State Resistance ^a	r _{DS(on)}	V _{GS} = 10 V, I _D = 29 A		0.0025	0.0030	Ω
		V _{GS} = 4.5 V, I _D = 25 A		0.0035	0.00425	
Forward Transconductance ^a	g _{fs}	V _{DS} = 6 V, I _D = 29 A		90		S
Diode Forward Voltage ^a	V _{SD}	I _S = 4.5 A, V _{GS} = 0 V		0.68	1.1	V
Dynamic^b						
Total Gate Charge	Q _g	V _{DS} = 15 V, V _{GS} = 4.5 V, I _D = 29 A		40.5	60	nC
Gate-Source Charge	Q _{gs}			18		
Gate-Drain Charge	Q _{gd}			10.5		
Gate Resistance	R _g			1.2		Ω
Turn-On Delay Time	t _{d(on)}	V _{DD} = 15 V, R _L = 15 Ω I _D ≅ 1 A, V _{GEN} = 10 V, R _G = 6 Ω		30	50	ns
Rise Time	t _r			15	25	
Turn-Off Delay Time	t _{d(off)}			110	200	
Fall Time	t _f			35	60	
Source-Drain Reverse Recovery Time	t _{rr}	I _F = 2.9 A, di/dt = 100 A/μs		55	80	

Notes

- a. Pulse test; pulse width ≤ 300 μs, duty cycle ≤ 2%.
b. Guaranteed by design, not subject to production testing.

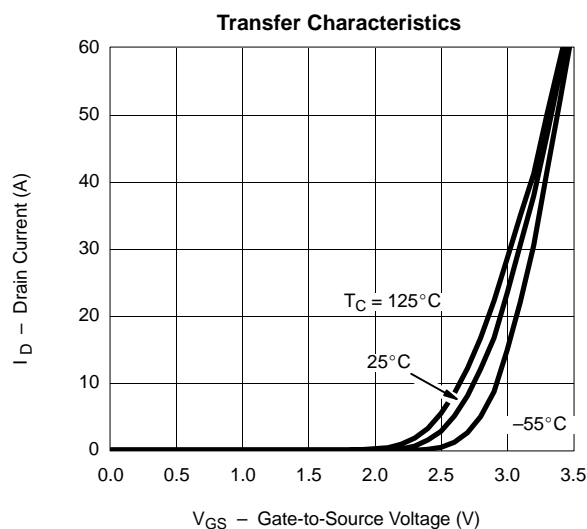
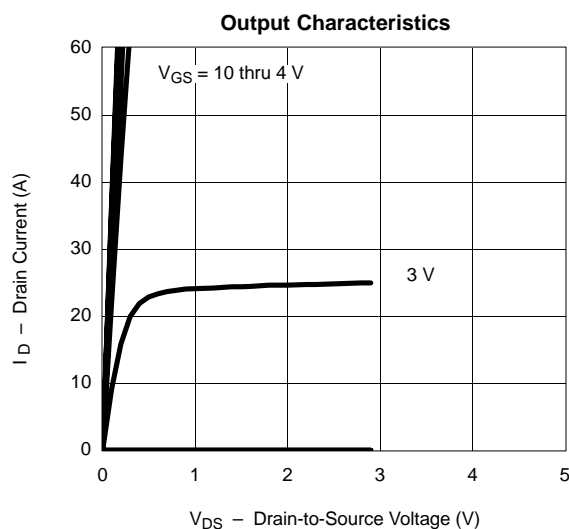
TYPICAL CHARACTERISTICS (25 °C UNLESS NOTED)



TYPICAL CHARACTERISTICS (25°C UNLESS NOTED)

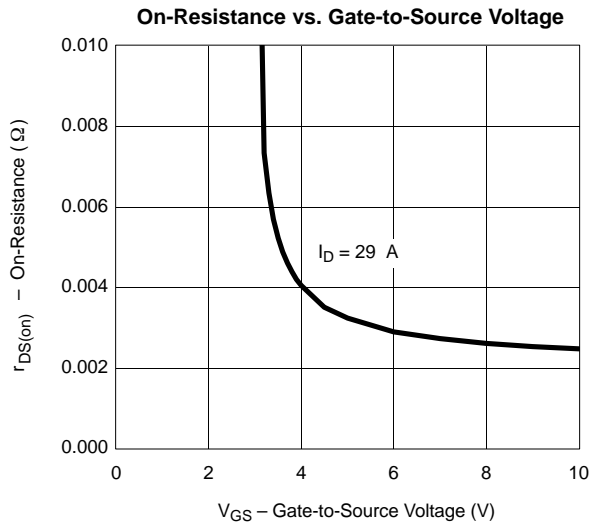
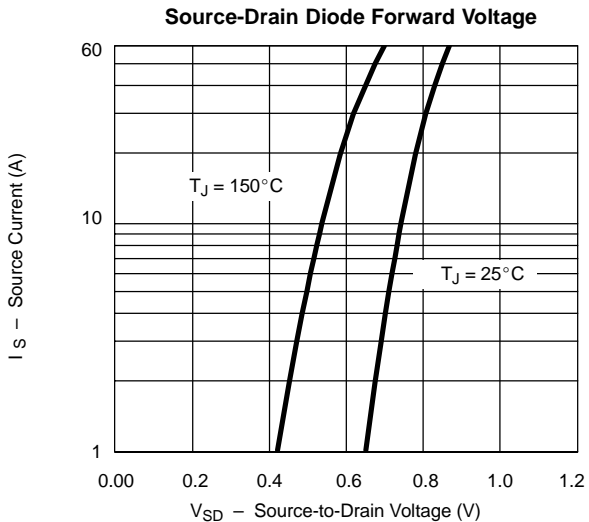
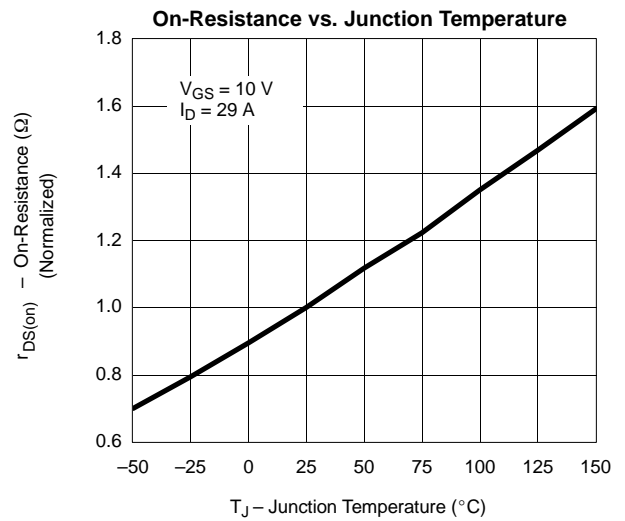
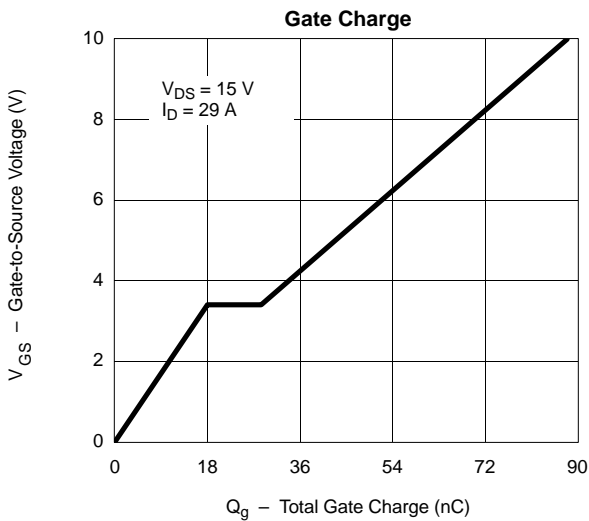
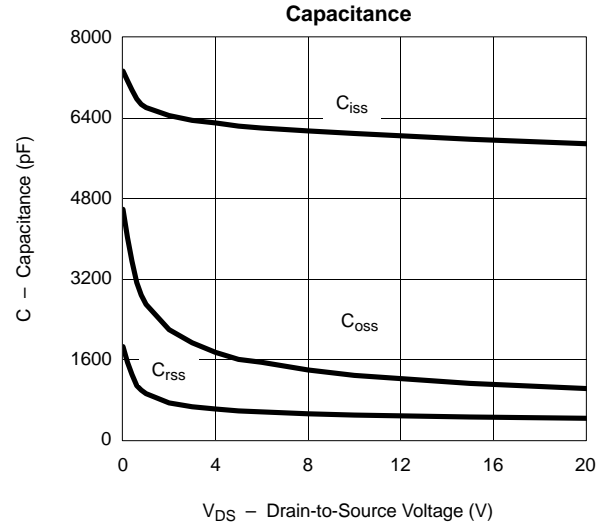
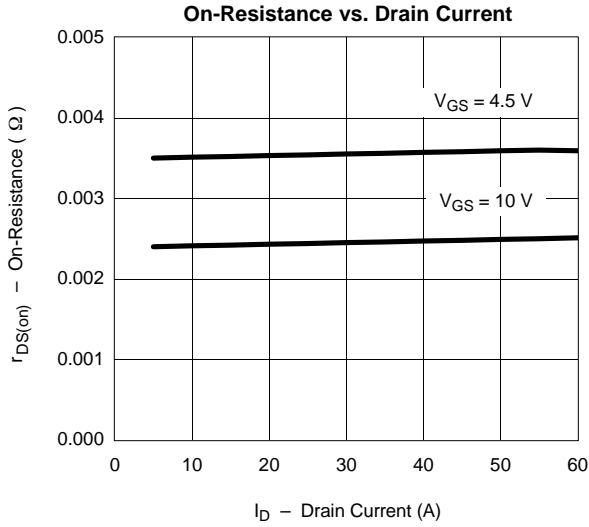

TYPICAL CHARACTERISTICS (25°C UNLESS NOTED)

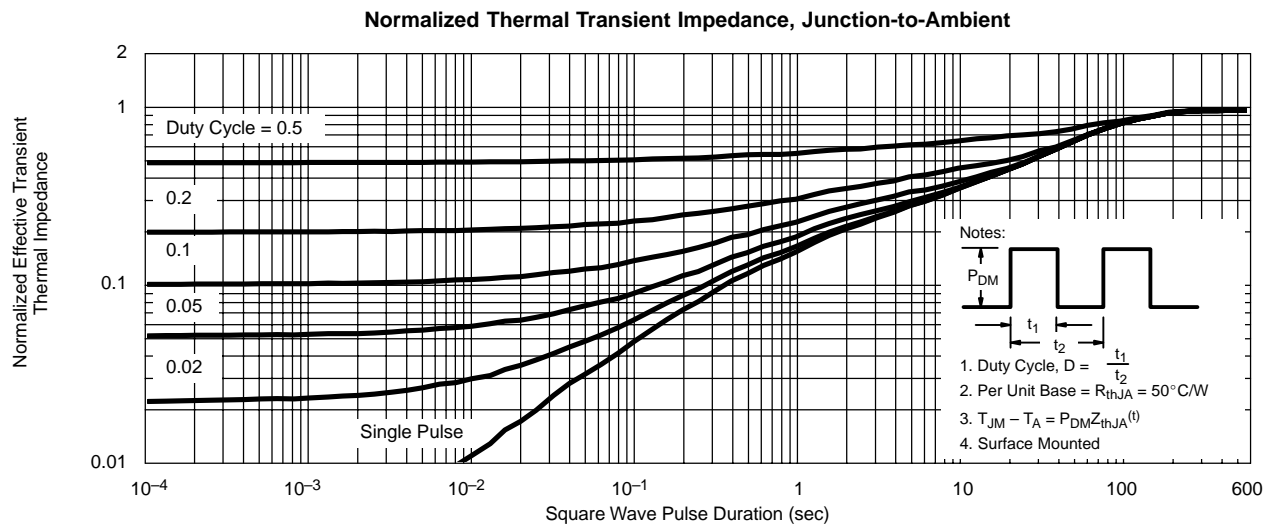
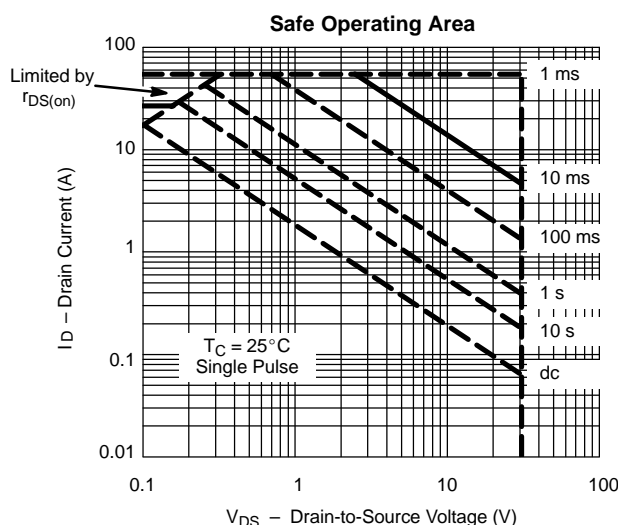
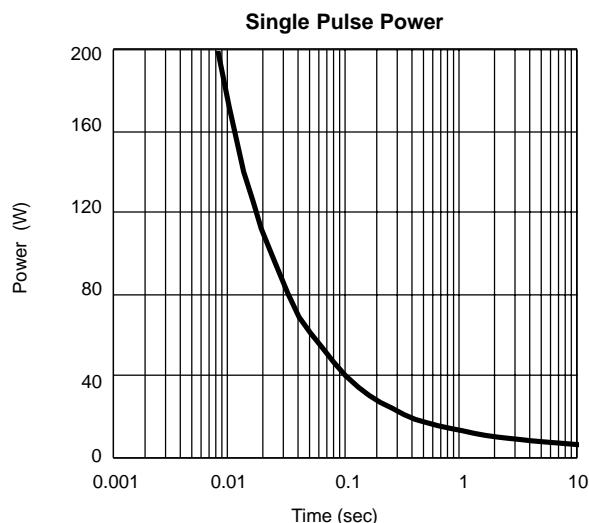
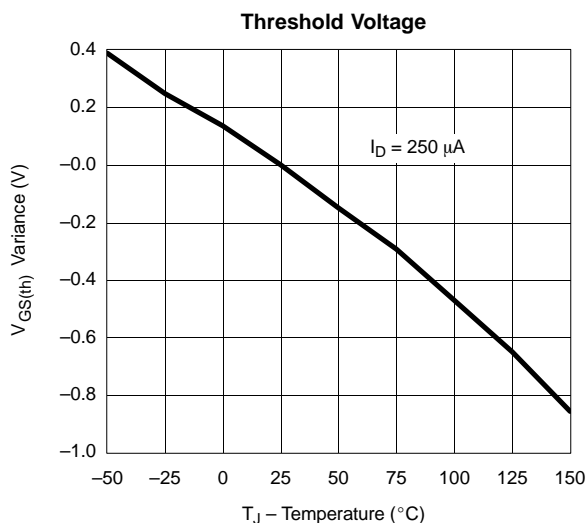



TYPICAL CHARACTERISTICS (25°C UNLESS NOTED)

