

74LVQ151 Low Voltage 8-Input Multiplexer

General Description

The LVQ151 is a high-speed 8-input digital multiplexer. It provides, in one package, the ability to select one line of data from up to eight sources. The LVQ151 can be used as a universal function generator to generate any logic function of four variables. Both true and complementary outputs are provided.

Features

- Ideal for low power/low noise 3.3V applications
- Guaranteed simultaneous switching noise level and dynamic threshold performance
- Guaranteed pin-to-pin skew AC performance
- Guaranteed incident wave switching into 75Ω

Ordering Code:

Order Number	Package Number	Package Description
74LVQ151SC	M16A	16-Lead Small Outline Integrated Circuit (SOIC), JEDEC MS-012, 0.150" Narrow
74LVQ151SJ	M16D	16-Lead Small Outline Package (SOP), EIAJ TYPE II, 5.3mm Wide

Devices also available in Tape and Reel. Specify by appending suffix letter "X" to the ordering code.

Logic Symbols

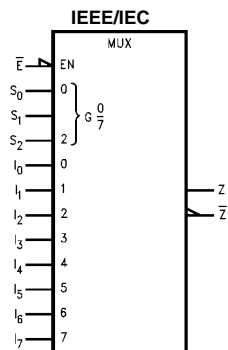
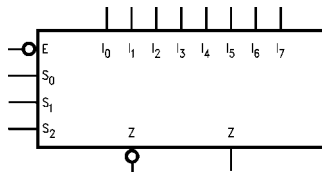

Connection Diagram

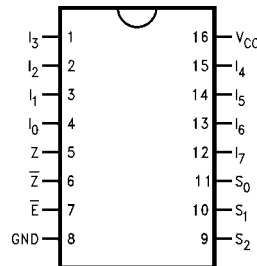

Pin Descriptions

Pin Names	Description
I ₀ -I ₇	Data Inputs
S ₀ -S ₂	Select Inputs
\bar{E}	Enable Input
Z	Data Output
\bar{Z}	Inverted Data Output

Truth Table

Inputs				Outputs	
\bar{E}	S_2	S_1	S_0	\bar{Z}	Z
H	X	X	X	H	L
L	L	L	L	\bar{I}_0	I_0
L	L	L	H	\bar{I}_1	I_1
L	L	H	L	\bar{I}_2	I_2
L	L	H	H	\bar{I}_3	I_3
L	H	L	L	\bar{I}_4	I_4
L	H	L	H	\bar{I}_5	I_5
L	H	H	L	\bar{I}_6	I_6
L	H	H	H	\bar{I}_7	I_7

H = HIGH Voltage Level
 L = LOW Voltage Level
 X = Immaterial

Functional Description

The LVQ151 is a logic implementation of a single pole, 8-position switch with the switch position controlled by the state of three Select inputs, S_0, S_1, S_2 . Both true and complementary outputs are provided. The Enable input (\bar{E}) is active LOW. When it is not activated, the complementary output is HIGH and the true output is LOW regardless of all other inputs. The logic function provided at the output is:

$$Z = \bar{E} \cdot (I_0 \cdot \bar{S}_0 \cdot \bar{S}_1 \cdot \bar{S}_2 + I_1 \cdot S_0 \cdot \bar{S}_1 \cdot \bar{S}_2 + I_2 \cdot \bar{S}_0 \cdot S_1 \cdot \bar{S}_2 + I_3 \cdot S_0 \cdot S_1 \cdot \bar{S}_2 + I_4 \cdot \bar{S}_0 \cdot \bar{S}_1 \cdot S_2 + I_5 \cdot S_0 \cdot \bar{S}_1 \cdot S_2 + I_6 \cdot \bar{S}_0 \cdot S_1 \cdot S_2 + I_7 \cdot S_0 \cdot S_1 \cdot S_2)$$

The LVQ151 provides the ability, in one package to select from eight sources of data or control information. By proper manipulation of the inputs, the LVQ151 can provide any logic function of four variables and its complement.

Logic Diagram

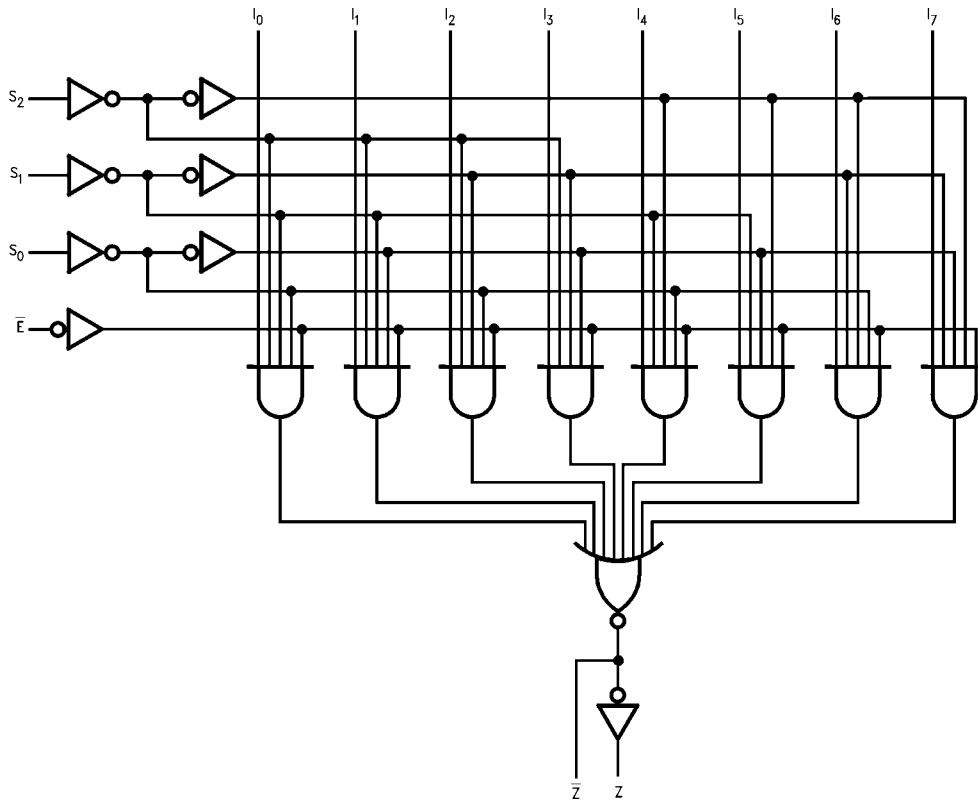

Please note that this diagram is provided only for the understanding of logic operations and should not be used to estimate propagation delays.

Absolute Maximum Ratings(Note 1)

Supply Voltage (V_{CC})	-0.5V to +7.0V
DC Input Diode Current (I_{IK})	
$V_I = -0.5V$	-20 mA
$V_I = V_{CC} + 0.5V$	+20 mA
DC Input Voltage (V_I)	-0.5V to $V_{CC} + 0.5V$
DC Output Diode Current (I_{OK})	
$V_O = -0.5V$	-20 mA
$V_O = V_{CC} + 0.5V$	+20 mA
DC Output Voltage (V_O)	-0.5V to $V_{CC} + 0.5V$
DC Output Source or Sink Current (I_O)	± 50 mA
DC V_{CC} or Ground Current (I_{CC} or I_{GND})	± 200 mA
Storage Temperature (T_{STG})	-65°C to +150°C
DC Latch-Up Source or Sink Current	± 100 mA

Recommended Operating Conditions (Note 2)

Supply Voltage (V_{CC})	2.0V to 3.6V
Input Voltage (V_I)	0V to V_{CC}
Output Voltage (V_O)	0V to V_{CC}
Operating Temperature (T_A)	-40°C to +85°C
Minimum Input Edge Rate ($\Delta V/\Delta t$)	
V_{IN} from 0.8V to 2.0V	
V_{CC} @ 3.0V	125 mV/ns

Note 1: The "Absolute Maximum Ratings" are those values beyond which the safety of the device cannot be guaranteed. The device should not be operated at these limits. The parametric values defined in the Electrical Characteristics tables are not guaranteed at the absolute maximum ratings. The "Recommended Operating Conditions" table will define the conditions for actual device operation.

Note 2: Unused inputs must be held HIGH or LOW. They may not float.

DC Electrical Characteristics

Symbol	Parameter	V_{CC} (V)	$T_A = +25^\circ\text{C}$		$T_A = -40^\circ\text{C to } +85^\circ\text{C}$ Guaranteed Limits	Units	Conditions
			Typ				
V_{IH}	Minimum High Level Input Voltage	3.0	1.5	2.0	2.0	V	$V_{OUT} = 0.1V$ or $V_{CC} - 0.1V$
V_{IL}	Maximum Low Level Input Voltage	3.0	1.5	0.8	0.8	V	$V_{OUT} = 0.1V$ or $V_{CC} - 0.1V$
V_{OH}	Minimum High Level Output Voltage	3.0	2.99	2.9	2.9	V	$I_{OUT} = -50 \mu\text{A}$
		3.0		2.58	2.48	V	$V_{IN} = V_{IL}$ or V_{IH} (Note 3) $I_{OH} = -12 \text{ mA}$
V_{OL}	Maximum Low Level Output Voltage	3.0	0.002	0.1	0.1	V	$I_{OUT} = 50 \mu\text{A}$
		3.0		0.36	0.44	V	$V_{IN} = V_{IL}$ or V_{IH} (Note 3) $I_{OL} = 12 \text{ mA}$
I_{IN}	Maximum Input Leakage Current	3.6		± 0.1	± 1.0	μA	$V_I = V_{CC}$, GND
I_{OLD}	Minimum Dynamic	3.6			36	mA	$V_{OLD} = 0.8V$ Max (Note 5)
I_{OHD}	Output Current (Note 4)	3.6			-25	mA	$V_{OHD} = 2.0V$ (Note 5)
I_{CC}	Maximum Quiescent Supply Current	3.6		4.0	40.0	μA	$V_{IN} = V_{CC}$ or GND
V_{OLP}	Quiet Output Maximum Dynamic V_{OL}	3.3		0.8		V	(Note 6)(Note 7)
V_{OLV}	Quiet Output Minimum Dynamic V_{OL}	3.3		-0.8		V	(Note 6)(Note 7)
V_{IHD}	Maximum High Level Dynamic Input Voltage	3.3	1.7	2.0		V	(Note 6)(Note 8)
V_{ILD}	Maximum Low Level Dynamic Input Voltage	3.3	1.7	0.8		V	(Note 6)(Note 8)

Note 3: All outputs loaded; thresholds on input associated with output under test.

Note 4: Maximum test duration 2.0 ms, one output loaded at a time.

Note 5: Incident wave switching on transmission lines with impedances as low as 75 Ω for commercial temperature range is guaranteed for 74LVQ.

Note 6: Worst case package.

Note 7: Max number of outputs defined as (n). Data inputs are driven 0V to 3.3V; one output at GND.

Note 8: Max number of Data Inputs (n) switching. (n - 1) inputs switching 0V to 3.3V. Input-under-test switching: 3.3V to threshold (V_{ILD}), 0V to threshold (V_{IHD}), $f = 1 \text{ MHz}$.

AC Electrical Characteristics

Symbol	Parameter	V _{CC} (V)	T _A = +25°C C _L = 50 pF			T _A = -40°C to +85°C C _L = 50 pF		Units
			Min	Typ	Max	Min	Max	
t _{PLH}	Propagation Delay	2.7	3.0	13.8	25.3	3.0	28.0	ns
	S _n to Z or \bar{Z}	3.3 ± 0.3	3.0	11.5	18.0	3.0	20.0	
t _{PHL}	Propagation Delay	2.7	2.5	14.4	25.3	2.5	28.0	ns
	S _n to Z or \bar{Z}	3.3 ± 0.3	2.5	12.0	18.0	2.5	20.0	
t _{PLH}	Propagation Delay	2.7	2.5	9.6	18.3	2.0	20.0	ns
	\bar{E} to Z or \bar{Z}	3.3 ± 0.3	2.5	8.0	13.0	2.0	14.0	
t _{PHL}	Propagation Delay	2.7	1.5	10.2	18.3	1.5	20.0	ns
	\bar{E} to Z or \bar{Z}	3.3 ± 0.3	1.5	8.5	13.0	1.5	14.0	
t _{PLH}	Propagation Delay	2.7	2.5	11.4	19.7	2.0	22.0	ns
	I _n to Z or \bar{Z}	3.3 ± 0.3	2.5	9.5	14.0	2.0	15.5	
t _{PHL}	Propagation Delay	2.7	2.5	11.4	21.1	2.0	23.0	ns
	I _n to Z or \bar{Z}	3.3 ± 0.3	2.5	9.5	15.0	2.0	16.0	
t _{OSSL}	Output to Output Skew (Note 9)	2.7		1.0	1.5		1.5	ns
t _{OSLH}	Data to Output	3.3 ± 0.3		1.0	1.5		1.5	

Note 9: Skew is defined as the absolute value of the difference between the actual propagation delay for any two separate outputs of the same device. The specification applies to any outputs switching in the same direction, either HIGH-to-LOW (t_{OSSL}) or LOW-to-HIGH (t_{OSLH}). Parameter guaranteed by design.

Capacitance

Symbol	Parameter	Typ	Units	Conditions
C _{IN}	Input Capacitance	4.5	pF	V _{CC} = Open
C _{PD} (Note 10)	Power Dissipation Capacitance	45	pF	V _{CC} = 3.3V

Note 10: C_{PD} is measured at 10 MHz.

Physical Dimensions inches (millimeters) unless otherwise noted



**16-Lead Small Outline Integrated Circuit (SOIC), JEDEC MS-012, 0.150" Narrow
Package Number M16A**

Physical Dimensions inches (millimeters) unless otherwise noted (Continued)

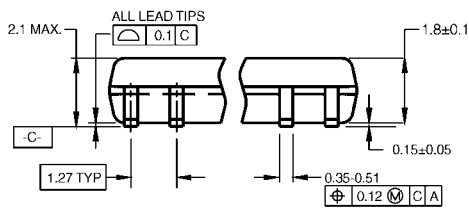
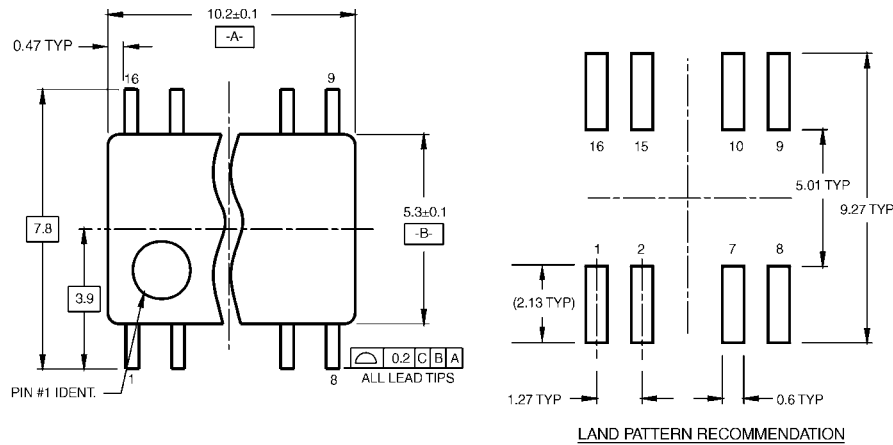

DIMENSIONS ARE IN MILLIMETERS

NOTES:

- A. CONFORMS TO EIAJ EDR-7320 REGISTRATION, ESTABLISHED IN DECEMBER, 1998.
- B. DIMENSIONS ARE IN MILLIMETERS.
- C. DIMENSIONS ARE EXCLUSIVE OF BURRS, MOLD FLASH, AND TIE BAR EXTRUSIONS.

M16DRevB1

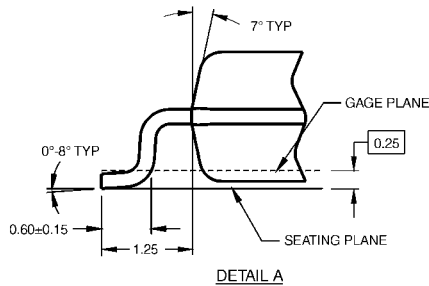
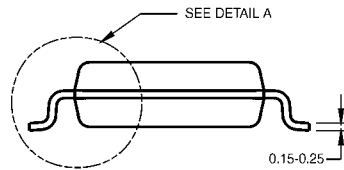

16-Lead Small Outline Package (SOP), EIAJ TYPE II, 5.3mm Wide Package Number M16D

Fairchild does not assume any responsibility for use of any circuitry described, no circuit patent licenses are implied and Fairchild reserves the right at any time without notice to change said circuitry and specifications.

LIFE SUPPORT POLICY

FAIRCHILD'S PRODUCTS ARE NOT AUTHORIZED FOR USE AS CRITICAL COMPONENTS IN LIFE SUPPORT DEVICES OR SYSTEMS WITHOUT THE EXPRESS WRITTEN APPROVAL OF THE PRESIDENT OF FAIRCHILD SEMICONDUCTOR CORPORATION. As used herein:

1. Life support devices or systems are devices or systems which, (a) are intended for surgical implant into the body, or (b) support or sustain life, and (c) whose failure to perform when properly used in accordance with instructions for use provided in the labeling, can be reasonably expected to result in a significant injury to the user.
2. A critical component in any component of a life support device or system whose failure to perform can be reasonably expected to cause the failure of the life support device or system, or to affect its safety or effectiveness.

www.fairchildsemi.com