

## 74VCXF162835

# Low Voltage 18-Bit Universal Bus Driver with 3.6V Tolerant Outputs and 26Ω Series Resistors in Outputs

### General Description

The VCXF162835 low voltage 18-bit universal bus driver combines D-type latches and D-type flip-flops to allow data flow in transparent, latched and clocked modes.

Data flow is controlled by output-enable ( $\overline{OE}$ ), latch-enable (LE), and clock (CLK) inputs. The device operates in Transparent Mode when LE is held HIGH. The device operates in clocked mode when LE is LOW and CLK is toggled. Data transfers from the Inputs ( $I_n$ ) to Outputs ( $O_n$ ) on a Positive Edge Transition of the Clock. When  $\overline{OE}$  is LOW, the output data is enabled. When  $\overline{OE}$  is HIGH the output port is in a high impedance state.

The VCXF162835 is designed with 26Ω series resistors in the outputs. This design reduces noise in applications such as memory address drivers, clock drivers, and bus transceivers/transmitters.

The 74VCXF162835 is designed for low voltage (1.65V to 3.6V)  $V_{CC}$  applications with I/O capability up to 3.6V.

The 74VCXF162835 is fabricated with an advanced CMOS technology to achieve high speed operation while maintaining low CMOS power dissipation.

### Features

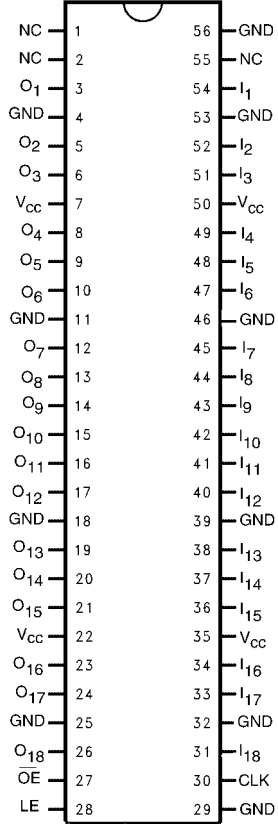
- Compatible with PC133 DIMM module specifications
- 1.65V–3.6V  $V_{CC}$  specifications provided
- 3.6V tolerant outputs
- 26Ω series resistors in outputs
- $t_{PD}$  (CLK to  $O_n$ )
  - 3.2 ns max for 3.0V to 3.6V  $V_{CC}$
  - 4.1 ns max for 2.3V to 2.7V  $V_{CC}$
  - 7.4 ns max for 1.65V to 1.95V  $V_{CC}$
- Power-down high impedance outputs
- Static Drive ( $I_{OH}/I_{OL}$ )
  - ±12 mA @ 3.0V  $V_{CC}$
  - ±8 mA @ 2.3V  $V_{CC}$
  - ±3 mA @ 1.65V  $V_{CC}$
- Latchup performance exceeds 300 mA
- ESD performance:
  - Human body model > 2000V
  - Machine model >200V

### Ordering Code:

Order Number	Package Number	Package Description
74VCXF162835MTD	MTD56	56-Lead Thin Shrink Small Outline Package (TSSOP), JEDEC MO-153, 6.1mm Wide [TUBES]
74VCXF162835MTX (Note 1)	MTD56	56-Lead Thin Shrink Small Outline Package (TSSOP), JEDEC MO-153, 6.1mm Wide [TAPE and REEL]

**Note 1:** Use this Order Number to receive devices in Tape and Reel.

### Connection Diagram



### Pin Descriptions

Pin Names	Description
$\overline{OE}$	Output Enable Input (Active LOW)
LE	Latch Enable Input
CLK	Clock Input
$I_1 - I_{18}$	Data Inputs
$O_1 - O_{18}$	3-STATE Outputs

### Truth Table

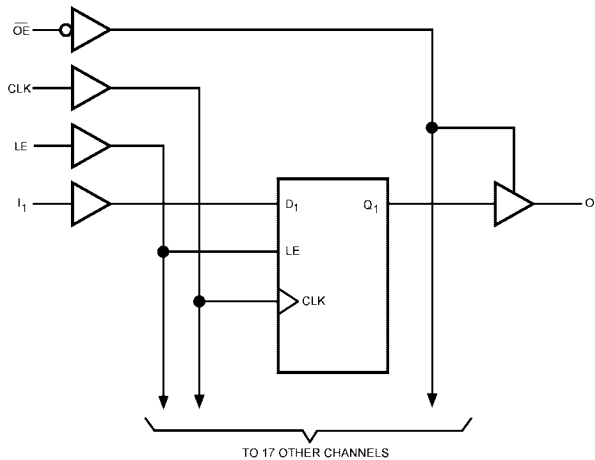
Inputs				Outputs
$\overline{OE}$	LE	CLK	$I_n$	$O_n$
H	X	X	X	Z
L	H	X	L	L
L	H	X	H	H
L	L	↑	L	L
L	L	↑	H	H
L	L	H	X	$O_0$ (Note 2)
L	L	L	X	$O_0$ (Note 3)

H = Logic HIGH  
 L = Logic LOW  
 X = Don't Care, but not floating  
 Z = High Impedance  
 ↑ = LOW-to-HIGH Clock Transition

**Note 2:** Output level before the indicated steady-state input conditions were established provided that CLK was HIGH before LE went LOW.

**Note 3:** Output level before the indicated steady-state input conditions were established.

### Logic Diagram



**Absolute Maximum Ratings**(Note 4)

Supply Voltage ( $V_{CC}$ )	-0.5V to +4.6V
DC Input Voltage ( $V_I$ )	-0.5V to $V_{CC} + 0.5V$
Output Voltage ( $V_O$ )	
Outputs 3-STATE	-0.5V to +4.6V
Outputs Active (Note 5)	-0.5V to $V_{CC} + 0.5V$
DC Input Diode Current ( $I_{IK}$ )	
$V_I < -0.5V$	-50 mA
$V_I > V_{CC} + 0.5V$ (Note 6)	+50 mA
DC Output Diode Current ( $I_{OK}$ )	
$V_O < 0V$	-50 mA
$V_O > V_{CC}$	+50 mA
DC Output Source/Sink Current ( $I_{OH}/I_{OL}$ )	±50 mA
DC $V_{CC}$ or Ground Current per Supply Pin ( $I_{CC}$ or Ground)	±100 mA
Storage Temperature Range ( $T_{STG}$ )	-65°C to +150°C

**Recommended Operating Conditions** (Note 7)

Power Supply	
Operating	1.65V to 3.6V
Data Retention Only	1.2V to 3.6V
Input Voltage	-0.3V to $V_{CC}$
Output Voltage ( $V_O$ )	
Output in Active States	0V to $V_{CC}$
Output in 3-STATE	0V to 3.6V
Output Current in $I_{OH}/I_{OL}$	
$V_{CC} = 3.0V$ to 3.6V	±12 mA
$V_{CC} = 2.3V$ to 2.7V	±8 mA
$V_{CC} = 1.65V$ to 2.3V	±3 mA
Free Air Operating Temperature ( $T_A$ )	-40°C to +85°C
Minimum Input Edge Rate ( $\Delta t/\Delta V$ )	
$V_{IN} = 0.8V$ to 2.0V, $V_{CC} = 3.0V$	10 ns/V

**Note 4:** The "Absolute Maximum Ratings" are those values beyond which the safety of the device cannot be guaranteed. The device should not be operated at these limits. The parametric values defined in the Electrical Characteristics tables are not guaranteed at the Absolute Maximum Ratings. The Recommended Operating Conditions tables will define the conditions for actual device operation.

**Note 5:**  $I_O$  Absolute Maximum Rating must be observed.

**Note 6:** Inputs do not have over-voltage tolerance.

**Note 7:** Floating or unused pin (inputs or I/O's) must be held HIGH or LOW.

**DC Electrical Characteristics (2.7V <  $V_{CC}$  ≤ 3.6V)**

Symbol	Parameter	Conditions	$V_{CC}$ (V)	Min	Max	Units
$V_{IH}$	HIGH Level Input Voltage		2.7-3.6	2.0		V
$V_{IL}$	LOW Level Input Voltage		2.7-3.6		0.8	V
$V_{OH}$	HIGH Level Output Voltage	$I_{OH} = -100 \mu A$	2.7-3.6	$V_{CC} - 0.2$		V
		$I_{OH} = -6 \text{ mA}$	2.7	2.2		
		$I_{OH} = -8 \text{ mA}$	3.0	2.4		
		$I_{OH} = -12 \text{ mA}$	3.0	2.2		
$V_{OL}$	LOW Level Output Voltage	$I_{OL} = 100 \mu A$	2.7-3.6		0.2	V
		$I_{OL} = 6 \text{ mA}$	2.7		0.4	
		$I_{OL} = 8 \text{ mA}$	3.0		0.55	
		$I_{OL} = 12 \text{ mA}$	3.0		0.8	
$I_I$	Input Leakage Current	$V_I = V_{CC}$ or GND	2.7-3.6		±5.0	μA
$I_{OZ}$	3-STATE Output Leakage	$0V \leq V_O \leq 3.6V$	2.7-3.6		±10	μA
	$V_I = V_{IH}$ or $V_{IL}$					
$I_{OFF}$	Power Off Leakage Current	$0V \leq (V_O) \leq 3.6V$	0		10	μA
$I_{CC}$	Quiescent Supply Current	$V_I = V_{CC}$ or GND	2.7-3.6		20	μA
		$V_{CC} \leq (V_O) \leq 3.6V$ (Note 8)			±20	
$\Delta I_{CC}$	Increase in $I_{CC}$ per Input	$V_{IH} = V_{CC} - 0.6V$	2.7-3.6		750	μA

**Note 8:** Outputs disabled or 3-STATE only.

### DC Electrical Characteristics ( $2.3V \leq V_{CC} \leq 2.7V$ )

Symbol	Parameter	Conditions	V <sub>CC</sub> (V)	Min	Max	Units
V <sub>IH</sub>	HIGH Level Input Voltage		2.3-2.7	1.6		V
V <sub>IL</sub>	LOW Level Input Voltage		2.3-2.7		0.7	V
V <sub>OH</sub>	HIGH Level Output Voltage	I <sub>OH</sub> = -100 μA	2.3-2.7	V <sub>CC</sub> - 0.2		V
		I <sub>OH</sub> = -3 mA	2.3	2.0		
		I <sub>OH</sub> = -6 mA	2.3	1.8		
		I <sub>OH</sub> = -8 mA	2.3	1.7		
V <sub>OL</sub>	LOW Level Output Voltage	I <sub>OL</sub> = 100 μA	2.3-2.7		0.2	V
		I <sub>OL</sub> = 6 mA	2.3		0.4	
		I <sub>OL</sub> = 8 mA	2.3		0.6	
I <sub>I</sub>	Input Leakage Current	V <sub>I</sub> = V <sub>CC</sub> or GND	2.3-2.7		±5.0	μA
I <sub>OZ</sub>	3-STATE Output Leakage	0V ≤ V <sub>O</sub> ≤ 3.6V	2.3-2.7		±10	μA
		V <sub>I</sub> = V <sub>IH</sub> or V <sub>IL</sub>				
I <sub>OFF</sub>	Power Off Leakage Current	0V ≤ (V <sub>O</sub> ) ≤ 3.6V	0		10	μA
I <sub>CC</sub>	Quiescent Supply Current	V <sub>I</sub> = V <sub>CC</sub> or GND	2.3-2.7		20	μA
		V <sub>CC</sub> ≤ (V <sub>O</sub> ) ≤ 3.6V (Note 9)			±20	

Note 9: Outputs disabled or 3-STATE only.

### DC Electrical Characteristics ( $1.65V \leq V_{CC} < 2.3V$ )

Symbol	Parameter	Conditions	V <sub>CC</sub> (V)	Min	Max	Units
V <sub>IH</sub>	HIGH Level Input Voltage		1.65 - 2.3	0.65 × V <sub>CC</sub>		V
V <sub>IL</sub>	LOW Level Input Voltage		1.65 - 2.3		0.35 × V <sub>CC</sub>	V
V <sub>OH</sub>	HIGH Level Output Voltage	I <sub>OH</sub> = -100 μA	1.65 - 2.3	V <sub>CC</sub> - 0.2		V
		I <sub>OH</sub> = -3 mA	1.65	1.25		
V <sub>OL</sub>	LOW Level Output Voltage	I <sub>OL</sub> = 100 μA	1.65 - 2.3		0.2	V
		I <sub>OL</sub> = 3 mA	1.65		0.3	
I <sub>I</sub>	Input Leakage Current	V <sub>I</sub> = V <sub>CC</sub> or GND	1.65 - 2.3		±5.0	μA
I <sub>OZ</sub>	3-STATE Output Leakage	0V ≤ V <sub>O</sub> ≤ 3.6V	1.65 - 2.3		±10	μA
		V <sub>I</sub> = V <sub>IH</sub> or V <sub>IL</sub>				
I <sub>OFF</sub>	Power Off Leakage Current	0V ≤ (V <sub>O</sub> ) ≤ 3.6V	0		10	μA
I <sub>CC</sub>	Quiescent Supply Current	V <sub>I</sub> = V <sub>CC</sub> or GND	1.65 - 2.3		20	μA
		V <sub>CC</sub> ≤ (V <sub>O</sub> ) ≤ 3.6V (Note 10)			±20	

Note 10: Outputs disabled or 3-STATE only.

**AC Electrical Characteristics** (Note 11)

Symbol	Parameter	$T_A = -40^\circ\text{C to } +85^\circ\text{C}, C_L = 30 \text{ pF}, R_L = 500\Omega$						Units
		$V_{CC} = 3.3V \pm 0.3V$		$V_{CC} = 2.5 \pm 0.2V$		$V_{CC} = 1.8 \pm 0.15V$		
		Min	Max	Min	Max	Min	Max	
$f_{MAX}$	Maximum Clock Frequency	250		200		100		MHz
$t_{PHL}, t_{PLH}$	Propagation Delay Bus to Bus	0.6	3.1	0.8	4.0	1.5	7.2	ns
$t_{PHL}, t_{PLH}$	Propagation Delay Clock to Bus	1.0	3.2	1.5	4.1	2.0	7.4	ns
$t_{PHL}, t_{PLH}$	Propagation Delay LE to Bus	0.6	3.7	0.8	4.7	1.5	8.5	ns
$t_{PZL}, t_{PZH}$	Output Enable Time	0.6	4.3	0.8	5.9	1.5	9.8	ns
$t_{PLZ}, t_{PHZ}$	Output Disable Time	0.6	4.2	0.8	4.7	1.5	7.9	ns
$t_S$	Setup Time	1.5		1.5		2.5		ns
$t_H$	Hold Time	0.7		0.7		1.0		ns
$t_W$	Pulse Width	1.5		1.5		4.0		ns
$t_{OSHL}$ $t_{OSLH}$	Output to Output Skew (Note 12)		0.5		0.5		0.75	ns

**Note 11:** For  $C_L = 50\text{pF}$ , add approximately 300ps to the AC maximum specification.

**Note 12:** Skew is defined as the absolute value of the difference between the actual propagation delay for any two separate outputs of the same device. The specification applies to any outputs switching in the same direction, either HIGH-to-LOW ( $t_{OSHL}$ ) or LOW-to-HIGH ( $t_{OSLH}$ ).

**AC Electrical Characteristics Over Load** (Note 13)

Symbol	Parameter	$T_A = -0^\circ\text{C to } +85^\circ\text{C}, R_L = 500\Omega, V_{CC} = 3.3V \pm 0.3V$		Units
		$C_L = 50 \text{ pF}$		
		Min	Max	
$t_{PHL}, t_{PLH}$	Propagation Delay Bus to Bus	1.0	3.4	ns
$t_{PHL}, t_{PLH}$	Propagation Delay Clock to Bus	1.4	3.5	ns
$t_{PHL}, t_{PLH}$	Propagation Delay LE to Bus	1.0	4.0	ns
$t_{PZL}, t_{PZH}$	Output Enable Time	1.0	4.6	ns
$t_{PLZ}, t_{PHZ}$	Output Disable Time	1.0	4.5	ns
$t_S$	Setup Time	1.0		ns
$t_H$	Hold Time	0.6		ns

**Note 13:** Characterized only.

**Dynamic Switching Characteristics**

Symbol	Parameter	Conditions	$V_{CC}$ (V)	$T_A = +25^\circ\text{C}$	Units
				Typical	
$V_{OLP}$	Quiet Output Dynamic Peak $V_{OL}$	$C_L = 30 \text{ pF}, V_{IH} = V_{CC}, V_{IL} = 0V$	1.8 2.5 3.3	0.25 0.40 0.55	V
$V_{OLV}$	Quiet Output Dynamic Valley $V_{OL}$	$C_L = 30 \text{ pF}, V_{IH} = V_{CC}, V_{IL} = 0V$	1.8 2.5 3.3	-0.25 -0.40 -0.55	V
$V_{OHV}$	Quiet Output Dynamic Valley $V_{OH}$	$C_L = 30 \text{ pF}, V_{IH} = V_{CC}, V_{IL} = 0V$	1.8 2.5 3.3	1.35 1.80 2.30	V

## Capacitance

Symbol	Parameter	Conditions	$T_A = +25^\circ\text{C}$	
			Typical	Units
$C_{IN}$	Input Capacitance	$V_I = 0\text{V or } V_{CC}, V_{CC} = 1.8\text{V, 2.5V, or 3.3V,}$	3.5	pF
$C_{I/O}$	Input/Output Capacitance	$V_I = 0\text{V, or } V_{CC}, V_{CC} = 1.8\text{V, 2.5V or 3.3V}$	5.5	pF
$C_{PD}$	Power Dissipation Capacitance	$V_I = 0\text{V or } V_{CC}, f = 10\text{ MHz, } V_{CC} = 1.8\text{V, 2.5V or 3.3V}$	13	pF

## $I_{OH} - V_{OH}$ Characteristics

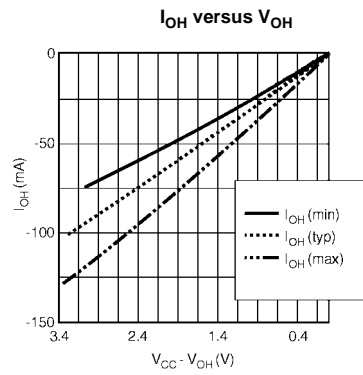


FIGURE 1. Characteristics for Output - Pull Up Drive

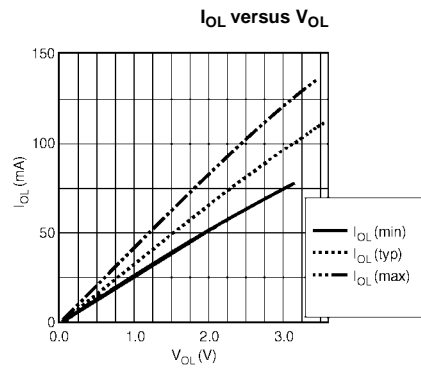
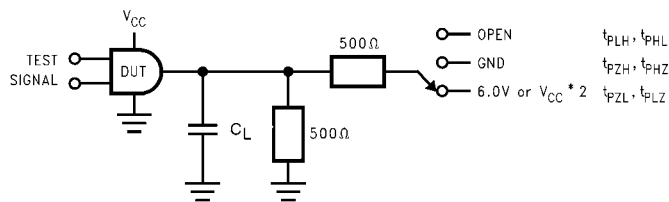


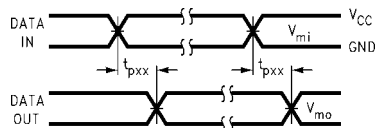
FIGURE 2. Characteristics for Output - Pull Down Driver

**AC Loading and Waveforms**

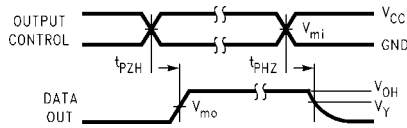


**FIGURE 3. AC Test Circuit**

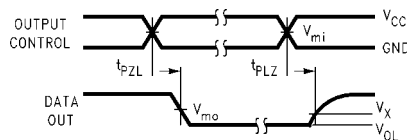
TEST	SWITCH
$t_{PLH}, t_{PHL}$	Open
$t_{PZL}, t_{PLZ}$	6V at $V_{CC} = 3.3 \pm 0.3V$ ; $V_{CC} \times 2$ at $V_{CC} = 2.5 \pm 0.2V$ ; $1.8V$ to $\pm 0.15V$
$t_{PZH}, t_{PHZ}$	GND



**FIGURE 4. Waveform for Inverting and Non-inverting Functions**  
 $t_r = t_f \leq 2.0ns, 10\%$  to  $90\%$



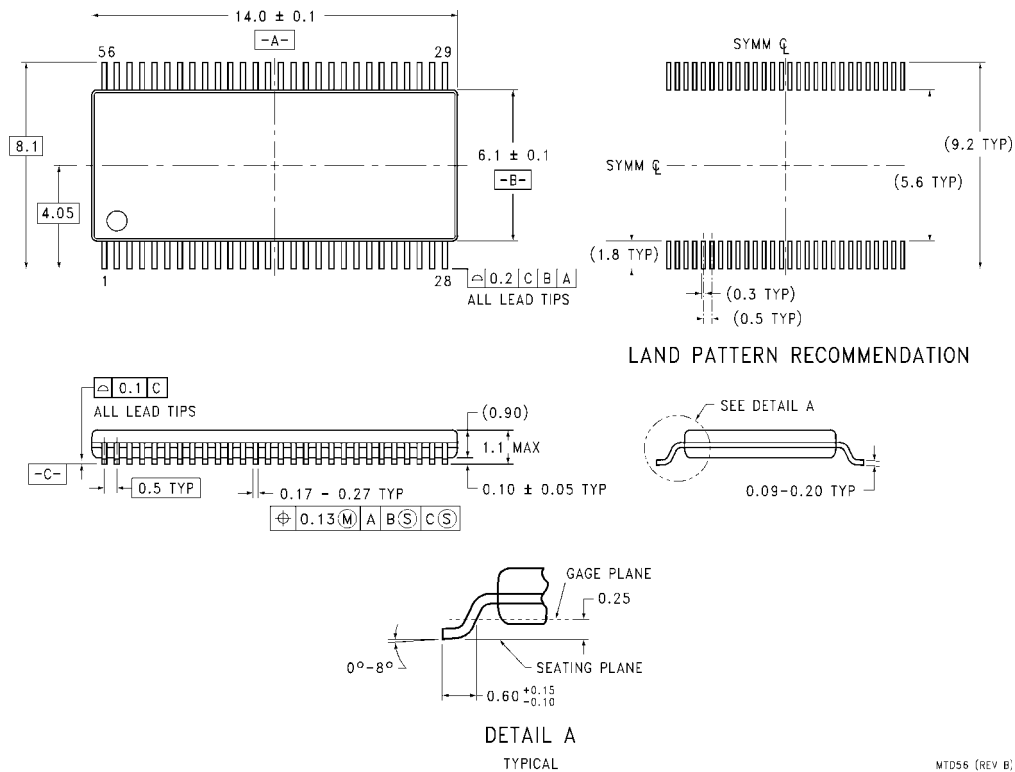
**FIGURE 5. 3-STATE Output High Enable and Disable Times for Low Voltage Logic**  
 $t_r = t_f \leq 2.0ns, 10\%$  to  $90\%$



**FIGURE 6. 3-STATE Output Low Enable and Disable Times for Low Voltage Logic**  
 $t_r = t_f \leq 2.0ns, 10\%$  to  $90\%$

Symbol	$V_{CC}$		
	$3.3V \pm 0.3V$	$2.5V \pm 0.2V$	$1.8 \pm 0.15V$
$V_{mi}$	1.5V	$V_{CC}/2$	$V_{CC}/2$
$V_{mo}$	1.5V	$V_{CC}/2$	$V_{CC}/2$
$V_x$	$V_{OL} + 0.3V$	$V_{OL} + 0.15V$	$V_{OL} + 0.15V$
$V_y$	$V_{OH} - 0.3V$	$V_{OH} - 0.15V$	$V_{OH} - 0.15V$

**Physical Dimensions** inches (millimeters) unless otherwise noted



56-Lead Thin Shrink Small Outline Package (TSSOP), JEDEC MO-153, 6.1mm Wide Package Number MTD56

MTD56 (REV B)

Fairchild does not assume any responsibility for use of any circuitry described, no circuit patent licenses are implied and Fairchild reserves the right at any time without notice to change said circuitry and specifications.

**LIFE SUPPORT POLICY**

FAIRCHILD'S PRODUCTS ARE NOT AUTHORIZED FOR USE AS CRITICAL COMPONENTS IN LIFE SUPPORT DEVICES OR SYSTEMS WITHOUT THE EXPRESS WRITTEN APPROVAL OF THE PRESIDENT OF FAIRCHILD SEMICONDUCTOR CORPORATION. As used herein:

1. Life support devices or systems are devices or systems which, (a) are intended for surgical implant into the body, or (b) support or sustain life, and (c) whose failure to perform when properly used in accordance with instructions for use provided in the labeling, can be reasonably expected to result in a significant injury to the user.
2. A critical component in any component of a life support device or system whose failure to perform can be reasonably expected to cause the failure of the life support device or system, or to affect its safety or effectiveness.

[www.fairchildsemi.com](http://www.fairchildsemi.com)