

# Preliminary Data Sheet

## Features

- For wireless broadband applications
- Usable bandwidth 2.6MHz
- Low loss
- High attenuation
- Single ended operation
- Ceramic Surface Mount Package (SMP)
- Small size

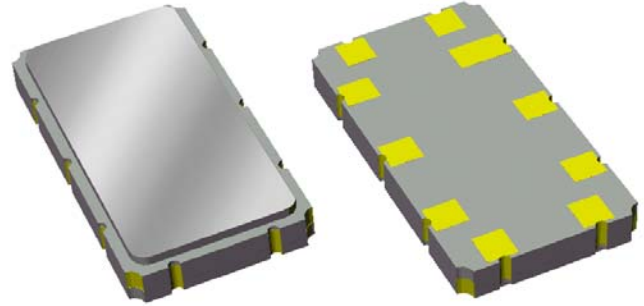

## Package

Surface Mount 9.10 x 4.80 x 1.24 mm

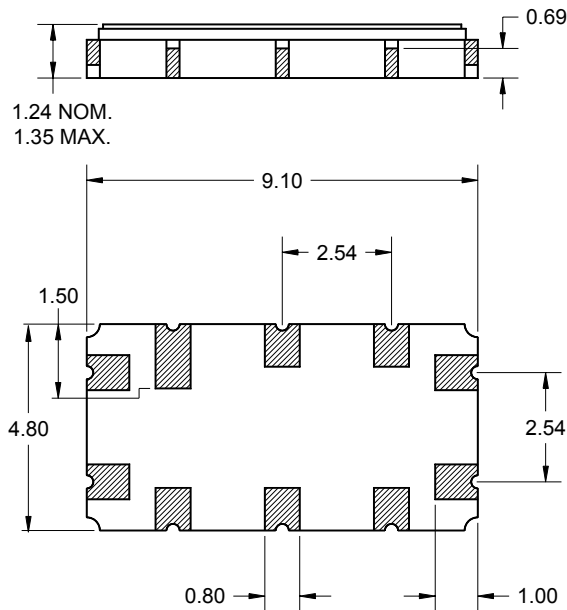

Dimensions shown are nominal in millimeters  
 All tolerances are  $\pm 0.15$ mm except overall  
 length and width  $+0.10$ mm/ $-0.10$ mm

Body:  $Al_2O_3$  ceramic  
 Lid: Kovar, Ni plated  
 Terminations: Au plating 0.5 - 1.0 $\mu$ m,  
 over a 2 - 6 $\mu$ m Ni plating

## Pin Configuration

Bottom View

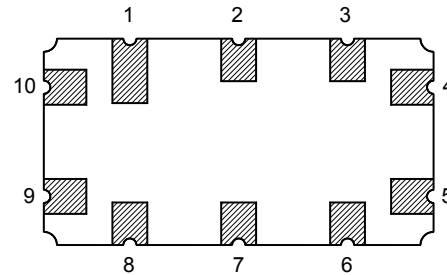

Pin No.	Description
4	Input
5	Input Return
9	Output
10	Output Return
1,2,3,6,7,8	Case Ground

# Preliminary Data Sheet

## Electrical Specifications <sup>(1)</sup>

Operating Temperature Range: <sup>(2)</sup> 0 to +70 °C

Parameter <sup>(3)</sup>	Minimum	Typical	Maximum	Unit
Center Frequency	349	350	351	MHz
Insertion Loss at 350 MHz <sup>(4)</sup>	-	9.8	13	dB
3 dB Bandwidth	2.6	3.0	-	MHz
Relative Attenuation <sup>(4)</sup>				
10.0 - 347.8 MHz	45	52	-	dB
347.0 - 347.8 MHz	27	28	-	dB
347.8 - 348.3 MHz	5	6	-	dB
351.7 - 352.2 MHz	5	6	-	dB
352.2 - 353.0 MHz	27	28	-	dB
353.0 - 1000 MHz	45	52	-	dB
Group Delay Variation				
349 - 351 MHz (any 500 kHz channel)	-	85	100	nsec
Optimal Source Impedance <sup>(5)</sup>	-	50	-	Ω
Optimal Load Impedance <sup>(5)</sup>	-	50	-	Ω

### Notes:

1. All specifications are based on the test circuit shown below
2. In production, devices will be tested at room temperature to a guardbanded specification to ensure electrical compliance over temperature
3. Electrical margin has been built into the design to account for the variations due to temperature drift and manufacturing tolerances
4. Reference to insertion loss at 350MHz
5. This is the optimum impedance in order to achieve the performance shown

### Test Circuit:

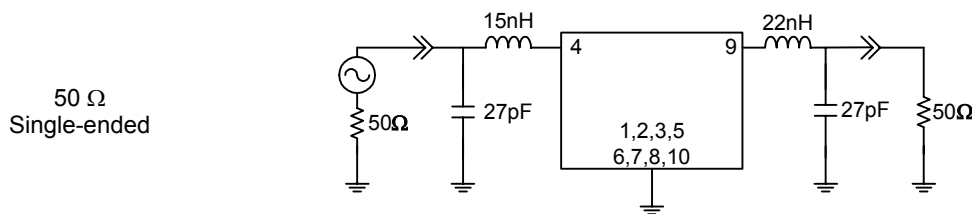

**Preliminary Data Sheet**

**Typical Performance (at +25°C)**

**Frequency Response**

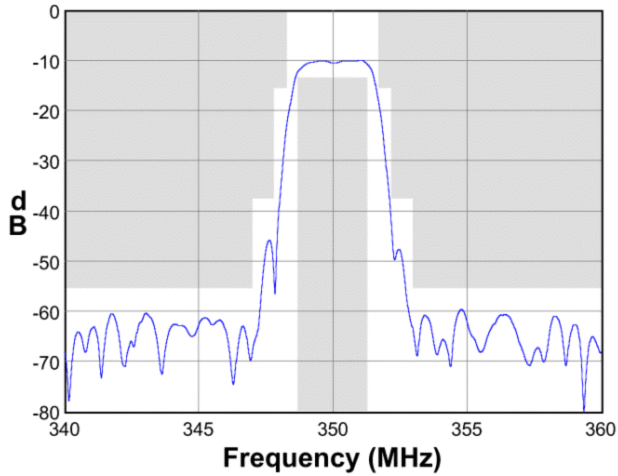

**Passband Response**

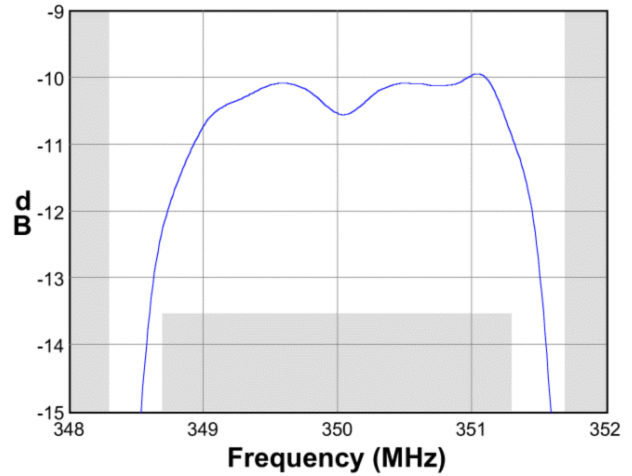

**Wideband Response**

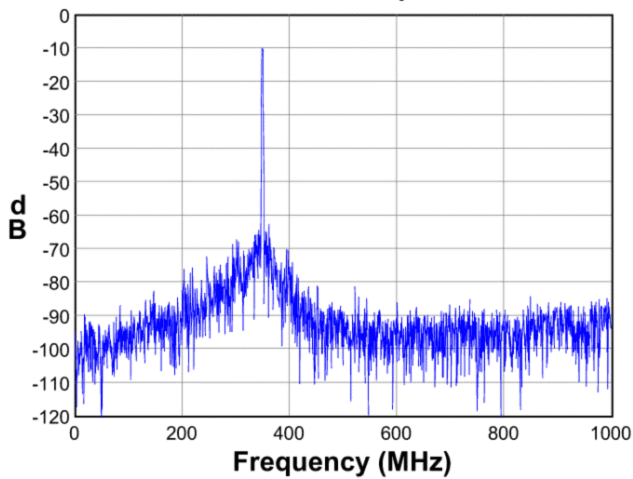

**Group Delay Variation**

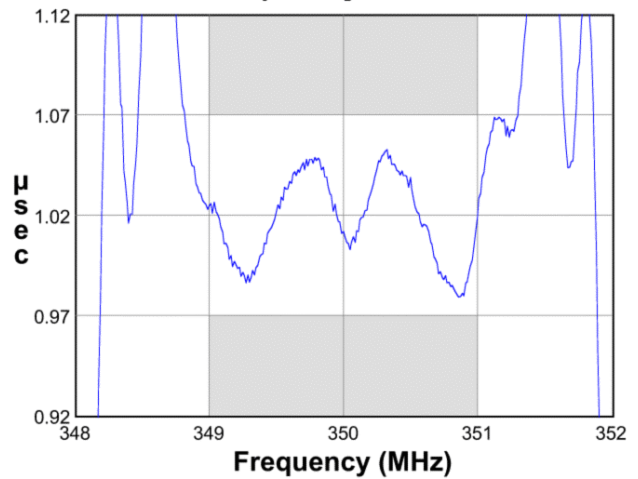

**Input Smith Chart**

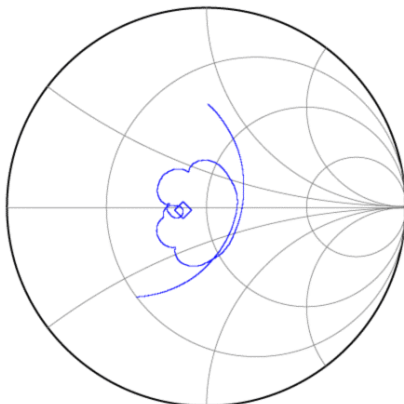

**Output Smith Chart**

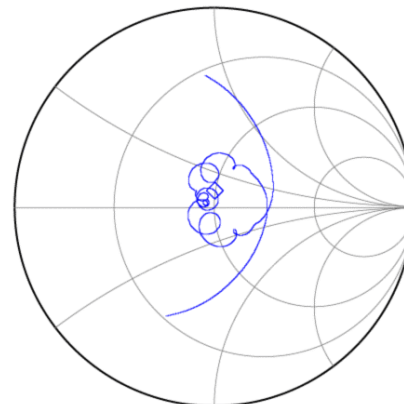

**Preliminary Data Sheet**

**Matching Schematics**

Actual matching values may vary due to PCB layout and parasitics

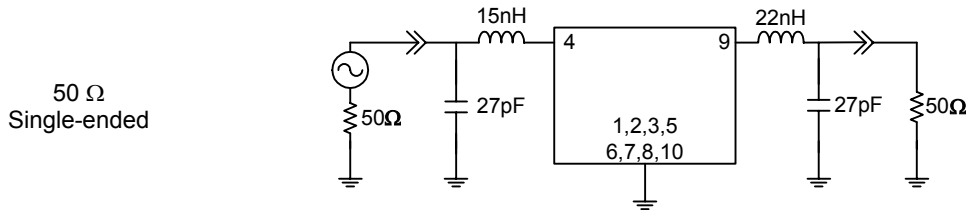

**Marking**

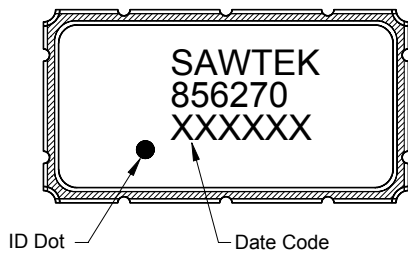

The date code consists of: day of the current year (Julian, 3 digits), last digit of the year (1 digit) and hour (2 digits)

**PCB Footprint**

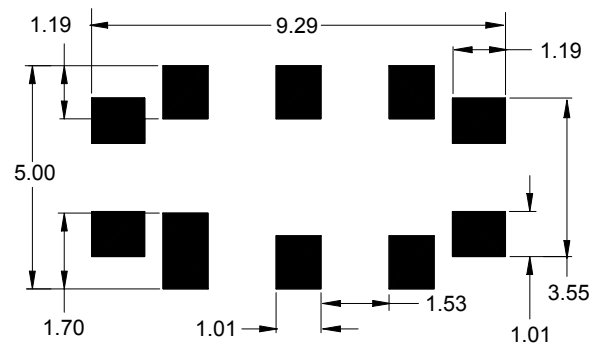

This footprint represents a recommendation only  
Dimensions shown are nominal in millimeters

**Tape and Reel**

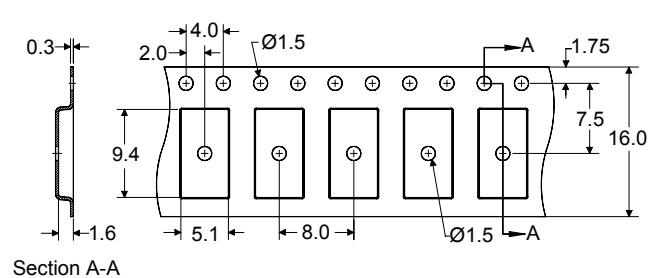
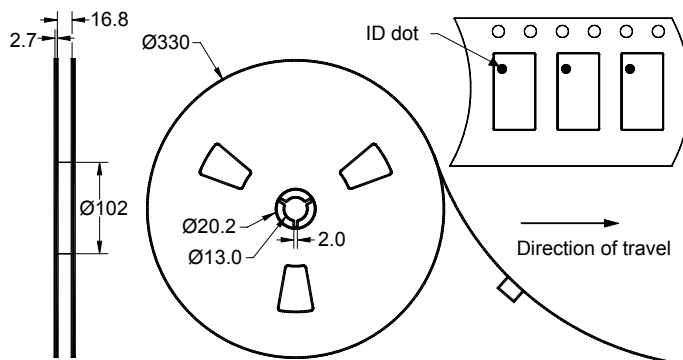

Dimensions shown are nominal in millimeters  
Packaging quantity: 4000 units/reel

# Preliminary Data Sheet

## Maximum Ratings

Parameter	Symbol	Minimum	Maximum	Unit
Operating Temperature Range	T	0	+70	°C
Storage Temperature Range	T <sub>stg</sub>	-40	+85	°C

### Warnings

- Electrostatic Sensitive Device (ESD) 
- Avoid ultrasonic exposure

## Links to Additional Technical Information

[PCB Layout Tips](#)

[Qualification Flowchart](#)

[Soldering Profile](#)

[S-Parameters](#)

[Other Technical Information](#)

Sawtek's liability is limited only to the Surface Acoustic Wave (SAW) component(s) described in this data sheet. Sawtek does not accept any liability for applications, processes, circuits or assemblies which are implemented using any Sawtek component described in this data sheet.

## Contact Information



PO Box 609501  
 Orlando, FL 32860-9501  
 USA

Phone: +1 (407) 886-8860  
 Fax: +1 (407) 886-7061  
 Email: [custservice@sawtek.com](mailto:custservice@sawtek.com)  
 Web: [www.sawtek.com](http://www.sawtek.com)

Or contact one of our worldwide network of [sales offices](#), [representatives](#) or [distributors](#)