

## Features

- Programmable output voltage to 20 volts
- Sink current capability of 1.0mA to 100mA
- Low dynamic impedance 0.15Ω typical
- Temperature compensated for operation over full rated operating temperature
- Equivalent full-range temperature coefficient of 50ppm/°C (Typical)
- Low output Noise voltage

## Ordering Information

Type NO.	Marking	Package Code
A431xM	A431□	TO-92M

□: Grade => B : ±0.5% , A : ±1%

## Outline Dimensions

unit : mm

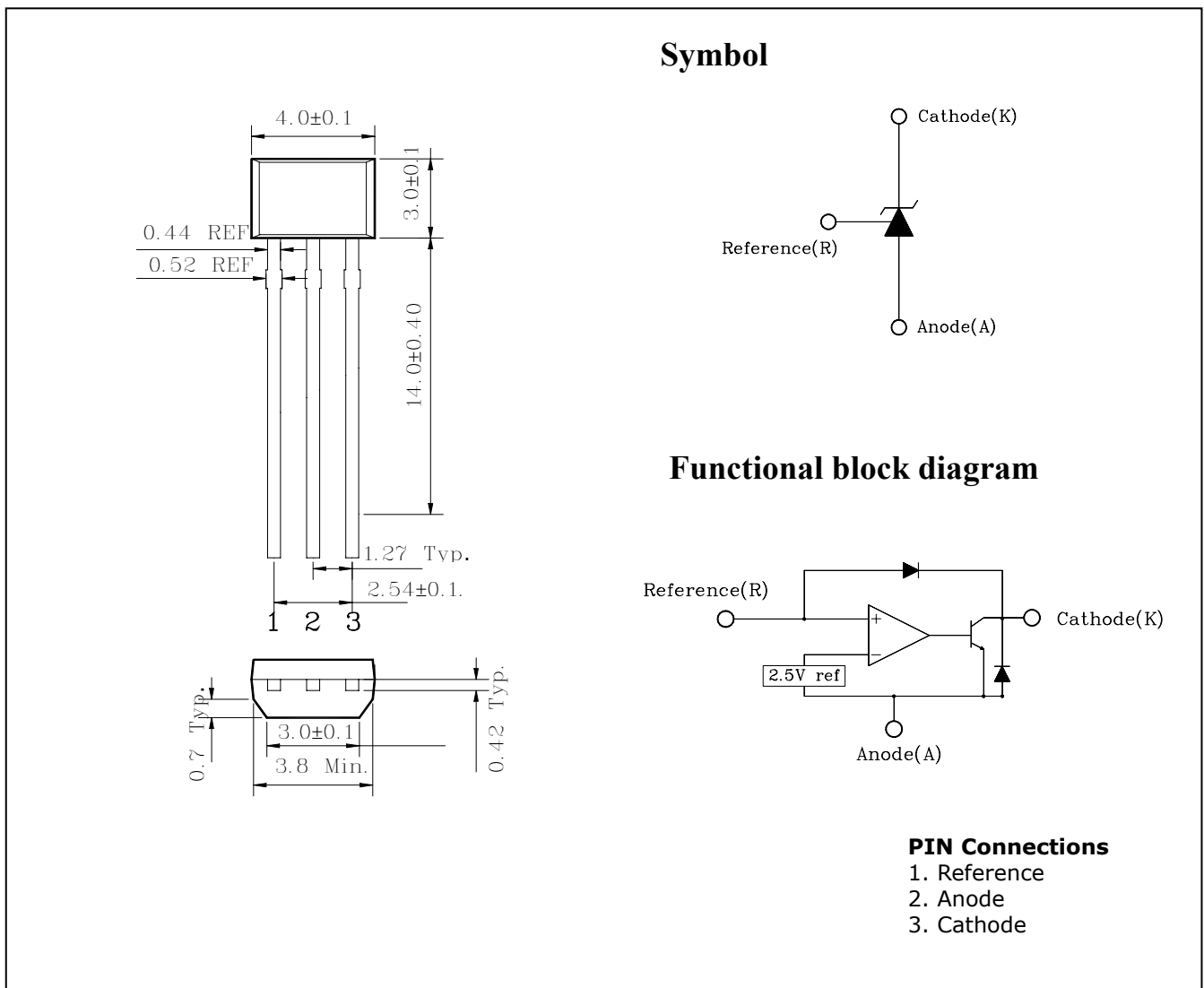

## Absolute maximum ratings

(Operating ambient temperature range applies unless other specified)

Parameter	Symbol	Ratings	Unit
Cathode to Anode voltage	$V_{KA}$	20	V
Cathode current range	$I_{KA}$	-100 ~ +150	mA
Reference input current range	$I_{ref}$	-0.05 ~ +10	mA
Power dissipation	$P_D$	500	mW
Operating temperature range	$T_{opr}$	-40 ~ +85	°C
Storage temperature range	$T_{stg}$	-65 ~ +150	°C

## Recommended operating conditions

Parameter	Symbol	Ratings		Unit
		Min.	Max.	
Cathode to Anode voltage	$V_{KA}$	$V_{ref}$	18	V
Cathode current range	$I_{KA}$	1.0	100	mA

## Electrical Characteristics

(Ambient temperature at 25°C, unless otherwise noted.)

Parameter	Symbol	Condition	Min.	Typ.	Max.	Unit
Reference input voltage (Fig. 1, Note 1)	$V_{ref}$	$V_{KA}=V_{ref}$ , $I_{KA}=10mA$	A431BM 2.482 A431AM 2.470	2.495	2.508 2.520	V
Deviation of reference input voltage Over temperature(Fig. 1, Note 1,2)	$\Delta V_{ref}$	$V_{KA}=V_{ref}$ , $I_{KA}=10mA$ @ $T_a=T_{LOW}$ to $T_{HIGH}$	-	7.0	30	mV
Ratio of change in reference input Voltage to the change in cathode Voltage(Fig. 2)	$\frac{\Delta V_{ref}}{\Delta V_{KA}}$	$I_{KA}=10mA$ $\Delta V_{KA}=10V-V_{ref}$ $\Delta V_{KA}=20V-10V$	-	1.2 0.7	2.7 2.0	mV/V
Reference input current(Fig. 2)	$I_{ref}$	$I_{KA}=10mA$ $R1=10K\Omega$ , $R2=\infty$	-	1.8	4.0	$\mu A$
Deviation of reference input current over temperature(Fig. 2)	$\Delta I_{ref}$	$I_{KA}=10mA$ $R1=10K\Omega$ , $R2=\infty$	-	0.4	2.5	$\mu A$
Minimum cathode current for Regulation(Fig. 1)	$I_{MIN}$	$V_{KA}=V_{ref}$	-	0.35	1.0	mA
Off-state cathode current(Fig. 3)	$I_{OFF}$	$V_{KA}=20V$ , $V_{ref}=0V$	-	2.7	1000	nA
Dynamic impedance(Fig. 1, Note 3)	$Z_{KA}$	$V_{KA}=V_{ref}$ , $f \leq 1.0KHz$ $I_{KA}=1.0mA-100mA$	-	0.14	0.5	$\Omega$

**Fig. 1**

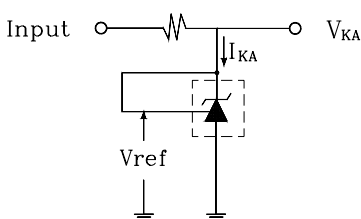

**Fig. 2**

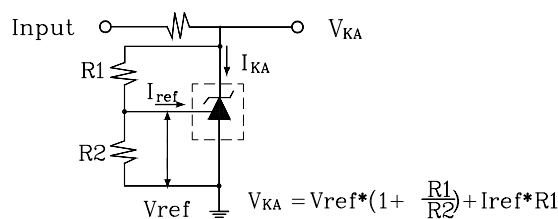

**Fig. 3**

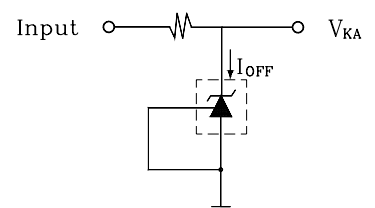

<Note 1> :  $T_{LOW}=-40^{\circ}C$ ,  $T_{HIGH}=+85^{\circ}C$  , <Note 2> :  $\Delta V_{ref}=V_{ref} Max. - V_{ref} Min.$  , <Note 3> :  $Z_{KA}=\Delta V_{KA}/\Delta I_{KA}$

Characteristic diagrams

Fig. 4  $I_{KA}$  vs.  $V_{KA}$

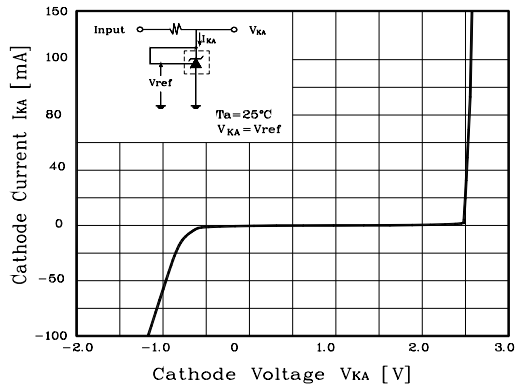

Fig. 5  $I_{MIN}$  vs.  $V_{KA}$

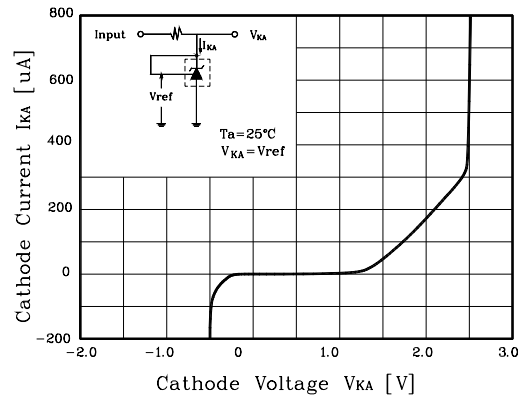

Fig. 6  $\Delta V_{ref}$  vs.  $T_a$

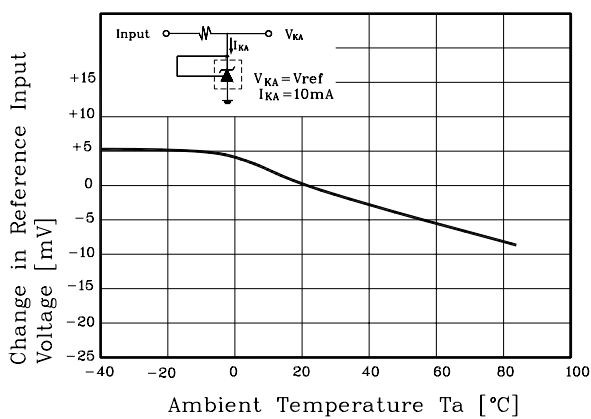

Fig. 7  $G_v$  vs. frequency

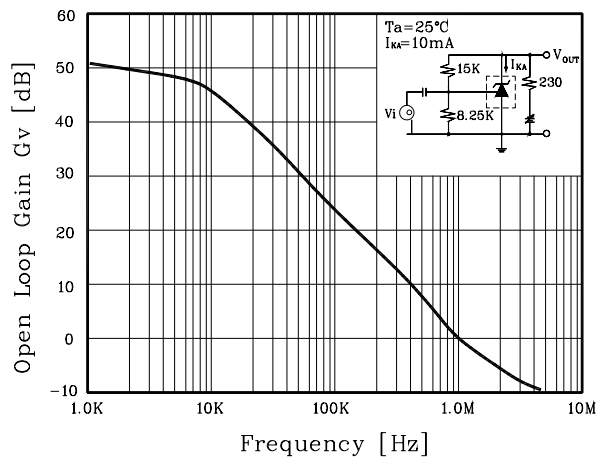
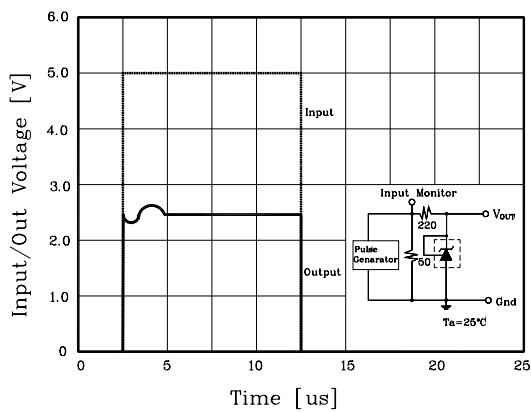

Fig. 8 Pulse response



**These AUK products are intended for usage in general electronic equipments(Office and communication equipment, measuring equipment, domestic electrification, etc.).**

**Please make sure that you consult with us before you use these AUK products in equipments which require high quality and/or reliability, and in equipments which could have major impact to the welfare of human life(atomic energy control, airplane, spaceship, traffic signal, combustion central, all types of safety device, etc.).**

**AUK cannot accept liability to any damage which may occur in case these AUK products were used in the mentioned equipments without prior consultation with AUK.**