

### General Description

The AAT3151 is a low noise, constant frequency charge pump DC/DC converter that uses a tri-mode load switch (1X), fractional (1.5X), and doubling (2X) conversion to maximize efficiency for white LED applications. The AAT3151 is capable of driving four white LEDs at a total of 120mA from a 2.7V to 5.5V input. The current sinks may be operated individually or in parallel for driving higher-current LEDs. A low external parts count (two 1 $\mu$ F flying capacitors and two small 1 $\mu$ F capacitors at  $V_{IN}$  and  $V_{OUT}$ ) makes the AAT3151 ideally suited for small battery-powered applications.

AnalogicTech's AS<sup>2</sup>Cwire™ (Advanced Simple Serial Control™) serial digital input is used to enable, disable, and set current for each LED with a 16-level logarithmic scale plus four low-current settings down to 50 $\mu$ A for optimized efficiency, with a low housekeeping current of only 50 $\mu$ A.

The charge pump output of the AAT3151 is equipped with built-in protection for  $V_{OUT}$ . Each current sink input has short-circuit and auto-disable to guard against LED failure conditions. Built-in soft-start circuitry prevents excessive inrush current during start-up. A low-current shutdown feature disconnects the load from  $V_{IN}$  and reduces quiescent current to less than 1 $\mu$ A.

The AAT3151 is available in a Pb-free, space-saving, thermally-enhanced, 12-pin 3x3mm TDFN package, or in the lower-profile STDFN package.

### Typical Application

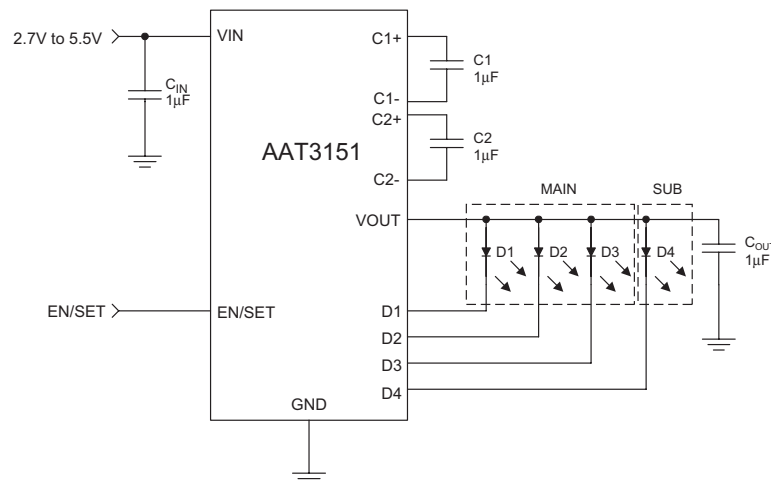

### Features

- $V_{IN}$  Range: 2.7V to 5.5V
- Fully Programmable Current with Single Wire
  - 16-Step Logarithmic Scale
  - 15/20/30mA Max Current
  - Four Low-Current Settings Down to 50 $\mu$ A
  - Low  $I_Q$  (50 $\mu$ A) for Low-Current Mode
- Tri-Mode 1X, 1.5X, and 2X Charge Pump for Maximum Efficiency and  $V_F$  Coverage
- Drives Four Channels of LEDs
- Individual Main/Sub-Group Control
- No Inductors, Low Noise Operation
- 1MHz Constant Switching Frequency
- Small Application Circuit
- Built-In Thermal Protection
- Built-In Auto-Disable for Short-Circuit
- Automatic Soft Start
- $I_Q < 1\mu$ A in Shutdown
- TDFN33-12 or STDFN33-12 Package

### Applications

- Color (RGB) Lighting
- Programmable Current Sinks
- White LED Backlighting
- White Photo Flash for Digital Still Cameras

### Pin Descriptions

Pin #	Symbol	Function
1	D4	Current sink input #4.
2	EN/SET	AS <sup>2</sup> Cwire serial interface control pin.
3	C1+	Flying capacitor 1 positive terminal. Connect a 1μF capacitor between C1+ and C1-.
4	C1-	Flying capacitor 1 negative terminal.
5	VOUT	Charge pump output to drive load circuit. Requires 1μF capacitor connected between this pin and ground.
6	C2+	Flying capacitor 2 positive terminal. Connect a 1μF capacitor between C2+ and C2-.
7	C2-	Flying capacitor 2 negative terminal.
8	VIN	Input power supply. Requires 1μF capacitor connected between this pin and ground.
9	GND	Ground.
10	D1	Current sink input #1.
11	D2	Current sink input #2.
12	D3	Current sink input #3.
EP		Exposed paddle (bottom). Connect to GND directly beneath package.

### Pin Configuration

**TDFN33-12/STDFN33-12  
(Top View)**

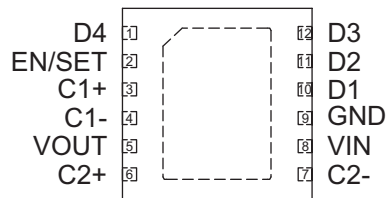

### Absolute Maximum Ratings<sup>1</sup>

Symbol	Description	Value	Units
$V_{IN}$	Input Voltage	-0.3 to 6	V
$V_{EN/SET}$	EN/SET to GND Voltage	-0.3 to $V_{IN} + 0.3$	V
$I_{OUT}^2$	Maximum DC Output Current	150	mA
$T_J$	Operating Junction Temperature Range	-40 to 150	°C
$T_{LEAD}$	Maximum Soldering Temperature (at leads, 10 sec)	300	°C

### Thermal Information<sup>3</sup>

Symbol	Description	Value	Units
$P_D$	Maximum Power Dissipation <sup>4</sup>	2.0	W
$\theta_{JA}$	Maximum Thermal Resistance	50	°C/W

1. Stresses above those listed in Absolute Maximum Ratings may cause permanent damage to the device. Functional operation at conditions other than the operating conditions specified is not implied. Only one Absolute Maximum Rating should be applied at any one time.
2. Based on long-term current density limitation.
3. Mounted on an FR4 board.
4. Derate 20mW/°C above 25°C.

# AAT3151

## High Efficiency 1X/1.5X/2X Charge Pump For White LED Applications

### Electrical Characteristics<sup>1</sup>

$C_{IN} = C_{OUT} = C_1 = C_2 = 1.0\mu\text{F}$ ;  $T_A = -40^\circ\text{C}$  to  $+85^\circ\text{C}$ , unless otherwise noted.  
Typical values are  $T_A = 25^\circ\text{C}$ ,  $V_{IN} = 3.5\text{V}$ .

Symbol	Description	Conditions	Min	Typ	Max	Units
<b>Input Power Supply</b>						
$V_{IN}$	Operation Range		2.7		5.5	V
$I_{CC}$	Operating Current	1X Mode, $3.0 \leq V_{IN} \leq 5.5$ , Active, No Load Current		0.3	1	mA
		1.5X Mode, $3.0 \leq V_{IN} \leq 5.5$ , Active, No Load Current		1	3	
		2X Mode, $3.0 \leq V_{IN} \leq 5.5$ , Active, No Load Current		2.0	3.7	
		50 $\mu\text{A}$ Setting, 1X Mode		50		$\mu\text{A}$
$I_{SHDN}$	Shutdown Current	EN/SET = 0			1	$\mu\text{A}$
$I_{DX}$	$I_{SINK}$ Current Accuracy <sup>2</sup>	$I_{SET} = 30\text{mA}$ , $T_A = 25^\circ\text{C}$	27	30	33	mA
$I_{(D-Match)}$	Current Matching Between Any Two Current Sink Inputs <sup>3,4</sup>	$V_F:D1:D4 = 3.6\text{V}$		0.5		%
$V_{TH}$	1X to 1.5X or 1.5X to 2X Transition Threshold at Any $I_{SINK}$ Pin	$I_{SET} = 20\text{mA}$		150		mV
<b>Charge Pump Section</b>						
$T_{SS}$	Soft-Start Time			100		$\mu\text{s}$
$F_{CLK}$	Clock Frequency			1000		kHz
<b>EN/SET</b>						
$V_{IL}$	Enable Threshold Low	$V_{IN} = 2.7\text{V}$			0.4	V
$V_{IH}$	Enable Threshold High	$V_{IN} = 5.5\text{V}$	1.4			V
$T_{EN/SET\_LO}$	EN/SET Low Time		0.3		75	$\mu\text{s}$
$T_{EN/SET\_HL\_MIN}$	Minimum EN/SET High Time			50		ns
$T_{EN/SET\_HL\_MAX}$	Maximum EN/SET High Time				75	$\mu\text{s}$
$T_{OFF}$	EN/SET Off Timeout <sup>5</sup>				500	$\mu\text{s}$
$T_{LAT}$	EN/SET Latch Timeout <sup>6</sup>				500	$\mu\text{s}$
$I_{EN/SET}$	EN/SET Input Leakage		-1		1	$\mu\text{A}$

1. The AAT3151 is guaranteed to meet performance specifications over the  $-40^\circ\text{C}$  to  $+85^\circ\text{C}$  operating temperature range and is assured by design, characterization, and correlation with statistical process controls.

2. Determined by the average of all active channels.

3. Current matching is defined as the deviation of any sink current at  $I_{OUT} = 20\text{mA}$  and  $2\text{mA}$ .

4. Specification applies only to the tri-mode charge pump.

5. The EN/SET pin must remain logic low (less than  $V_{IL}$ ) for the duration of longer than  $500\mu\text{s}$  to guarantee the off timeout.

6. The EN/SET pin must remain logic high (greater than  $V_{IH}$ ) for the duration of longer than  $500\mu\text{s}$  to guarantee the latch timeout.

# AAT3151

## High Efficiency 1X/1.5X/2X Charge Pump For White LED Applications

### Typical Characteristics

**Efficiency vs. Supply Voltage**

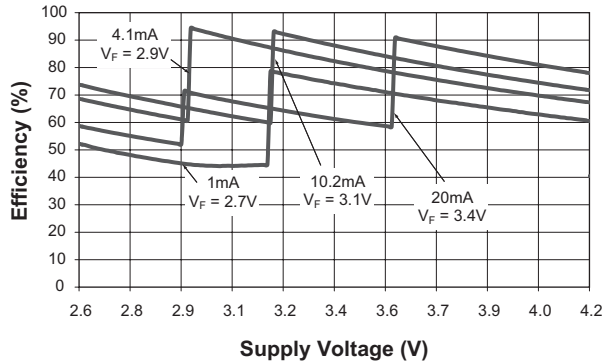

**Turn-On to 1X Mode**  
( $V_{IN} = 4.2V$ ; 20mA Load)

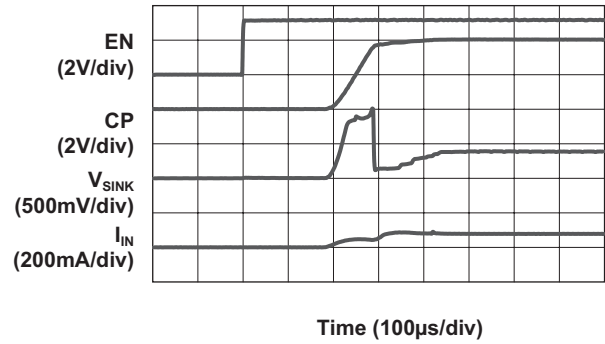

**Turn-On to 1.5X Mode**  
( $V_{IN} = 3.5V$ ; 20mA Load)

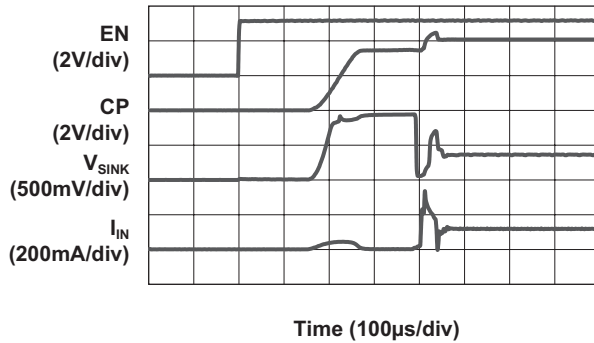

**Turn-On to 2X Mode**  
( $V_{IN} = 2.8V$ ; 20mA Load)

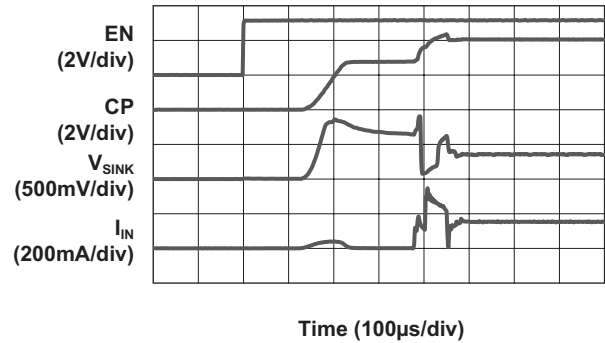

**Turn-Off from 1.5X Mode**  
( $V_{IN} = 3.5V$ ; 20mA Load)

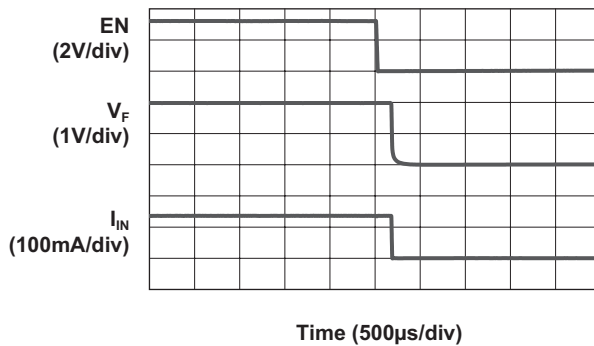

**Current Matching vs. Temperature**

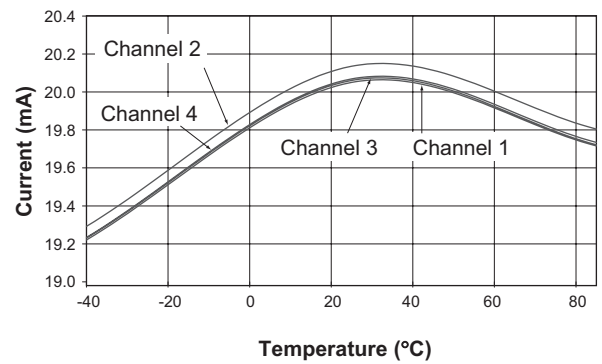

# AAT3151

## High Efficiency 1X/1.5X/2X Charge Pump For White LED Applications

### Typical Characteristics

**Load Characteristics**  
( $V_{IN} = 3.7V$ ; 1.5X Mode; 15mA Load)

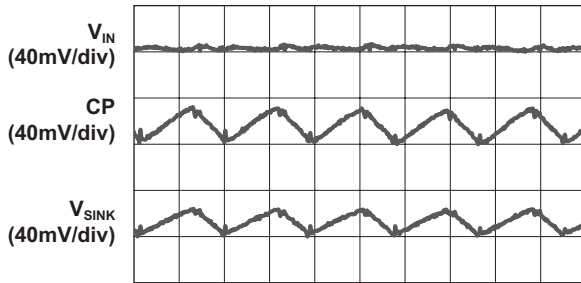

Time (500ns/div)

**Load Characteristics**  
( $V_{IN} = 2.7V$ ; 2X Mode; 15mA Load)

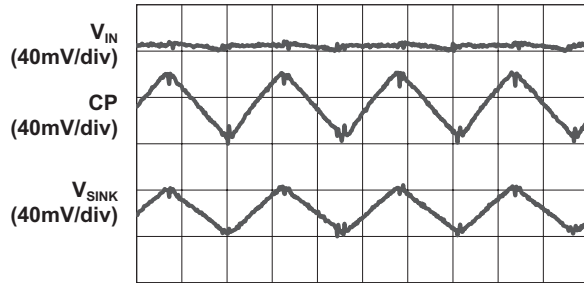

Time (500ns/div)

**Load Characteristics**  
( $V_{IN} = 3.9V$ ; 1.5X Mode; 20mA Load)

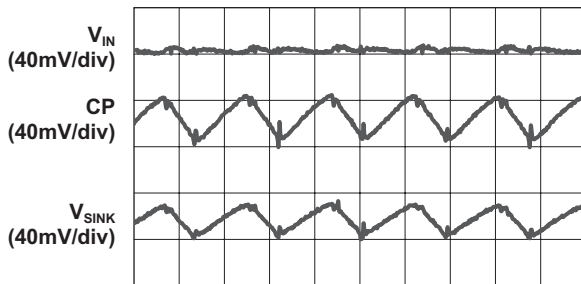

Time (500ns/div)

**Load Characteristics**  
( $V_{IN} = 2.9V$ ; 2X Mode; 20mA Load)

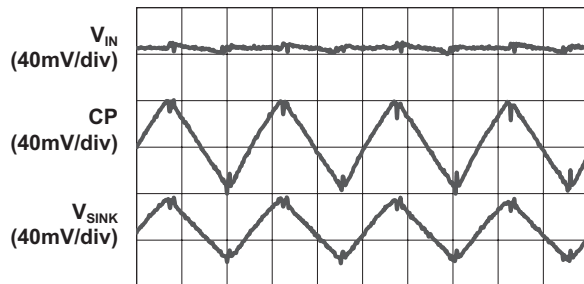

Time (500ns/div)

**Load Characteristics**  
( $V_{IN} = 4.2V$ ; 1.5X Mode; 30mA Load)

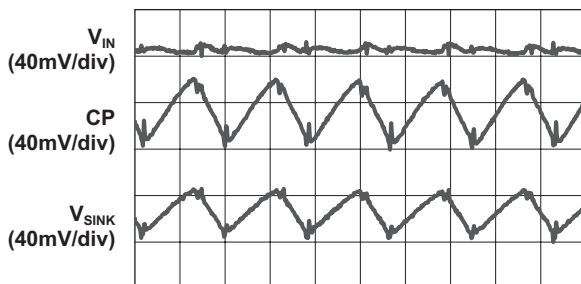

Time (500ns/div)

**Load Characteristics**  
( $V_{IN} = 3.2V$ ; 2X Mode; 30mA Load)

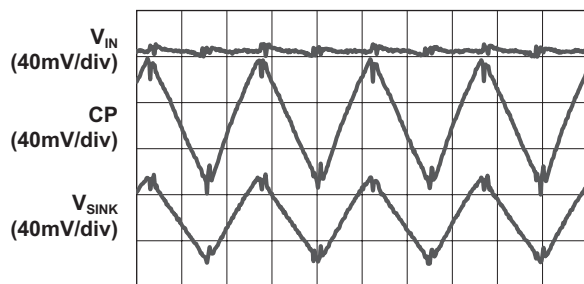

Time (500ns/div)

# AAT3151

## High Efficiency 1X/1.5X/2X Charge Pump For White LED Applications

### Typical Characteristics

**EN/SET Latch Timeout vs. Input Voltage**

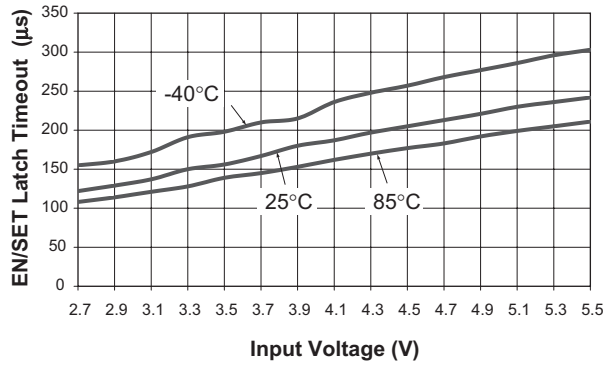

**EN/SET Off Timeout vs. Input Voltage**

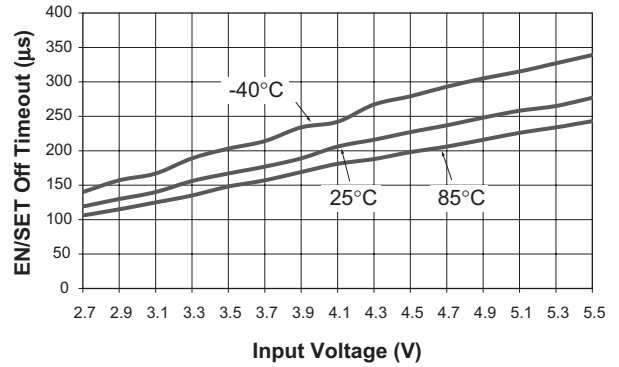

**Input Ripple vs. Input Voltage**

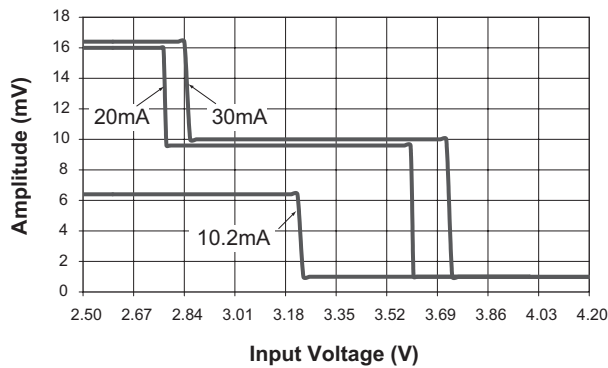

**Enable Threshold High vs. Input Voltage**

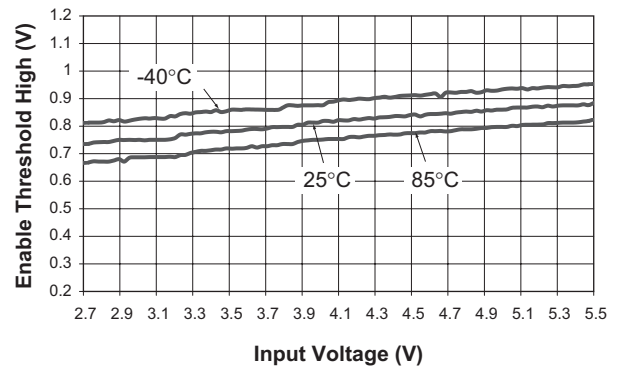

**Enable Threshold Low vs. Input Voltage**

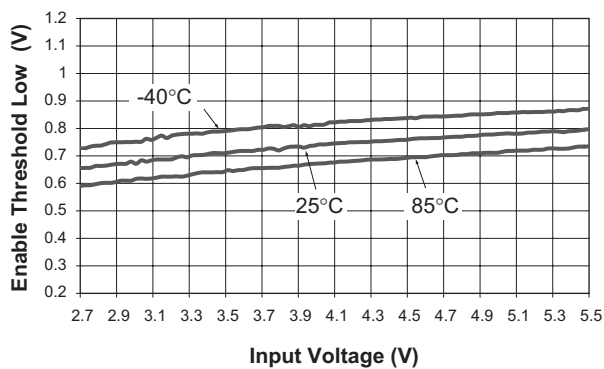

# AAT3151

## High Efficiency 1X/1.5X/2X Charge Pump For White LED Applications

### Functional Block Diagram

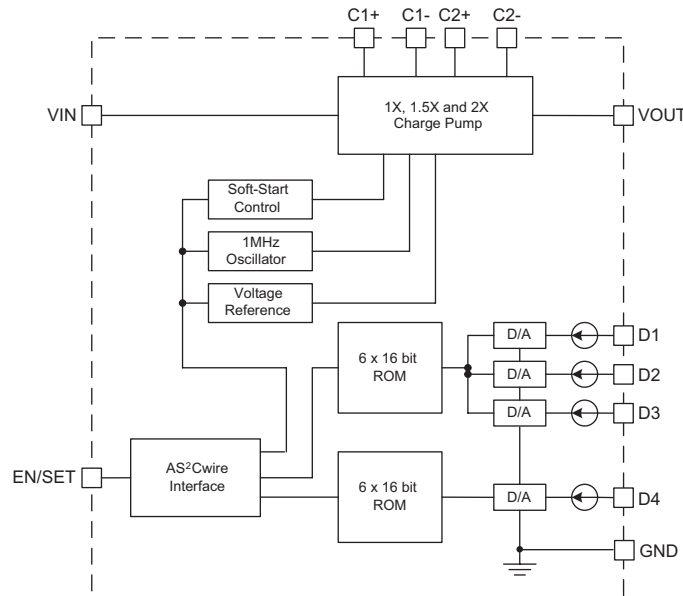

### Functional Description

The AAT3151 is a tri-mode load switch (1X) and high efficiency (1.5X or 2X) charge pump device intended for white LED backlight applications. To maximize power conversion efficiency, an internal sensing circuit monitors the voltage required on each constant current sink input and sets the load switch and charge pump modes based on the input battery voltage and the current sink input voltage. As the battery discharges over time, the AAT3151 charge pump is enabled when any of the four current sinks near dropout. The charge pump initially starts in 1.5X mode. If the charge pump output drops enough for any current sink to become close to dropout, the charge pump will automatically transition to 2X mode.

The AAT3151 requires only four external components: two 1 $\mu$ F ceramic capacitors for the charge pump flying capacitors ( $C_1$  and  $C_2$ ), one 1 $\mu$ F ceramic input capacitor ( $C_{IN}$ ), and one 1 $\mu$ F ceramic charge pump output capacitor ( $C_{OUT}$ ).

The AAT3151 constant current sinks can drive four individual LEDs with a maximum current of 30mA

per channel. The AS<sup>2</sup>Cwire serial interface enables the AAT3151 and sets the constant current sink magnitudes. AS<sup>2</sup>Cwire addressing allows the LED main channels D1-D3 to be controlled independently from the LED sub-channel D4.

### Constant Current Output Level Settings

The constant current level for the LED channels is set via the AS<sup>2</sup>Cwire serial interface according to a logarithmic scale. In this manner, LED brightness appears to change linearly when the settings in the scale are traversed. Because the inputs D1 to D4 are true independent constant current sinks, the voltage observed on any single given input will be determined by the difference between  $V_{OUT}$  and the actual forward voltage ( $V_F$ ) of the LED being driven.

Since the constant current levels for the AAT3151 are programmable, no PWM (pulse width modulation) or additional control circuitry are needed to control LED brightness. This feature greatly reduces the burden on a microcontroller or system IC to manage LED or display brightness, allowing the user to "set it and forget it." With its high-speed seri-



# AAT3151

## High Efficiency 1X/1.5X/2X Charge Pump For White LED Applications

---

al interface (>1MHz data rate), the LED current drive can be changed successively to brighten or dim LEDs in smooth transitions (e.g., to fade out) or in abrupt steps, giving the user complete programmability and real-time control of LED brightness.

For each Max Current scale, there are 16 current level settings separated from one another by approximately 1dB. Code 1 is full-scale current and Code 15 is full-scale current attenuated by roughly 14dB. Code 16 is reserved as a "no current" setting (see Table 1).

The AAT3151 has an additional Low Current mode with reduced quiescent current. This mode is especially useful for low-current applications where a continuous, low-current state is maintained. The reduction in quiescent current significantly reduces the impact due to maintaining a continuous back-lighting state.

Data	20mA Max <sup>1</sup> I <sub>OUT</sub> (mA)	30mA Max I <sub>OUT</sub> (mA)	15mA Max I <sub>OUT</sub> (mA)
1	20.0	30.0	15.0
2	17.8	26.7	13.3
3	15.9	23.8	11.9
4	14.3	21.4	10.7
5	12.7	19.0	9.5
6	11.1	16.7	8.3
7	10.2	15.2	7.6
8	8.9	13.3	6.7
9	7.9	11.9	6.0
10	7.0	10.5	5.2
11	6.3	9.5	4.8
12	5.7	8.6	4.3
13	5.1	7.6	3.8
14	4.4	6.7	3.3
15	4.1	6.2	3.1
16	0.0	0.0	0.0

**Table 1: Constant Current Programming Levels (mA)<sup>2</sup>.**

### AS<sup>2</sup>Cwire Serial Interface

The AS<sup>2</sup>Cwire single wire interface is used to set the possible combinations of current levels and LED channel states. AS<sup>2</sup>Cwire has addressing capability for multiple data registers. With multiple data registers, the AAT3151 main and sub-channels can be programmed together or independently from one another.

AS<sup>2</sup>Cwire relies on the number of rising edges of the EN/SET pin to address and load the registers. AS<sup>2</sup>Cwire latches data or address after the EN/SET pin has been held high for time T<sub>LAT</sub>. Address or data is differentiated by the number of EN/SET rising edges. Since the data registers are 4 bits each, the differentiating number of pulses is 2<sup>4</sup> or 16, so that Address 1 is signified by 17 rising edges, Address 2 by 18 rising edges, and so forth. Data is set to any number of rising edges between 1 and including 16. A typical write protocol is a burst of EN/SET rising edges, signifying a particular address, followed by a pause with EN/SET held high for the T<sub>LAT</sub> timeout period, a burst of rising edges signifying data, and a T<sub>LAT</sub> timeout for the data registers. Once an address is set, then multiple writes to the corresponding data register are allowed.

When EN/SET is held low for an amount of time greater than T<sub>OFF</sub>, the AAT3151 enters shutdown mode and draws less than 1μA from the supply. Address 1 is the default address on the first rising edge after the AAT3151 has been disabled. Whenever shutdown mode is entered, all registers are reset to 1.

---

1. The device defaults to the 20mA Max scale. Use the Max Current Register to change the Max Scale.  
2. There is an additional Low Current mode with currents down to 50μA. See the Low Current Register Settings section.

# AAT3151

## High Efficiency 1X/1.5X/2X Charge Pump For White LED Applications

### AS<sup>2</sup>Cwire Serial Interface Timing

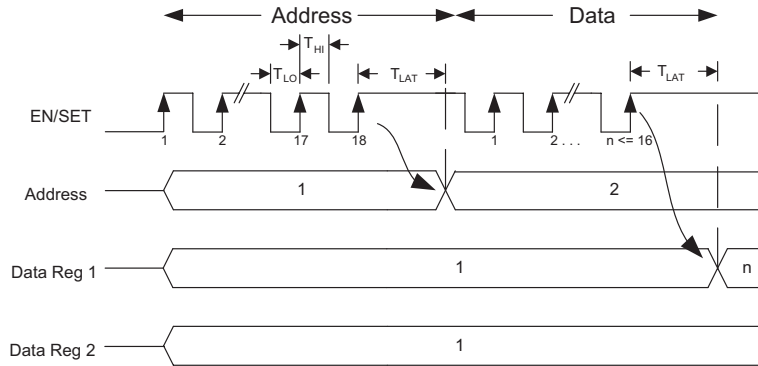

### AS<sup>2</sup>Cwire Addressing

Five addresses are available to enable all of the part's functionality. Two 4-bit registers control the main and sub-channel, giving 16 settings for each. The main and sub-channel are programmed to the same constant current level by using Address 1. Use Addresses 2 and 3 to program the main and sub-channel independently. Use Address 4 to program the Max Current register, which sets the Max Current scale. Address 5 programs the Low Current register. The Low Current register controls the efficient Low Current mode.

When the Max Current register is programmed to 1, 2, or 3, changing the data for Addresses 1-3 will result in the corresponding values found in the Constant Current Programming Levels table. When the Max Current register is programmed to 4, the part is programmed to operate in Low Current mode and the Data for Addresses 1-3 is irrelevant. In Low Current mode, the Low Current register takes precedence. See Table 2 for the current level settings and main/sub-configurations that result.

Address	EN/SET Edges	Addressed Register
1	17	1&2: D1-D4 Current
2	18	1: D1-D3 Current
3	19	2: D4 Current
4	20	3: Max Current
5	21	4: Low Current

**Table 2: Low Current Register Settings.**

### Max Current and Low Current Registers

Use the Max Current and Low Current registers to program constant current settings outside of the 20mA Max scale. By default (without changing the Max Current register), the AAT3151 operates in the 20mA Max scale (see Constant Current Programming Levels). For example, to change to the 30mA Max scale, address the Max Current register with 20 rising edges and pause for T<sub>LAT</sub>. Program the Max Current register with 2 rising edges and pause for T<sub>LAT</sub>. The part will next operate in the same Data row, but for the setting found in the 30mA Max column. Next, to change to a different setting on the 30mA Max scale, address the D1-D4 register with 17 rising edges. Program the new constant current level with 1-16 rising edges. The part will update to the new Data setting according to the Constant Current Programming Levels table.

The AAT3151 has a distinct Low Current mode with ultra-low quiescent current. For drive currents of 2mA or less, the part operates with significantly reduced quiescent current. This is particularly useful for applications requiring an "always on" condition, such as transmissive displays. As an example, to change to Low Current mode, address the Max Current register with 20 rising edges and pause for T<sub>LAT</sub>. Program the Max Current register with 4 rising edges and pause for T<sub>LAT</sub>. Address the Low Current register with 21 rising edges and pause for T<sub>LAT</sub>. Program the Low Current register with 1-16 rising edges. The part will update to the new Low Current mode setting and operate with significantly reduced quiescent current.

# AAT3151

## High Efficiency 1X/1.5X/2X Charge Pump For White LED Applications

Data	Max Current
1	20mA Max Scale
2	30mA Max Scale
3	15mA Max Scale
4	Low Current Mode <sup>1</sup>

**Table 3: Max Current Register Settings—  
Address 4.**

Data	D1-D3 (mA)	D4 (mA)
1	0	0
2	0	0
3	0	0
4	0	0
5	0	0.05
6	0	0.5
7	0	1
8	0	2
9	0.05	0
10	0.5	0
11	1	0
12	2	0
13	0.05	0.05
14	0.5	0.5
15	1	1
16	2	2

**Table 4: Low Current Register Settings—  
Address 5.**

### Disabled Current Sinks

Current sink inputs that are not used should be disabled. To disable and properly terminate unused current sink inputs, they must be tied to  $V_{OUT}$ . If left unconnected or terminated to ground, the part will be forced to operate in 2X charge pump mode.

Properly terminating unused current sink inputs is important to prevent the charge pump modes from prematurely activating. When properly terminated, only a small sense current flows for each disabled channel. The sense current for each disabled channel is 120 $\mu$ A.

The AAT3151 is also equipped with an "auto-disable" feature to protect against an LED failure condition.

### Thermal Protection

The AAT3151 has a thermal protection circuit that will shut down the charge pump if the die temperature rises above the thermal limit, as is the case during a short-circuit of the VOUT pin.

## Applications Information

### LED Selection

The AAT3151 is specifically intended for driving white LEDs. However, the device design will allow the AAT3151 to drive most types of LEDs with forward voltage specifications ranging from 2.0V to 4.3V. LED applications may include main and sub-LCD display backlighting, camera photo-flash applications, color (RGB) LEDs, infrared (IR) diodes for remotes, and other loads benefiting from a regulated output current generated from a varying input voltage. Since the D1 to D4 constant current sinks are matched with negligible voltage dependence, the LED brightness will be matched regardless of the specific LED forward voltage ( $V_F$ ) levels.

In some instances (e.g., in high luminous output applications such as photo flash), it may be necessary to drive high- $V_F$  type LEDs. The low dropout current sinks in the AAT3151 make it capable of driving LEDs with forward voltages as high as 4.3V at full current from an input supply as low as 3.0V. Current sinks can be paralleled to drive high-current LEDs without complication.

### Device Switching Noise Performance

The AAT3151 operates at a fixed frequency of approximately 1MHz to control noise and limit harmonics that can interfere with the RF operation of cellular telephone handsets or other communication devices. Back-injected noise appearing on the input pin of the charge pump is 20mV peak-to-peak, typically ten times less than inductor-based

1. Low Current mode requires the Max Current register to be set to Low Current Mode. Low Current mode is unaffected by the settings for Addresses 1-3.

# AAT3151

## High Efficiency 1X/1.5X/2X Charge Pump For White LED Applications

---

DC/DC boost converter white LED backlight solutions. The AAT3151 soft-start feature prevents noise transient effects associated with inrush currents during start-up of the charge pump circuit.

### Power Efficiency and Device Evaluation

The charge pump efficiency discussion in the following sections only accounts for the efficiency of the charge pump section itself. Due to the unique circuit architecture and design of the AAT3151, it is very difficult to measure efficiency in terms of a percent value comparing input power over output power.

Since the AAT3151 inputs are pure constant current sinks and typically drive individual loads, it is difficult to measure the output voltage for a given input (D1 to D4) to derive an overall output power measurement. For any given application, white LED forward voltage levels can differ, yet the load drive current will be maintained as a constant.

This makes quantifying output power a difficult task when taken in the context of comparing to other white LED driver circuit topologies. A better way to quantify total device efficiency is to observe the total input power to the device for a given LED current drive level. The best white LED driver for a given application should be based on trade-offs of size, external component count, reliability, operating range, and total energy usage...*not just % efficiency.*

The AAT3151 efficiency may be quantified under very specific conditions and is dependent upon the input voltage versus the output voltage seen across the loads applied to inputs D1 through D4 for a given constant current setting. Depending on the combination of  $V_{IN}$  and voltages sensed at the current sinks, the device will operate in load switch mode. When any one of the voltages sensed at the current sinks nears dropout, the device will operate in 1.5X or 2X charge pump mode. Each of these modes will yield different efficiency values. Refer to the following two sections for explanations for each operational mode.

### Load Switch Mode Efficiency

The AAT3151 load switch mode is operational at all times and functions alone to enhance device power conversion efficiency when  $V_{IN}$  is greater than the voltage across the load. When in load switch mode, the voltage conversion efficiency is defined as output power divided by input power:

$$\eta = \frac{P_{OUT}}{P_{IN}}$$

The expression to define the ideal efficiency ( $\eta$ ) can be rewritten as:

$$\eta = \frac{P_{OUT}}{P_{IN}} = \frac{V_{OUT} \cdot I_{OUT}}{V_{IN} \cdot I_{OUT}} = \frac{V_{OUT}}{V_{IN}}$$

-or-

$$\eta(\%) = 100 \left( \frac{V_{OUT}}{V_{IN}} \right)$$

### Charge Pump Section Efficiency

The AAT3151 contains a fractional charge pump that will boost the input supply voltage when  $V_{IN}$  is less than the voltage required on the constant current sink inputs. The efficiency ( $\eta$ ) can be simply defined as a linear voltage regulator with an effective output voltage that is equal to one and one half or two times the input voltage. Efficiency ( $\eta$ ) for an ideal 1.5X charge pump can typically be expressed as the output power divided by the input power.

$$\eta = \frac{P_{OUT}}{P_{IN}}$$

In addition, with an ideal 1.5X charge pump, the output current may be expressed as 2/3 of the

# AAT3151

## High Efficiency 1X/1.5X/2X Charge Pump For White LED Applications

---

input current. The expression to define the ideal efficiency ( $\eta$ ) can be rewritten as:

$$\eta = \frac{P_{OUT}}{P_{IN}} = \frac{V_{OUT} \cdot I_{OUT}}{V_{IN} \cdot 1.5I_{OUT}} = \frac{V_{OUT}}{1.5V_{IN}}$$

-or-

$$\eta(\%) = 100 \left( \frac{V_{OUT}}{1.5V_{IN}} \right)$$

### Capacitor Selection

Careful selection of the four external capacitors  $C_{IN}$ ,  $C_1$ ,  $C_2$ , and  $C_{OUT}$  is important because they will affect turn-on time, output ripple, and transient performance. Optimum performance will be obtained when low equivalent series resistance (ESR) ceramic capacitors are used. In general, low ESR may be defined as less than 100m $\Omega$ . A value of 1 $\mu$ F for all four capacitors is a good starting point when choosing capacitors. If the constant current sinks are only programmed for light current levels, then the capacitor size may be decreased.

### Capacitor Characteristics

Ceramic composition capacitors are highly recommended over all other types of capacitors for use with the AAT3151. Ceramic capacitors offer many advantages over their tantalum and aluminum electrolytic counterparts. A ceramic capacitor has very low ESR, is lowest cost, has a smaller PCB foot-

print, and is non-polarized. Low ESR ceramic capacitors help maximize charge pump transient response. Since ceramic capacitors are non-polarized, they are not prone to incorrect connection damage.

### Equivalent Series Resistance

ESR is an important characteristic to consider when selecting a capacitor. ESR is a resistance internal to a capacitor that is caused by the leads, internal connections, size or area, material composition, and ambient temperature. Capacitor ESR is typically measured in milliohms for ceramic capacitors and can range to more than several ohms for tantalum or aluminum electrolytic capacitors.

### Ceramic Capacitor Materials

Ceramic capacitors less than 0.1 $\mu$ F are typically made from NPO or C0G materials. NPO and C0G materials generally have tight tolerance and are very stable over temperature. Larger capacitor values are usually composed of X7R, X5R, Z5U, or Y5V dielectric materials. Large ceramic capacitors (i.e., greater than 2.2 $\mu$ F) are often available in low-cost Y5V and Z5U dielectrics, but capacitors greater than 1 $\mu$ F are not typically required for AAT3151 applications.

Capacitor area is another contributor to ESR. Capacitors that are physically large will have a lower ESR when compared to an equivalent material smaller capacitor. These larger devices can improve circuit transient response when compared to an equal value capacitor in a smaller package size.

### Ordering Information

Package	Marking <sup>1</sup>	Part Number (Tape and Reel) <sup>2</sup>
TDFN33-12	NLXY	<b>AAT3151IWP-T1</b>
STDFN33-12	URXY	<b>AAT3151IFP-T1</b>



All AnalogicTech products are offered in Pb-free packaging. The term “Pb-free” means semiconductor products that are in compliance with current RoHS standards, including the requirement that lead not exceed 0.1% by weight in homogeneous materials. For more information, please visit our website at <http://www.analogictech.com/pbfree>.

### Package Information

#### TDFN33-12

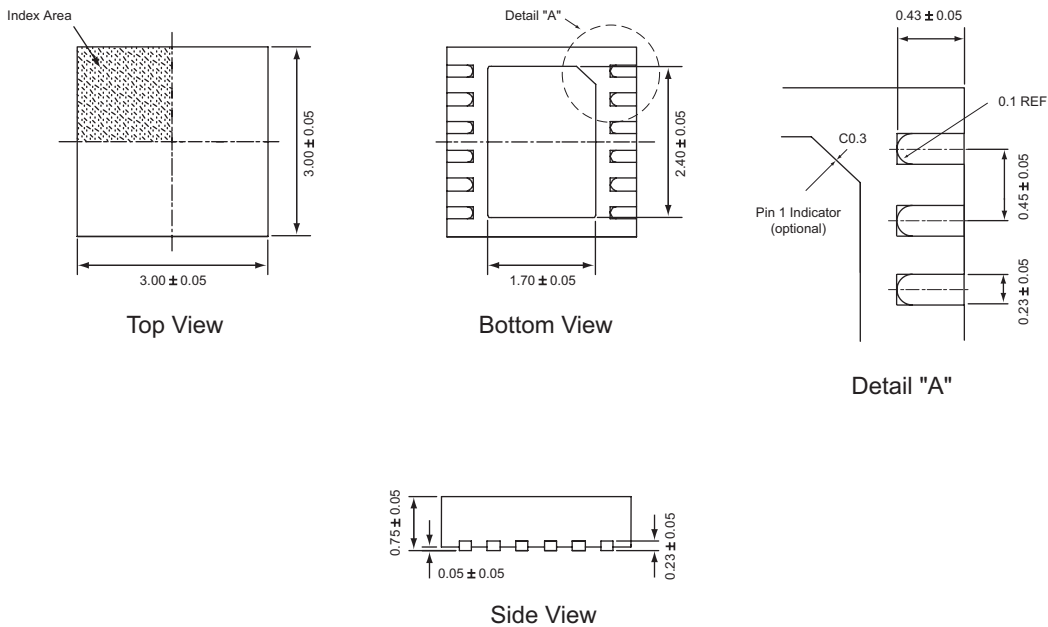

All dimensions in millimeters.

1. XY = assembly and date code.
2. Sample stock is generally held on part numbers listed in **BOLD**.
3. The leadless package family, which includes QFN, TQFN, DFN, TDFN and STDFN, has exposed copper (unplated) at the end of the lead terminals due to the manufacturing process. A solder fillet at the exposed copper edge cannot be guaranteed and is not required to ensure a proper bottom solder connection.

### STDFN33-12

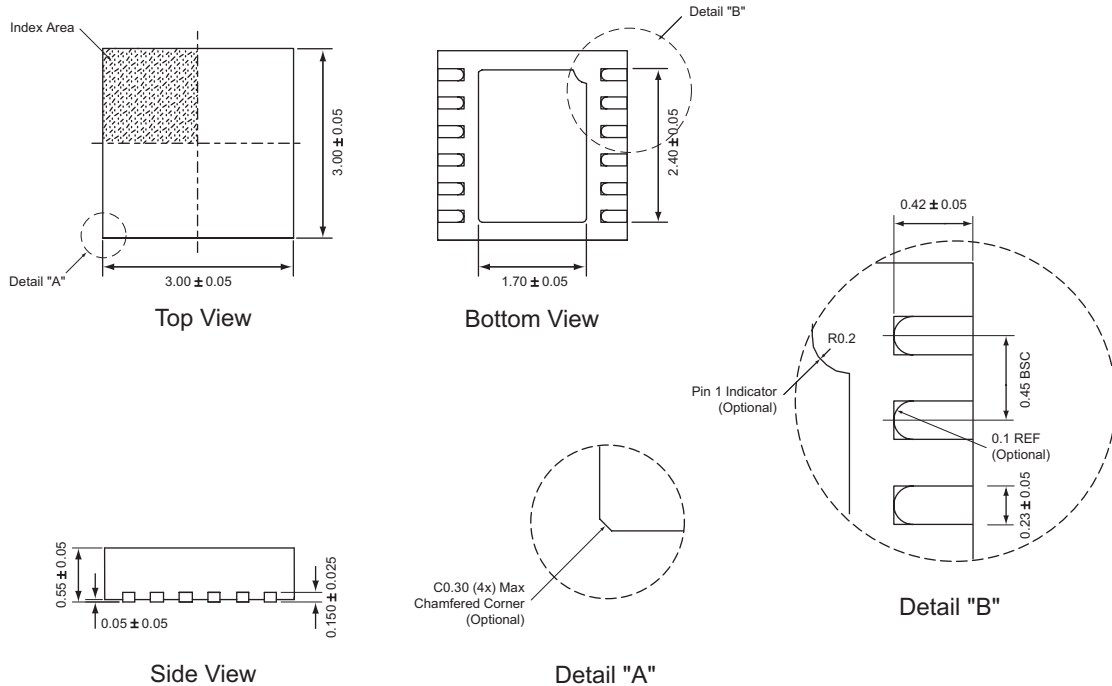

All dimensions in millimeters.

© Advanced Analogic Technologies, Inc.

AnalogicTech cannot assume responsibility for use of any circuitry other than circuitry entirely embodied in an AnalogicTech product. No circuit patent licenses, copyrights, mask work rights, or other intellectual property rights are implied. AnalogicTech reserves the right to make changes to their products or specifications or to discontinue any product or service without notice. Customers are advised to obtain the latest version of relevant information to verify, before placing orders, that information being relied on is current and complete. All products are sold subject to the terms and conditions of sale supplied at the time of order acknowledgement, including those pertaining to warranty, patent infringement, and limitation of liability. AnalogicTech warrants performance of its semiconductor products to the specifications applicable at the time of sale in accordance with AnalogicTech's standard warranty. Testing and other quality control techniques are utilized to the extent AnalogicTech deems necessary to support this warranty. Specific testing of all parameters of each device is not necessarily performed.

AnalogicTech and the AnalogicTech logo are trademarks of Advanced Analogic Technologies Incorporated. All other brand and product names appearing in this document are registered trademarks or trademarks of their respective holders.

**Advanced Analogic Technologies, Inc.**  
 830 E. Arques Avenue, Sunnyvale, CA 94085  
 Phone (408) 737-4600  
 Fax (408) 737-4611