

DATA SHEET

AC01/03/04/05/07/10/15/20
Cemented wirewound resistors

Product specification
Supersedes data of 17th November 1998
File under BCcomponents, BC08

2000 Oct 20

Cemented wirewound resistors AC01/O3/O4/O5/O7/10/15/20

FEATURES

- High power dissipation in small volume
- High pulse load handling capabilities.

APPLICATIONS

- Ballast switching
- Shunt in small electric motors
- Power supplies.

DESCRIPTION

The resistor element is a resistive wire which is wound in a single layer on a ceramic rod. Metal caps are pressed over the ends of the rod.

The ends of the resistance wire and the leads are connected to the caps by welding. Tinned copper-clad iron leads with poor heat conductivity are employed permitting the use of relatively short leads to obtain stable mounting without overheating the solder joint.

The resistor is coated with a green silicon cement which is not resistant to aggressive fluxes. The coating is non-flammable, will not drip even at high overloads and is resistant to most commonly used cleaning solvents, in accordance with "MIL-STD-202E, method 215" and "IEC 60068-2-45".

QUICK REFERENCE DATA

DESCRIPTION	VALUE							
	AC01	AC03	AC04	AC05	AC07	AC10	AC15	AC20
Resistance range	0.1 Ω to 2.4 kΩ	0.1 Ω to 5.1 kΩ	0.1 Ω to 6.8 kΩ	0.1 Ω to 10 kΩ	0.1 Ω to 15 kΩ	0.68 Ω to 27 kΩ	0.82 Ω to 39 kΩ	1.2 Ω to 56 kΩ
Resistance tolerance	±5%; E24 series							
Maximum permissible body temperature	350 °C							
Rated dissipation at T _{amb} = 40 °C	1 W	3 W	4 W	5 W	7 W	10 W	15 W	20 W
Rated dissipation at T _{amb} = 70 °C	0.9 W	2.5 W	3.5 W	4.7 W	5.8 W	8.4 W	12.5 W	16 W
Climatic category (IEC 60068)	40/200/56							
Basic specification	IEC 60115-1							
Stability after:								
load, 1000 hours	ΔR/R max.: ±5% + 0.1 Ω							
climatic tests	ΔR/R max.: ±1% + 0.05 Ω							
short time overload	ΔR/R max.: ±2% + 0.1 Ω							

Cemented wirewound resistors

AC01/03/04/05/07/10/15/20

ORDERING INFORMATION

Table 1 Ordering code indicating resistor type and packaging

TYPE	ORDERING CODE 23..			
	LOOSE IN BOX	BANDOLIER IN AMMOPACK		
	STRAIGHT LEADS	RADIAL	STRAIGHT LEADS	
	100 units	2500 units	500 units	1000 units
AC01	–	06 328 90...(2)	–	06 328 33...
AC03(1)	–	–	22 329 03...	–
AC04(1)	–	–	22 329 04...	–
AC05(1)	–	–	22 329 05...	–
AC07(1)	–	–	22 329 07...	–
AC10	–	–	22 329 10...	–
AC15	22 329 15...	–	–	–
AC20	22 329 20...	–	–	–

Notes

1. Products with bent leads and loose in box, are available on request.
2. Last 3 digits available on request.

Ordering code (12NC)

- The resistors have a 12-digit ordering code starting with 23
- The subsequent 7 digits indicate the resistor type and packaging; see Table 1.
- The remaining 3 digits indicate the resistance value:
 - The first 2 digits indicate the resistance value.
 - The last digit indicates the resistance decade in accordance with Table 2.

Table 2 Last digit of 12NC

RESISTANCE DECADE	LAST DIGIT
0.1 to 0.91 Ω	7
1 to 9.1 Ω	8
10 to 91 Ω	9
100 to 910 Ω	1
1 to 9.1 k Ω	2
10 to 56 k Ω	3

ORDERING EXAMPLE

The ordering code of an AC01 resistor, value 47 Ω , supplied in ammopack of 1000 units is: 2306 328 33479.

Product specifications deviating from the standard values are available on request.

Cemented wirewound resistors

AC01/03/04/05/07/10/15/20

FUNCTIONAL DESCRIPTION

Product characterization

Standard values of nominal resistance are taken from the E24 series for resistors with a tolerance of $\pm 5\%$.

The values of the E24 series are in accordance with "IEC publication 60063".

Limiting values

TYPE	LIMITING VOLTAGE ⁽¹⁾ (V)	LIMITING POWER (W)	
		T _{amb} = 40 °C	T _{amb} = 70 °C
AC01	$V = \sqrt{P_n \times R}$	1	0.9
AC03		3	2.5
AC04		4	3.5
AC05		5	4.7
AC07		7	5.8
AC10		10	8.4
AC15		15	12.5
AC20		20	16.0

Note

1. The maximum voltage that may be continuously applied to the resistor element, see "IEC publication 60266".

The maximum permissible hot-spot temperature is 350 °C.

DERATING

The power that the resistor can dissipate depends on the operating temperature; see Fig.1.

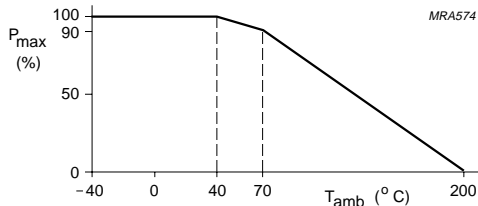

Fig.1 Maximum dissipation (P_{max}) as a function of the ambient temperature (T_{amb}).

Cemented wirewound resistors

AC01/03/04/05/07/10/15/20

PULSE LOADING CAPABILITIES

How to generate the maximum allowed pulse-load from the graphs composed for wirewound resistors of the AC-types.

Single pulse condition; see Fig.3

1. If the applied pulse energy in Joules or Wattseconds is known and also the R-value to be used in the application; take the R-value on the X-axis and go vertically to the curved line. From this point go horizontally to the Y-axis, this point gives the maximum allowed pulse energy in Joules/ohm or Wattsec./ohm. By multiplying this figure with R-value in use gives the maximum allowed pulse-energy in Joules or Wattsec. If this figure is higher than the applied pulse-energy the application is allowed. Otherwise take one of the other graphs belonging to AC-types with higher P_n .
2. If, contrary to the information above, the applied peak-voltage and impulse times t_i are known. Calculate the pulse-energy (E_p) in Joules or Wattsec. by the use of the following formula:

$$E_p = \frac{V_p^2}{R} \times t_i \quad (V_p = \text{peak voltage}; t_i = \text{impulse-time})$$

By dividing this result with the R_n -value of the R in use, gives the value Wattsec./ohm on the Y-axis. Draw a line horizontally to the curved line and at the intersection the vertical line to the X-axis gives the maximum allowed R_n -value to be used in the application. If this R_n -value is higher than the R-value to be used in the application, the application is allowed. If not, take one of the other graphs belonging to AC-types with higher P_n or change the R_n -value to be used.

Repetitive pulse condition; see Fig.2

With these graphs we can determine the allowed pulse-energy in Watts depending on the impulse-time t_i and the repetition time t_p of the pulses. The parameter is the Resistance Value. If the pulse shape is known (impulse-time t_i and repetition time t_p), draw a line vertically from the X-axis at the mentioned t_i to the line of the involved R-value. From the intersection the horizontal line to the Y-axis indicates the maximum allowed pulse-load at a certain t_p/t_i . If the vertical line from the X-axis crosses the applied t_p/t_i before reaching the R-line, this t_p/t_i line gives the maximum allowed pulse-energy at the Y-axis. If the applied pulse-energy is known (in Watts) and the impulse-time t_i also, draw a line horizontally from the Y-axis to the crossing with the pulse-line (t_i) and find the possible R-value needed in this application. The horizontal t_p/t_i lines give the maximum allowed pulse-load till they reach the R-line, that point indicates the maximum allowed impulse-time t_i at the horizontal axis.

Cemented wirewound resistors

AC01/03/04/05/07/10/15/20

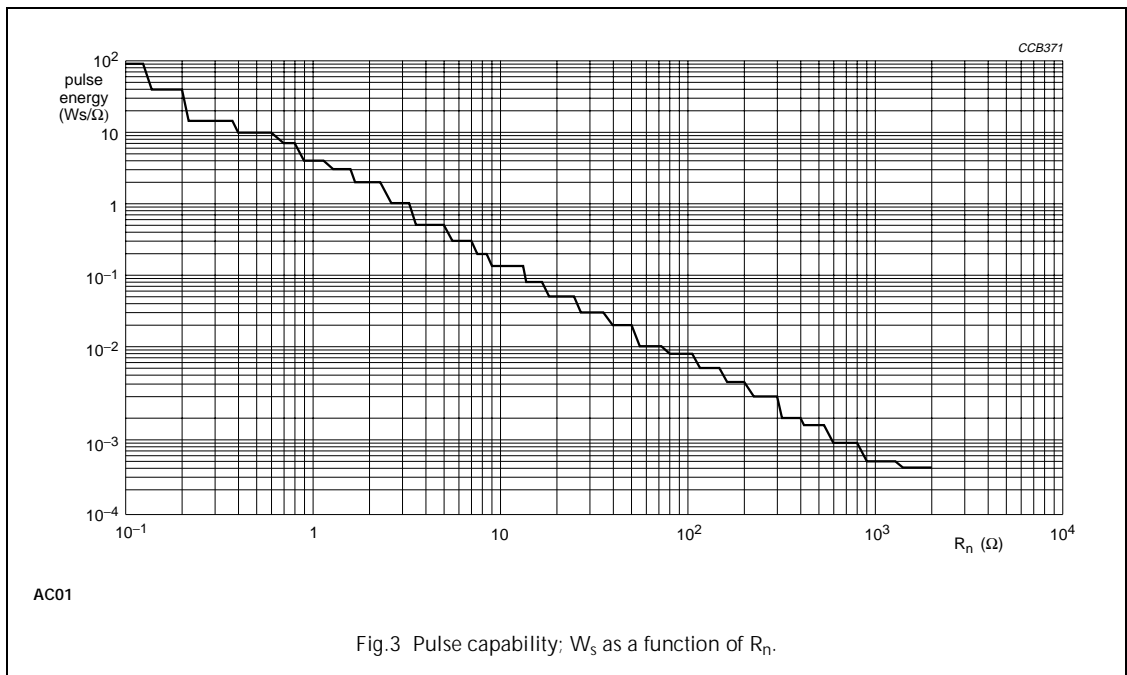
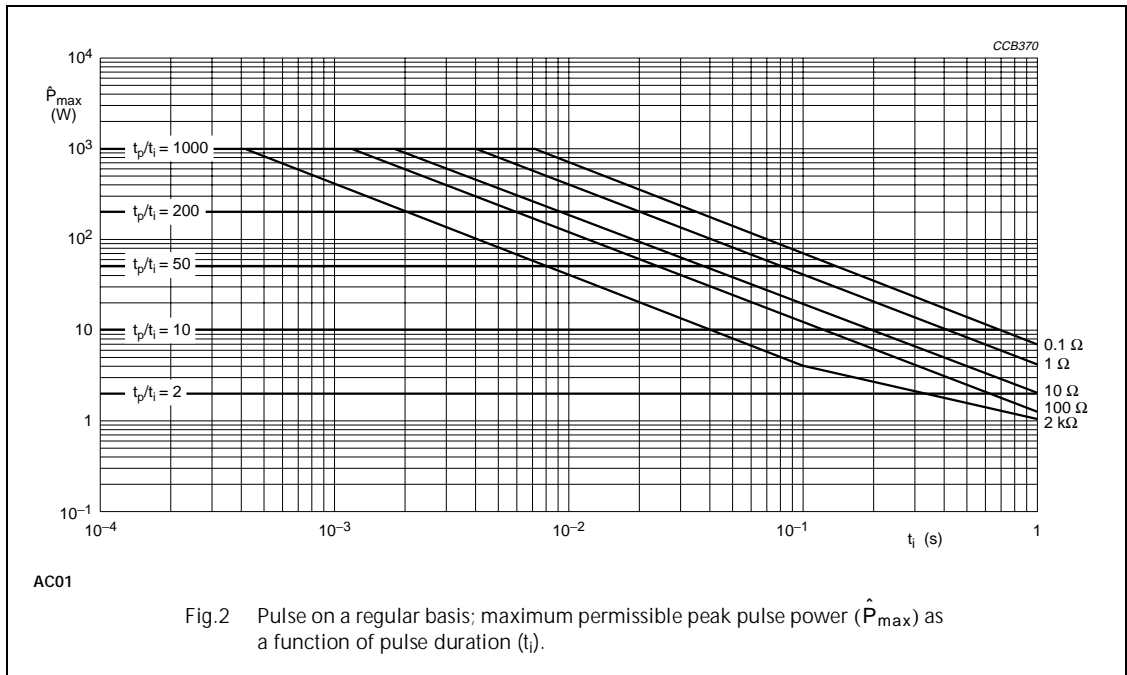

Cemented wirewound resistors

AC01/03/04/05/07/10/15/20

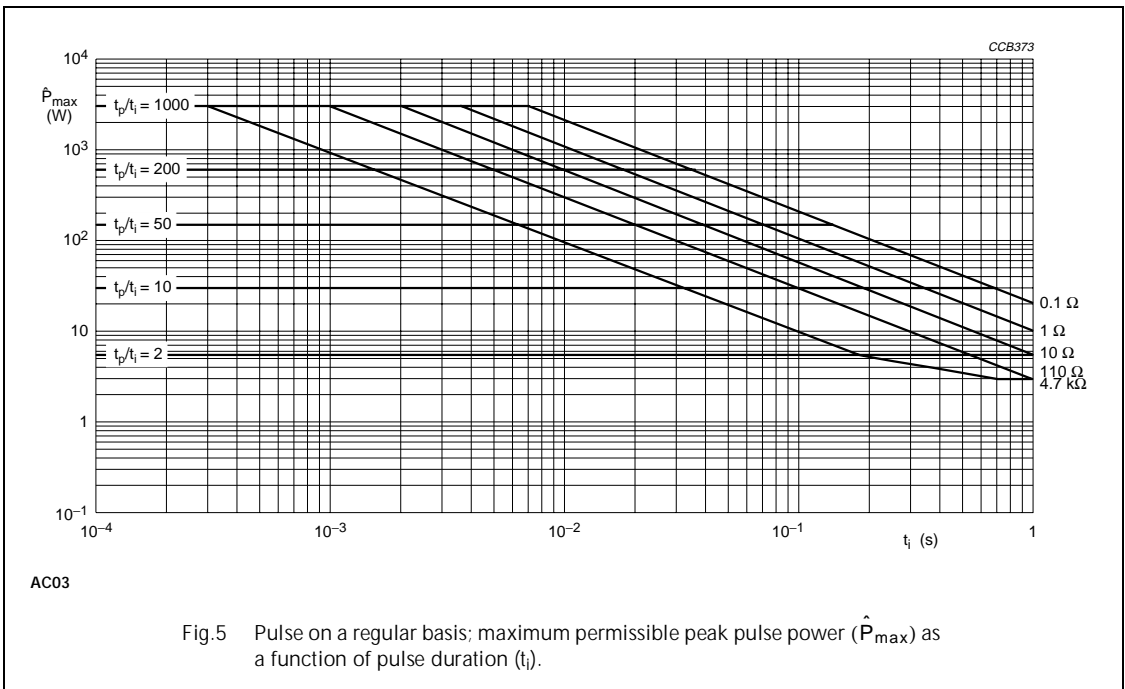
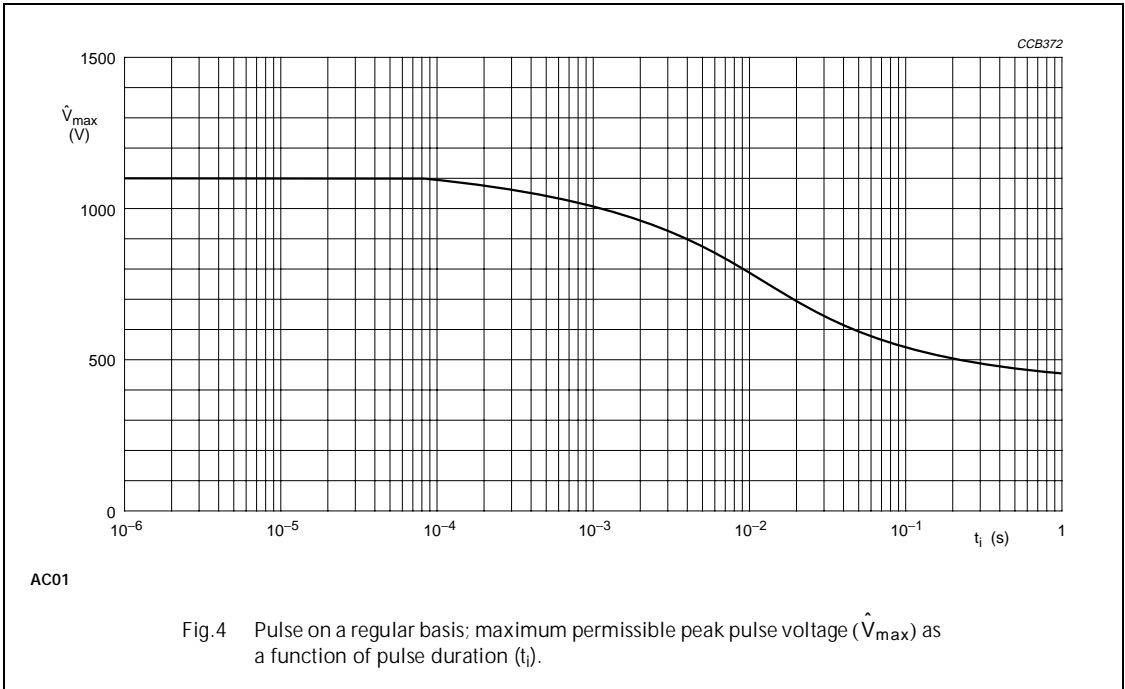

Cemented wirewound resistors

AC01/03/04/05/07/10/15/20

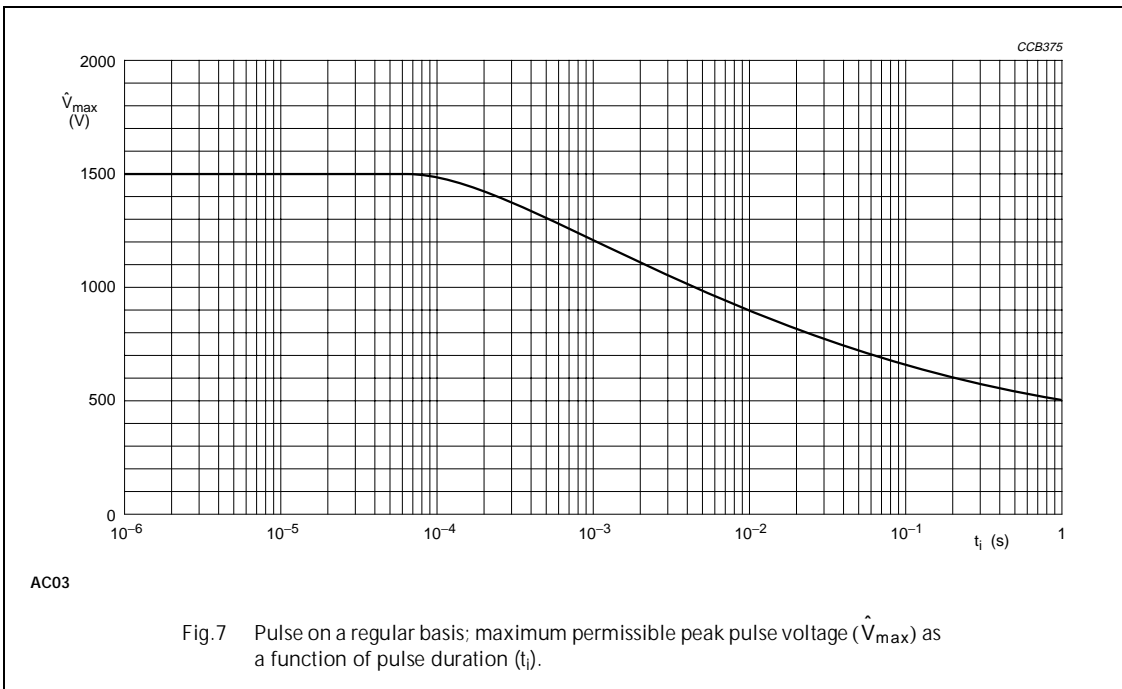
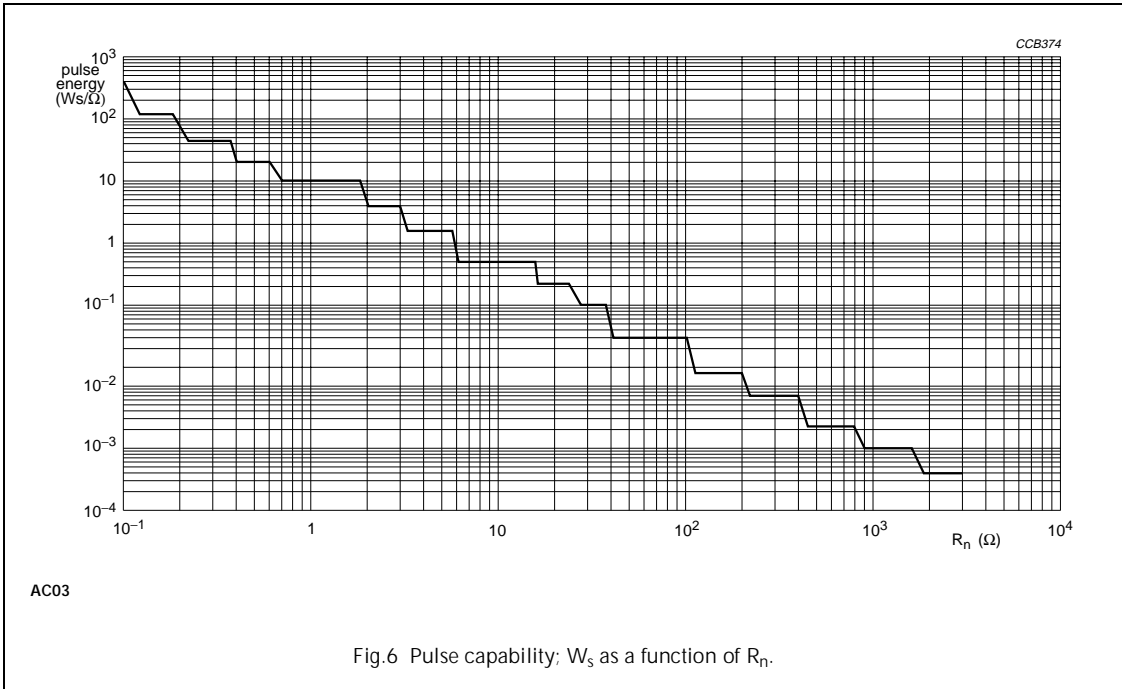

Cemented wirewound resistors

AC01/03/04/05/07/10/15/20

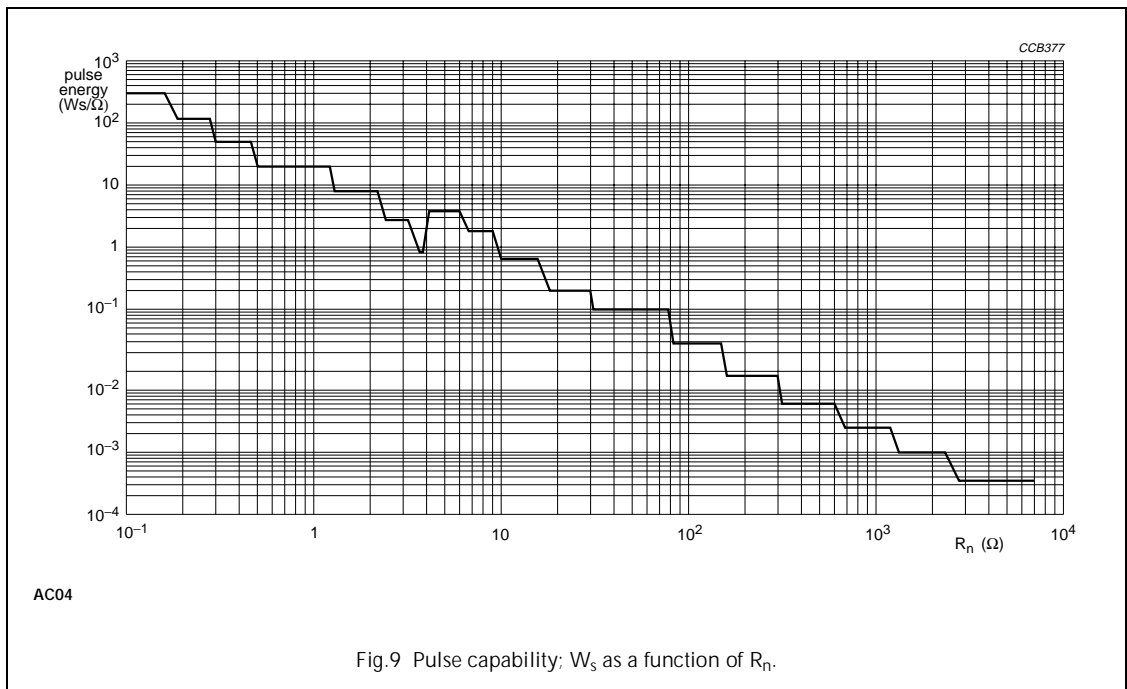
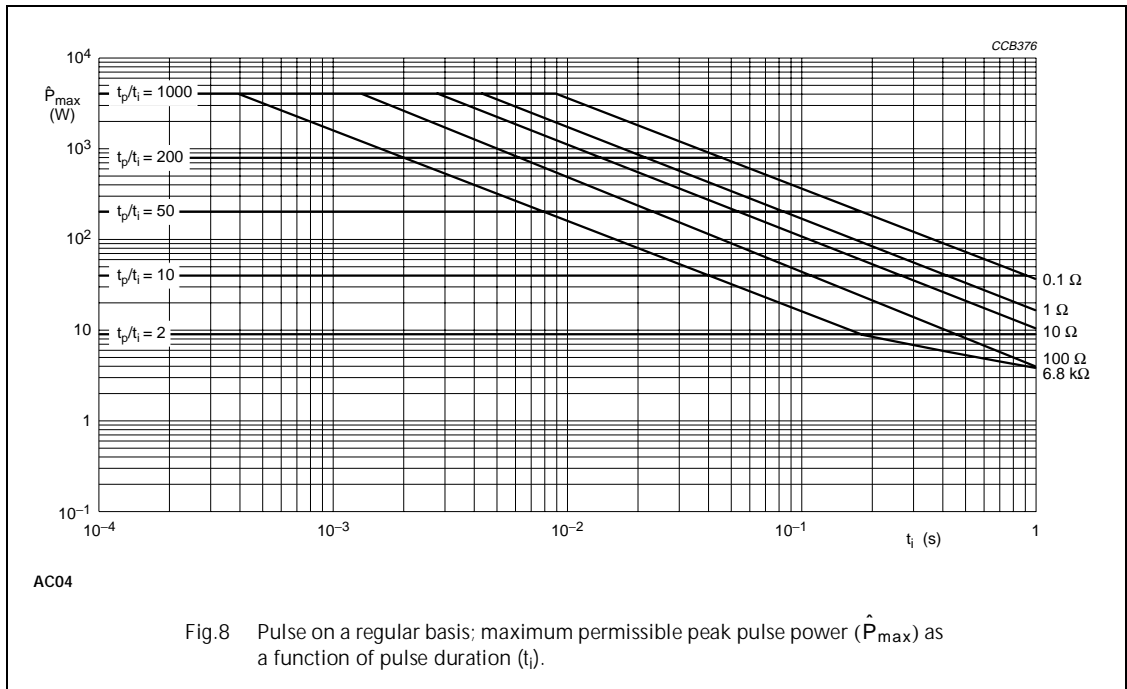

Cemented wirewound resistors

AC01/03/04/05/07/10/15/20

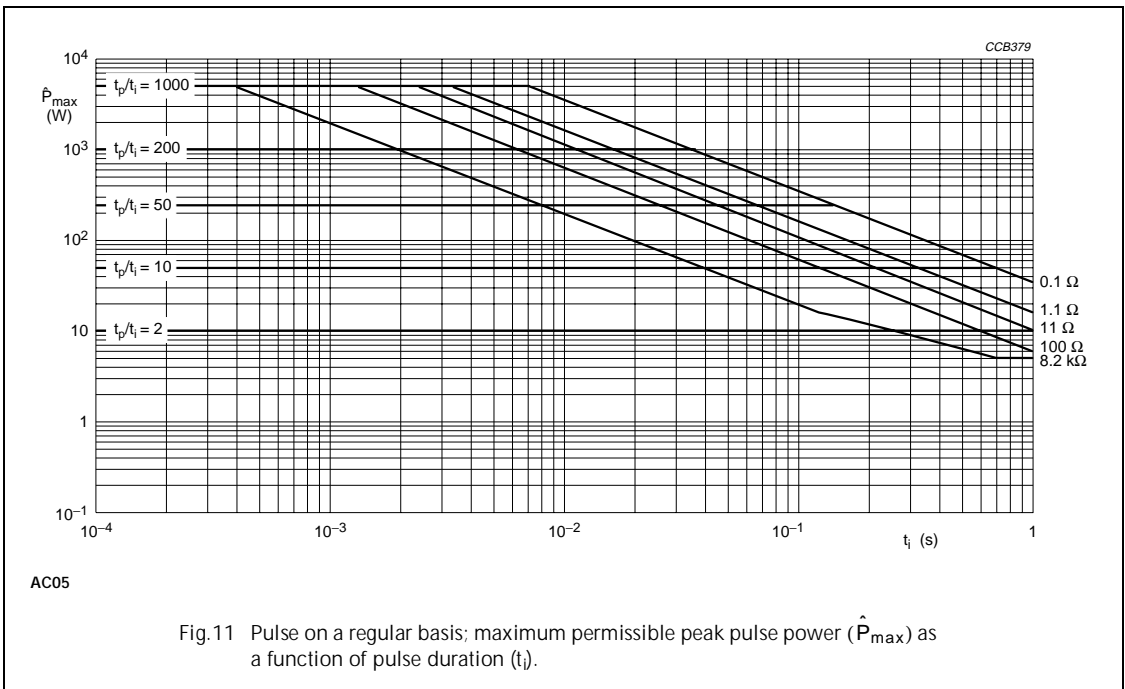
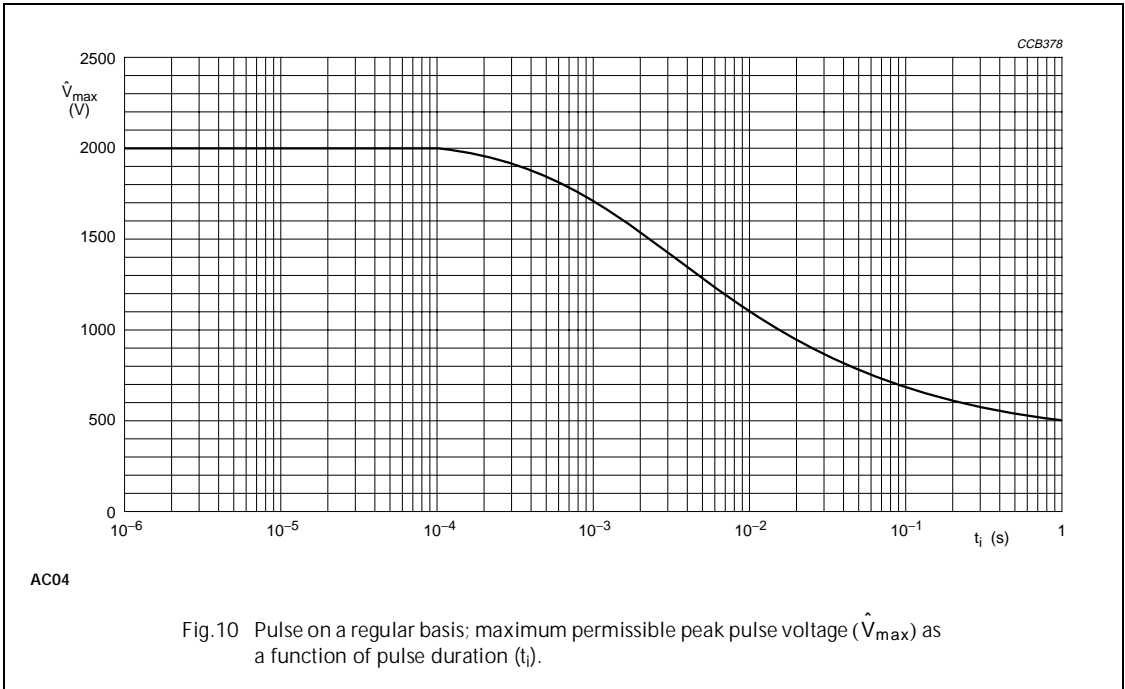

Cemented wirewound resistors

AC01/03/04/05/07/10/15/20

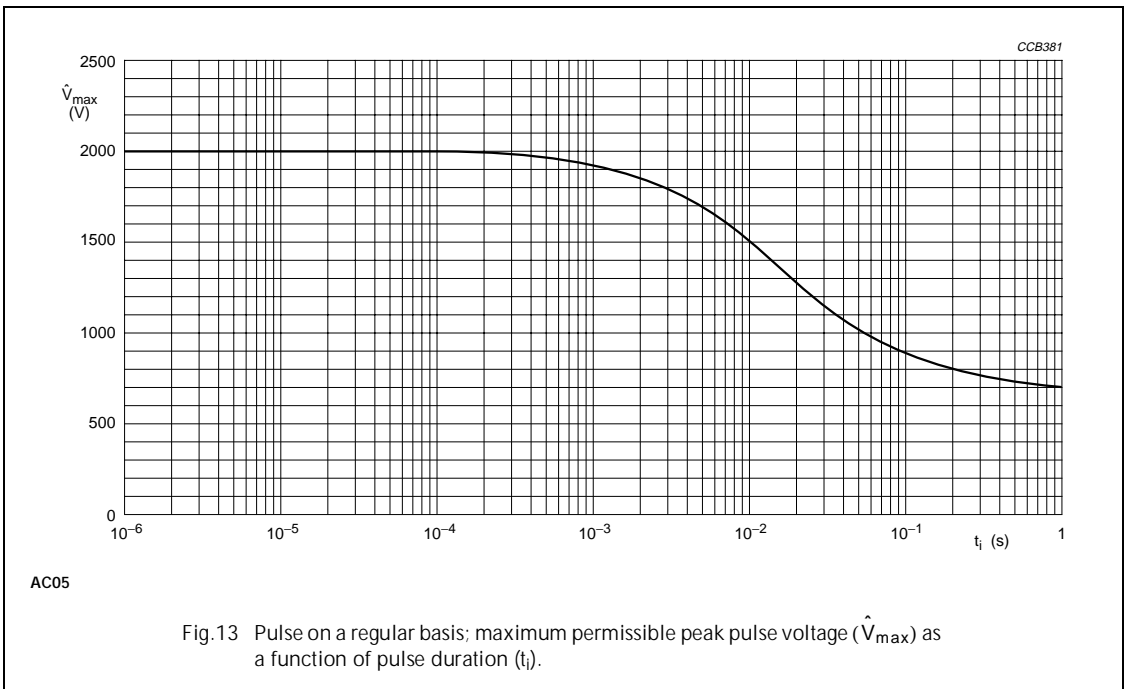
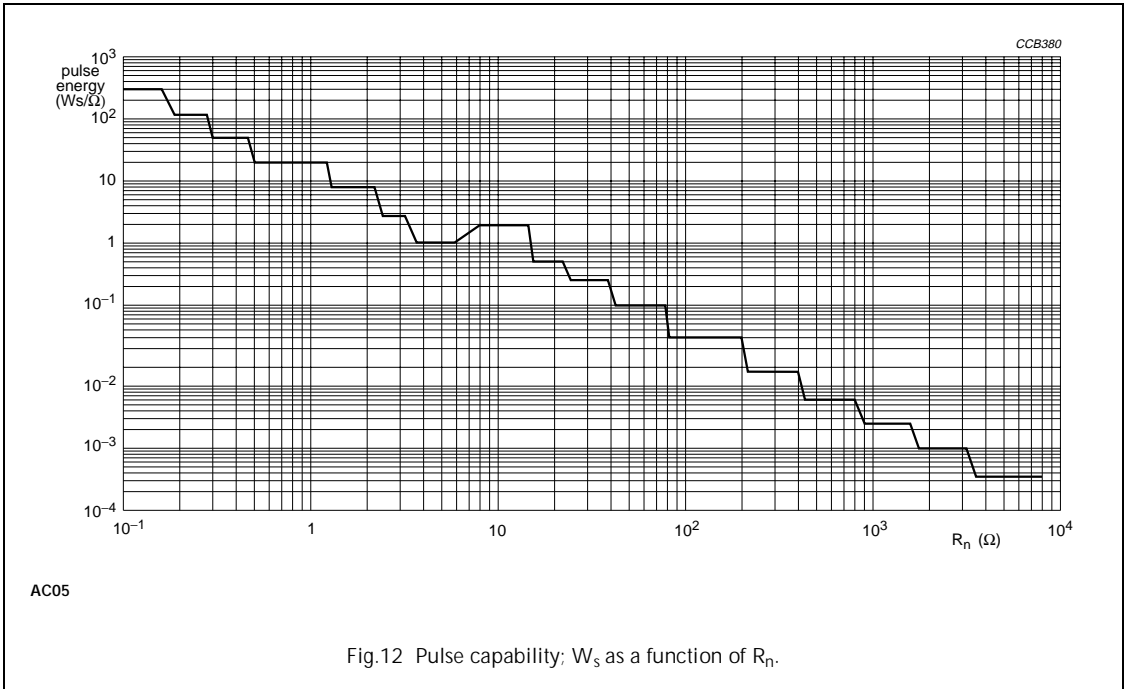

Cemented wirewound resistors

AC01/03/04/05/07/10/15/20

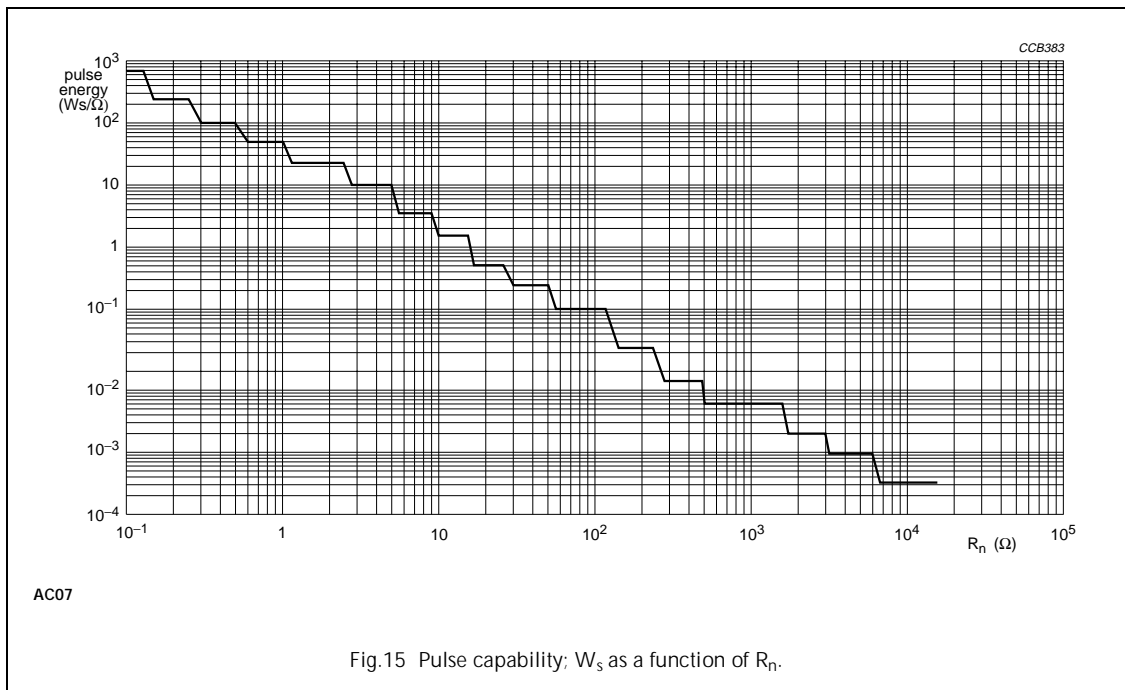
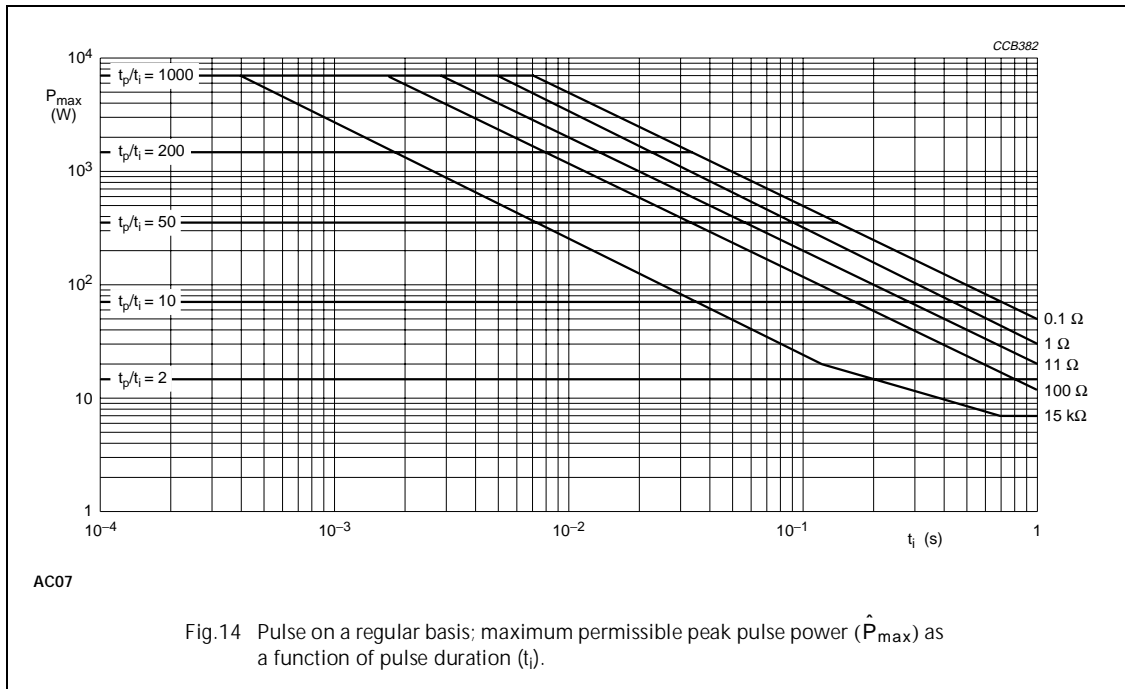

Cemented wirewound resistors

AC01/03/04/05/07/10/15/20

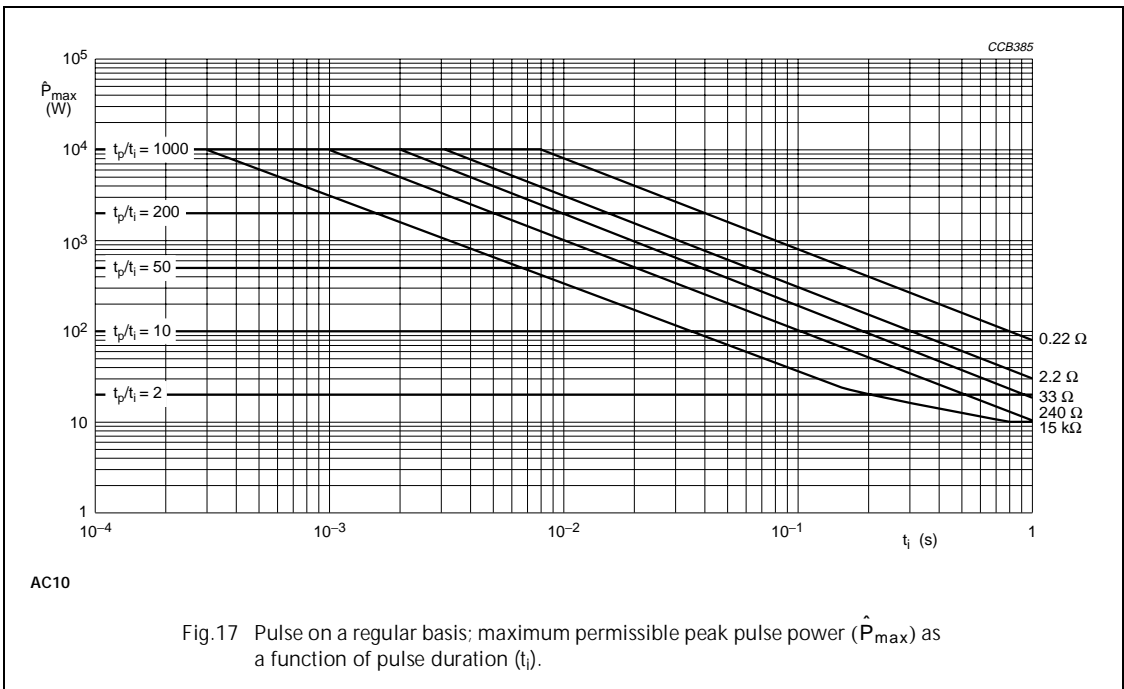
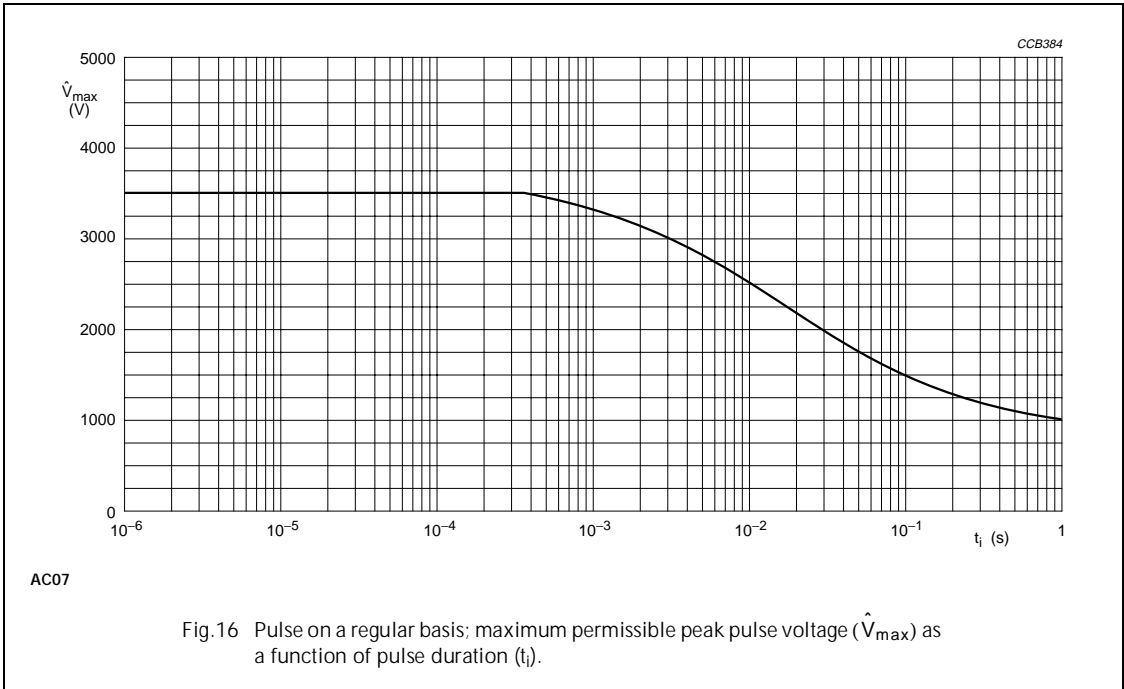

Cemented wirewound resistors

AC01/03/04/05/07/10/15/20

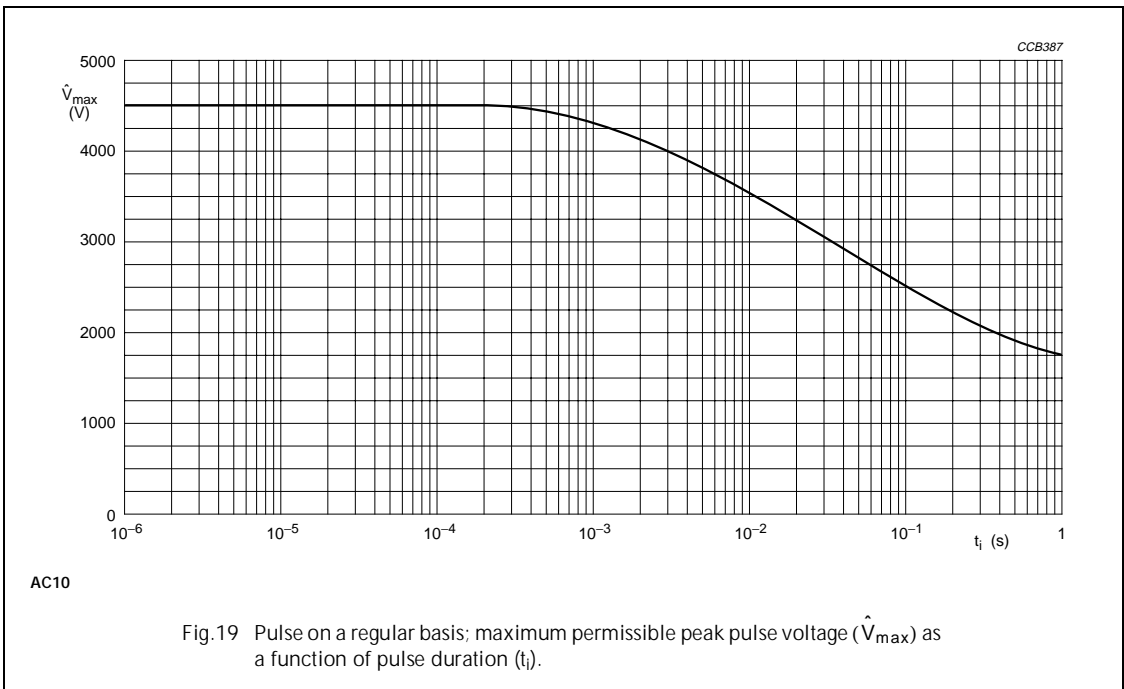
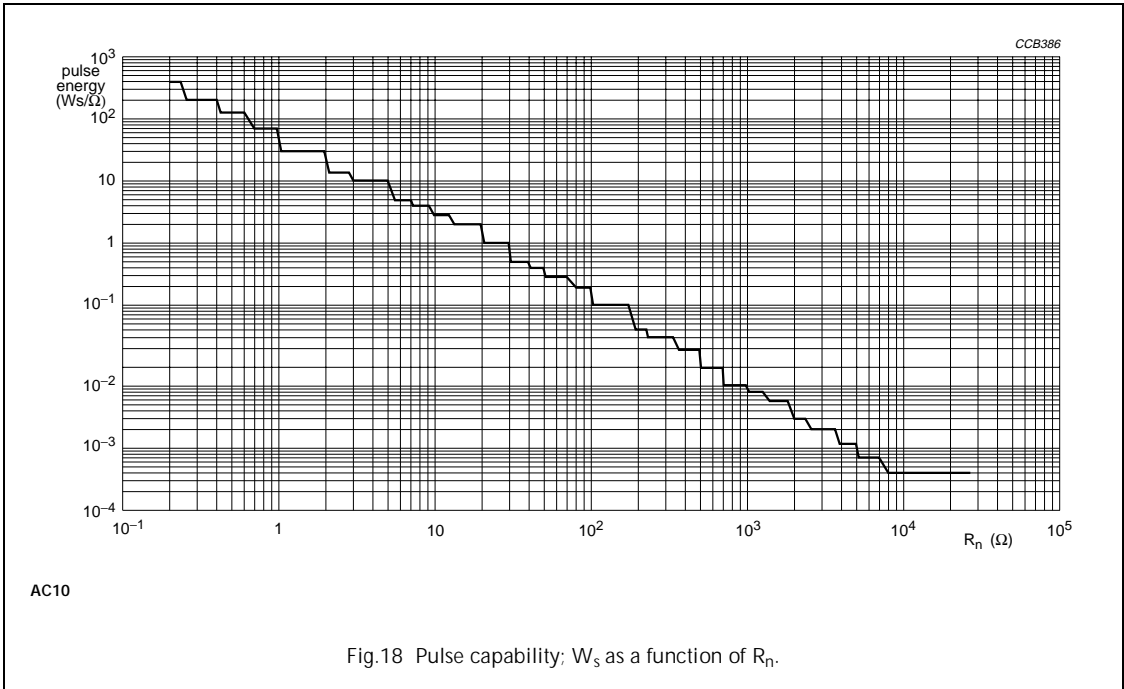

Cemented wirewound resistors

AC01/03/04/05/07/10/15/20

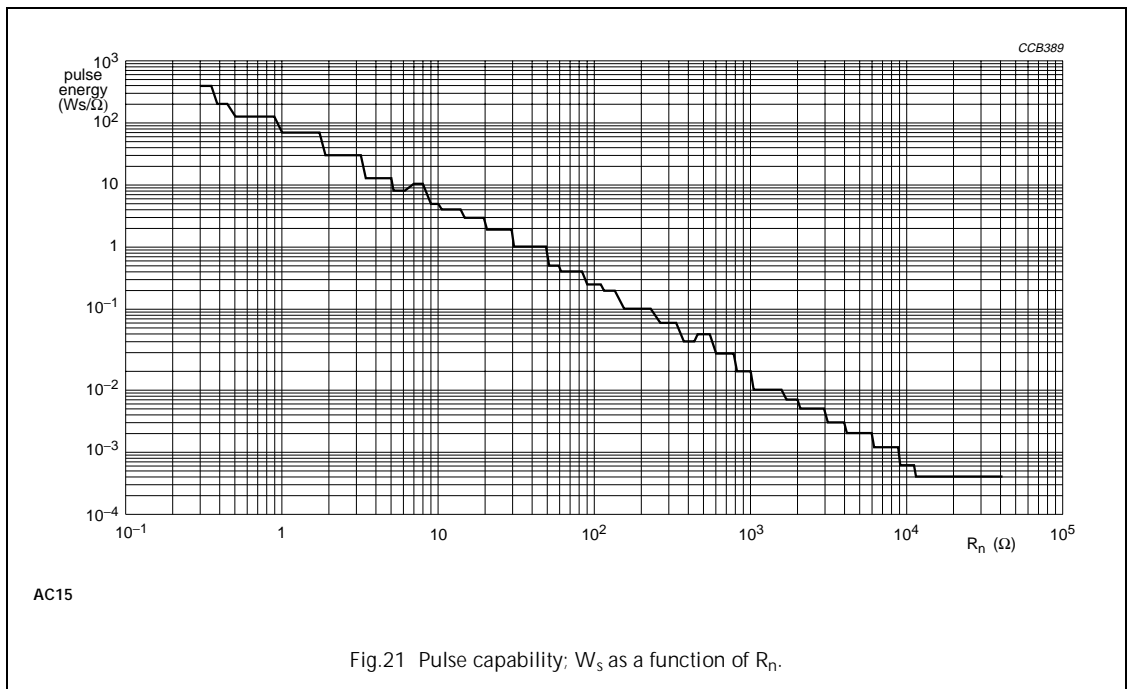
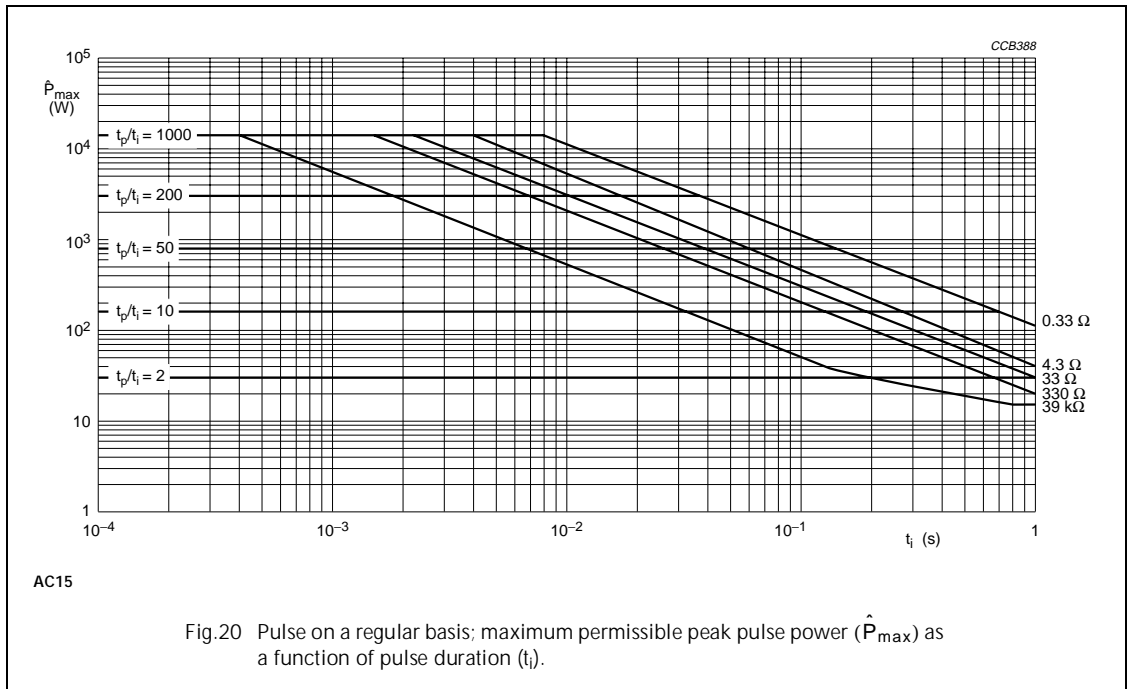

Cemented wirewound resistors

AC01/03/04/05/07/10/15/20

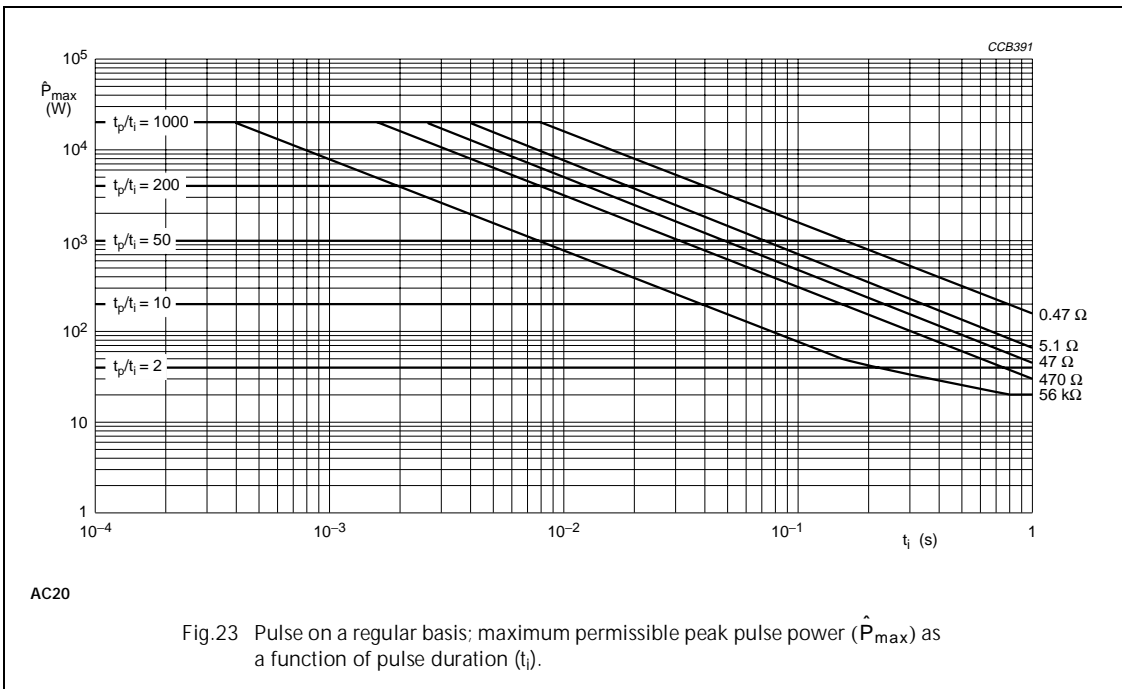
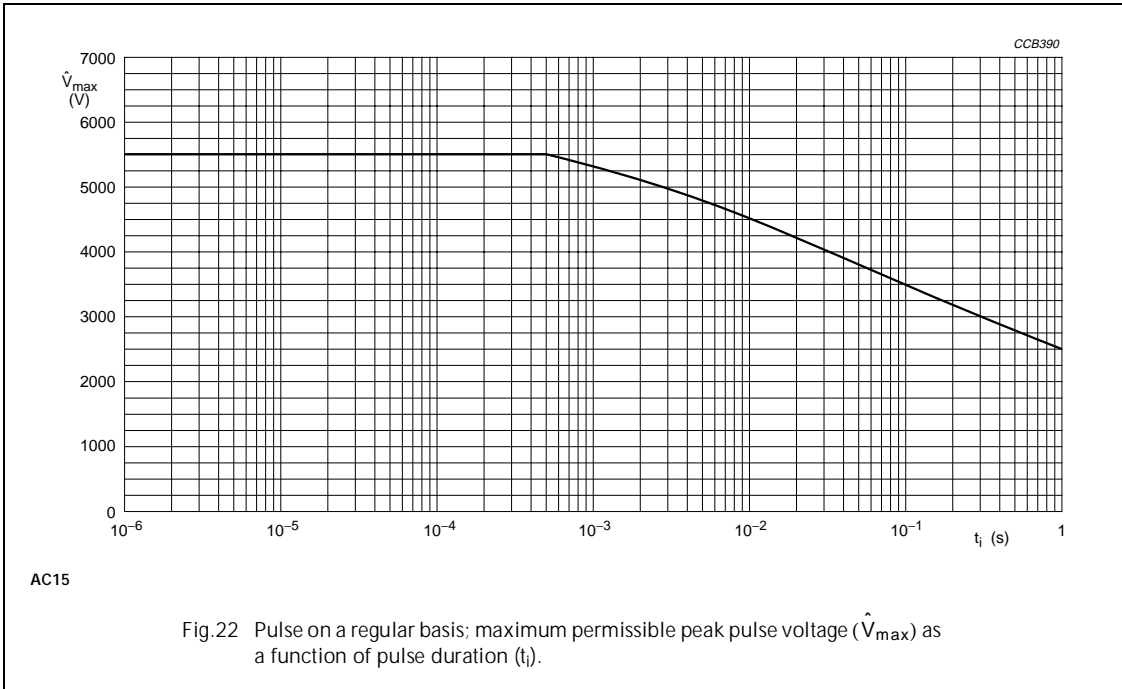

Cemented wirewound resistors

AC01/03/04/05/07/10/15/20

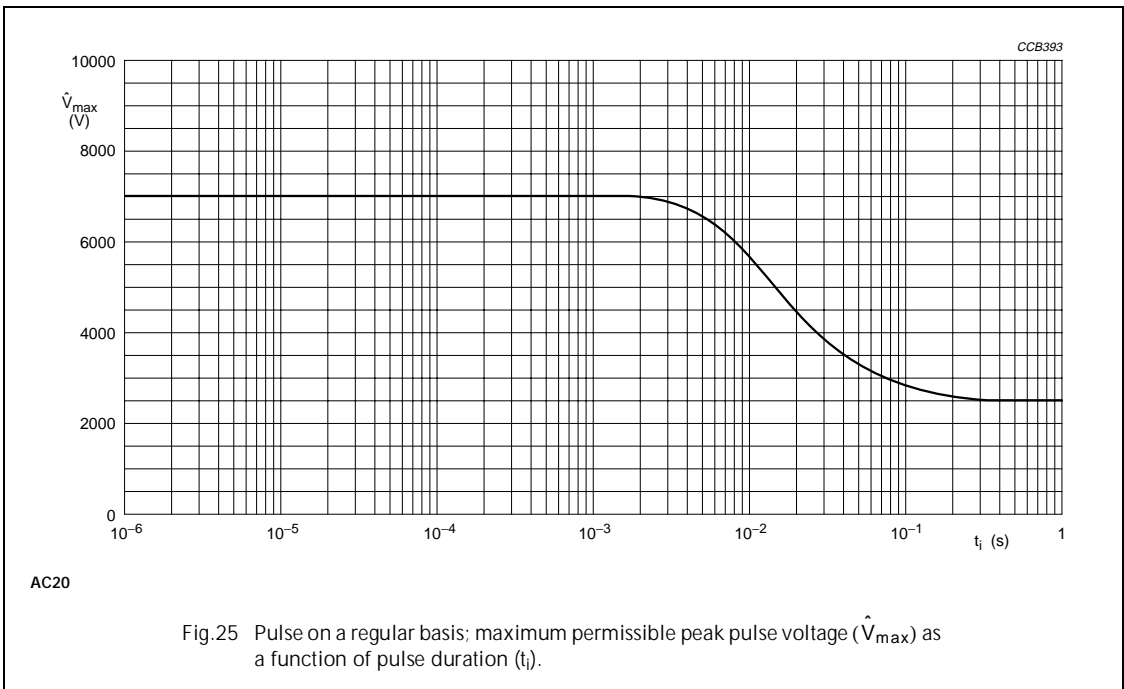
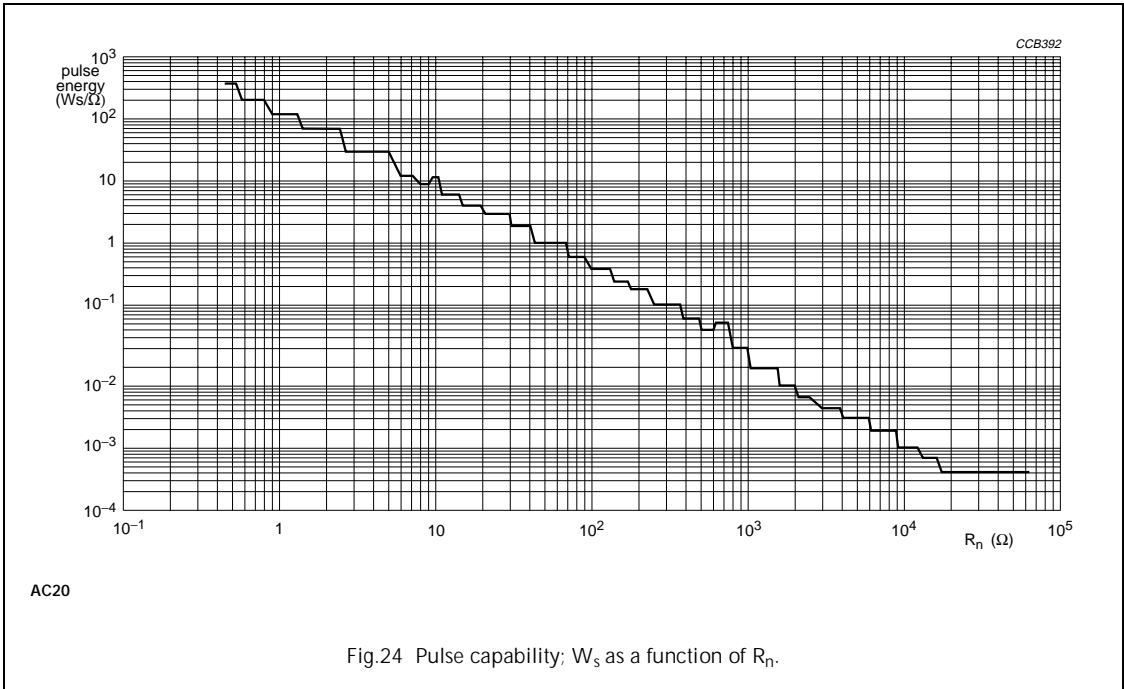

Cemented wirewound resistors

AC01/03/04/05/07/10/15/20

Application information

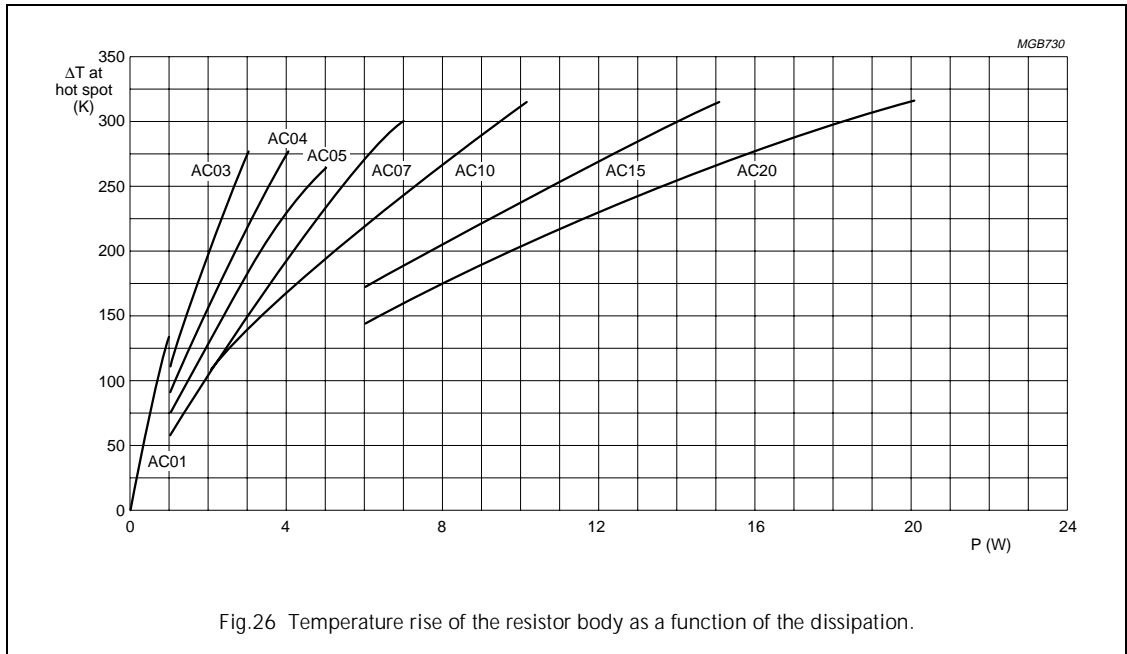
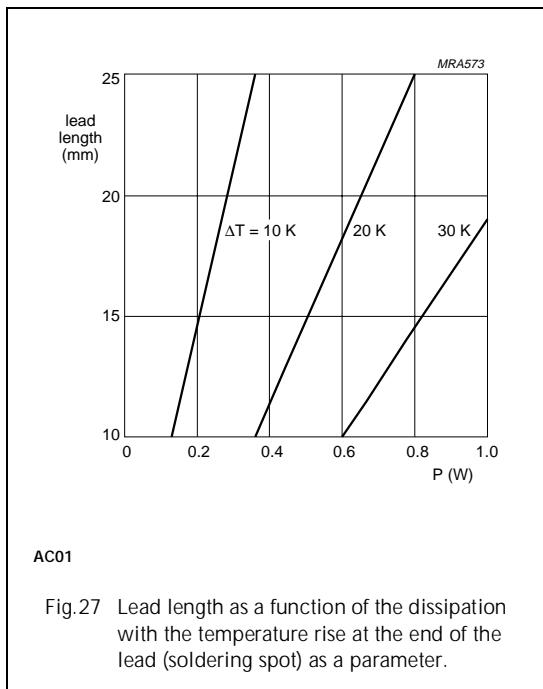
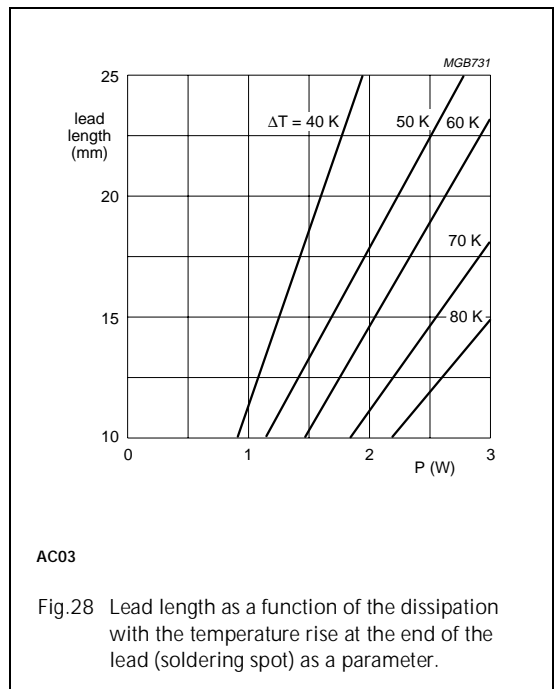

Fig.26 Temperature rise of the resistor body as a function of the dissipation.



AC01

Fig.27 Lead length as a function of the dissipation with the temperature rise at the end of the lead (soldering spot) as a parameter.



AC03

Fig.28 Lead length as a function of the dissipation with the temperature rise at the end of the lead (soldering spot) as a parameter.

Cemented wirewound resistors

AC01/03/04/05/07/10/15/20

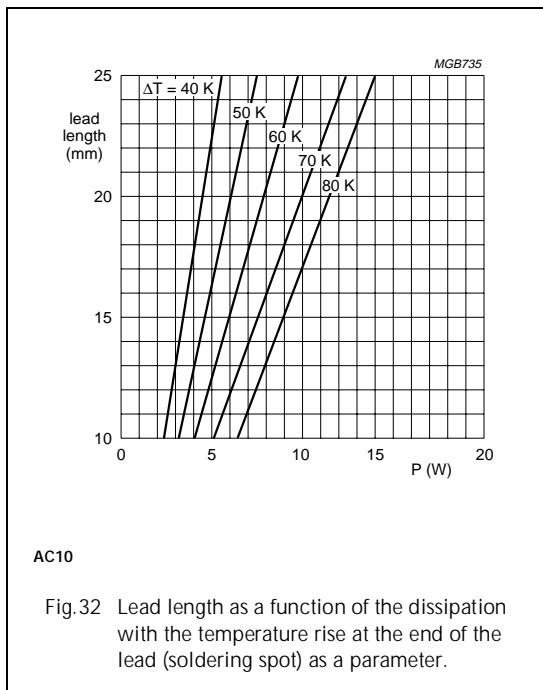
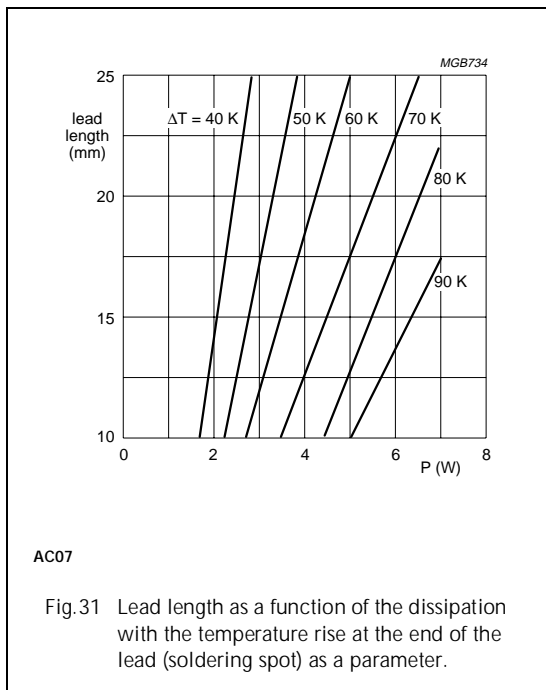
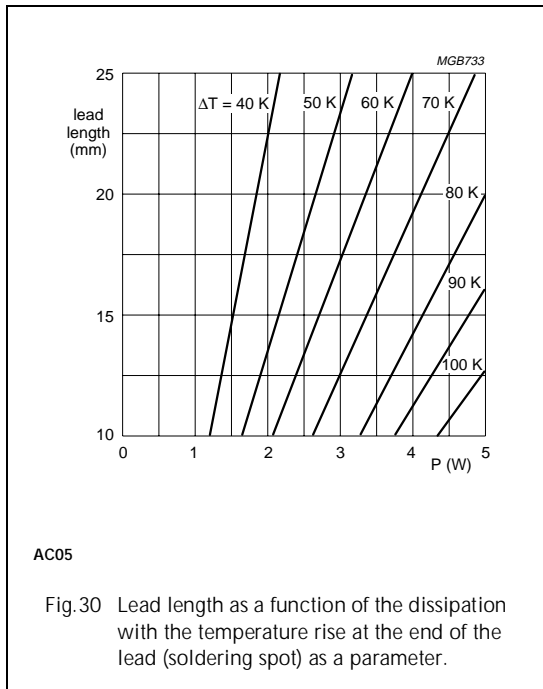
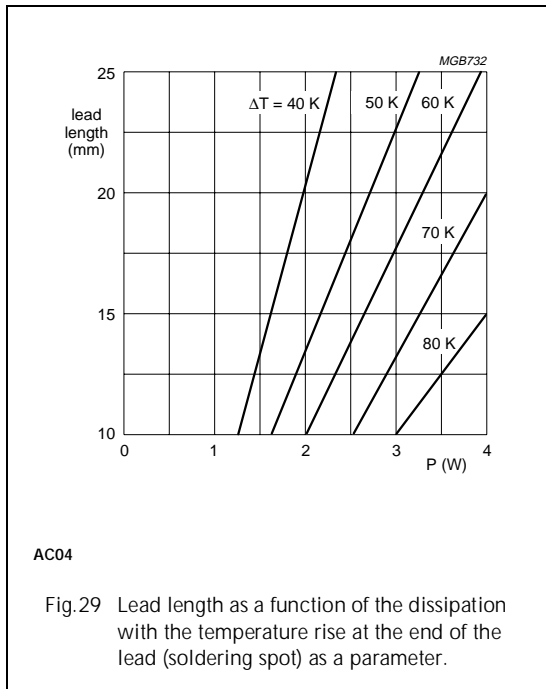

Cemented wirewound resistors

AC01/03/04/05/07/10/15/20

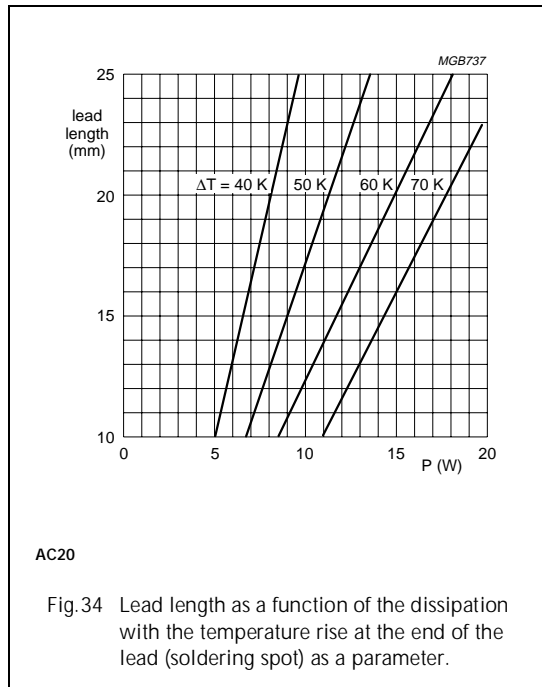
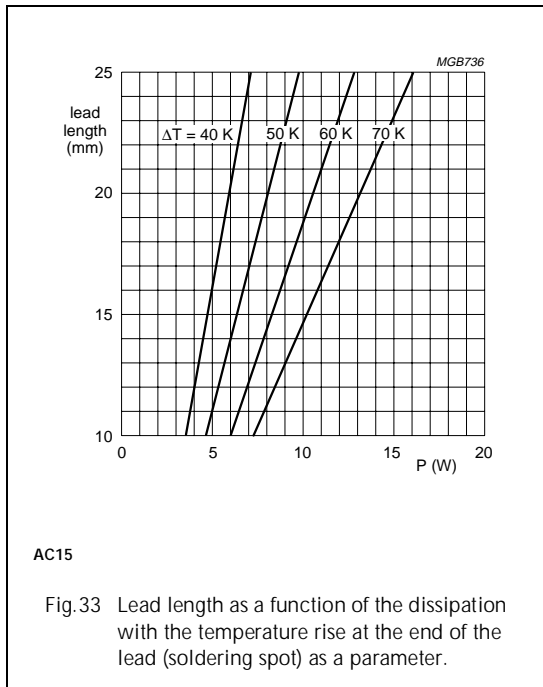

MOUNTING

The resistor is suitable for processing on cutting and bending machines. **Ensure that the temperature rise of the resistor body does not affect nearby components or materials by conducted or convected heat.** Figure 26 shows the hot-spot temperature rise of the resistor body as a function of dissipated power. Figures 27 to 34 show the lead length as a function of dissipated power and temperature rise.

Cemented wirewound resistors

AC01/03/04/05/07/10/15/20

MECHANICAL DATA

Mass per 100 units

TYPE	MASS (g)
AC01	55
AC03	110
AC04	140
AC05	220
AC07	300
AC10	530
AC15	840
AC20	1090

Marking

The resistor is marked with the nominal resistance value, the tolerance on the resistance and the rated dissipation at $T_{amb} = 40\text{ }^{\circ}\text{C}$.

For values up to $910\ \Omega$, the R is used as the decimal point.

For values of $1\ \text{k}\Omega$ and upwards, the letter K is used as the decimal point for the $\text{k}\Omega$ indication.

Outlines

Table 3 Resistor type and relevant physical dimensions; see Figs 35 and 36

TYPE	$\varnothing D$ MAX. (mm)	L MAX. (mm)	$\varnothing d$ (mm)	b (mm)	h (mm)	P (mm)	S MAX. (mm)	$\varnothing B$ MAX. (mm)
AC01	4.3	10	0.8 ± 0.03	–	–	–	–	–
AC03	5.5	13		1.3	8	10e	2	1.2
AC04	5.7	17				13e		
AC05	7.5	17		–	–	–	–	–
AC07	7.5	25		–	–	–	–	–
AC10	8	44		–	–	–	–	–
AC15	10	51		–	–	–	–	–
AC20	10	67		–	–	–	–	–

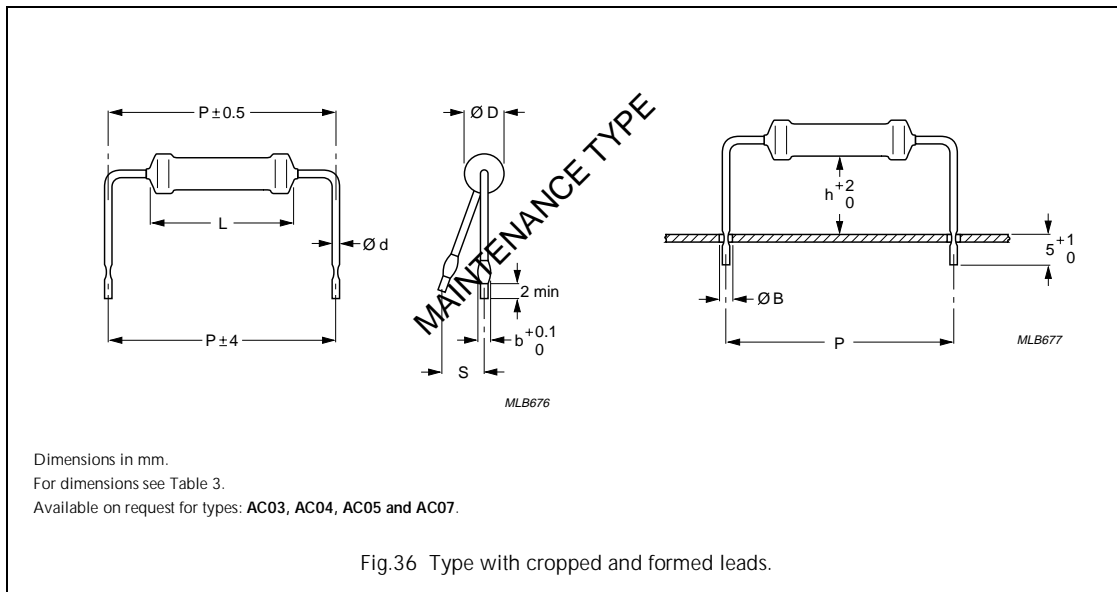
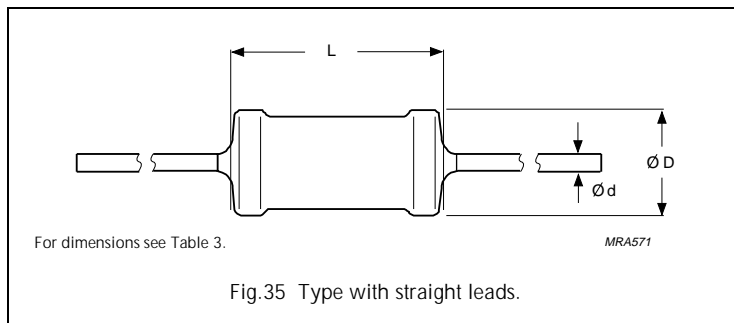

Cemented wirewound resistors

AC01/03/04/05/07/10/15/20

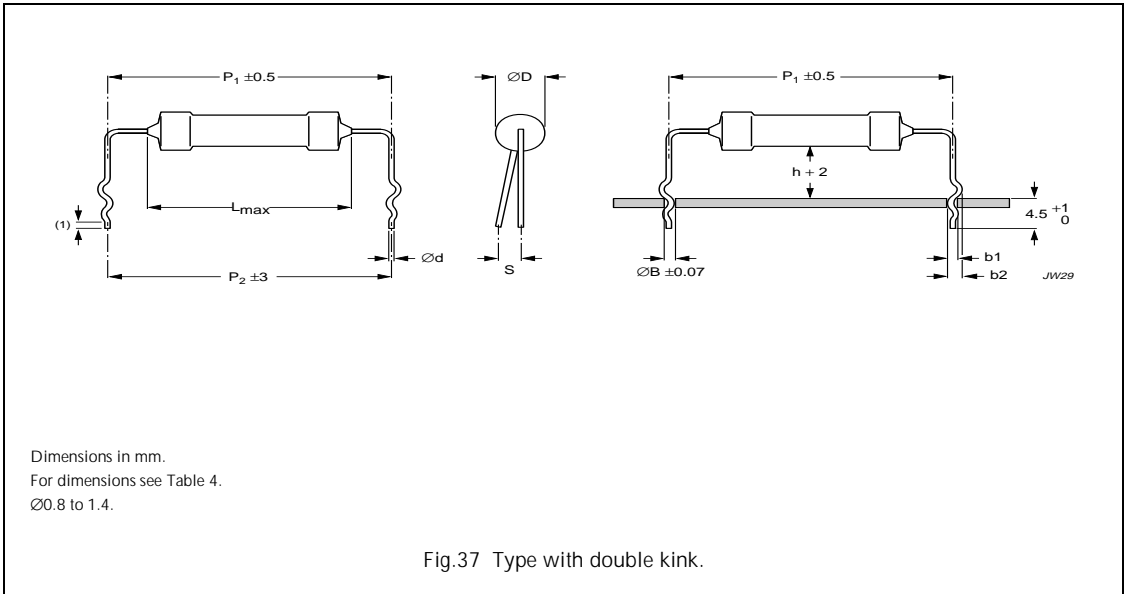

Table 4 Resistor type and relevant physical dimensions; see Fig.37

TYPE	LEAD STYLE	ØD (mm)	L MAX. (mm)	b ₁ (mm)	b ₂ (mm)	h (mm)	P ₁ (mm)	P ₂ (mm)	S MAX. (mm)	ØB (mm)
AC03 AC04 AC05	double kink large pitch	0.8 ±0.03	10	1.30 +0.25/-0.20	1.65 +0.25/-0.20	8	25.4	25.4	2	1.0
AC03 AC04 AC05	double kink small pitch	0.8 ±0.03	10	1.30 +0.25/-0.20	2.15 +0.25/-0.20	8	22.0	20.0	2	1.0

Cemented wirewound resistors

AC01/03/04/05/07/10/15/20

TESTS AND REQUIREMENTS

Essentially all tests are carried out in accordance with the schedule of "IEC publications 60115-1 and 60115-4", category 40/200/56 (rated temperature range $-40\text{ }^{\circ}\text{C}$ to $+200\text{ }^{\circ}\text{C}$; damp heat, long term, 56 days). The testing also covers the requirements specified by EIA and EIAJ.

The tests are carried out in accordance with IEC publication 60068, "Recommended basic climatic and mechanical robustness testing procedure for electronic components" and under standard atmospheric conditions according to "IEC 60068-1", subclause 5.3.

In Table 5 the tests and requirements are listed with reference to the relevant clauses of "IEC publications 60115-1, 115-4 and 68"; a short description of the test procedure is also given. In some instances deviations from the IEC recommendations were necessary for our method of specifying.

All soldering tests are performed with mildly activated flux.

Table 5 Test procedures and requirements

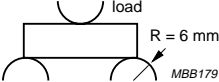
IEC 60115-1 CLAUSE	IEC 60068 TEST METHOD	TEST	PROCEDURE	REQUIREMENTS
Tests in accordance with the schedule of IEC publication 60115-1				
4.15		robustness of resistor body	load $200 \pm 10\text{ N}$ 	no visible damage $\Delta R/R$ max.: $\pm 0.5\% + 0.05\ \Omega$
4.16	U Ua Ub Uc	robustness of terminations: tensile all samples bending half number of samples torsion other half of samples	load 10 N ; 10 s load 5 N 90° , 180° , 90° $2 \times 180^{\circ}$ in opposite directions	no visible damage $\Delta R/R$ max.: $\pm 0.5\% + 0.05\ \Omega$
4.17	Ta	solderability	2 s ; $235\text{ }^{\circ}\text{C}$; flux 600	good tinning; no damage
4.18	Tb	resistance to soldering heat	thermal shock: 3 s ; $350\text{ }^{\circ}\text{C}$; 2.5 mm from body	$\Delta R/R$ max.: $\pm 0.5\% + 0.05\ \Omega$
4.19	14 (Na)	rapid change of temperature	30 minutes at $-40\text{ }^{\circ}\text{C}$ and 30 minutes at $+200\text{ }^{\circ}\text{C}$; 5 cycles	no visible damage $\Delta R/R$ max.: $\pm 1\% + 0.05\ \Omega$
4.22	Fc	vibration	frequency 10 to 500 Hz ; displacement 0.75 mm or acceleration 10 g ; 3 directions; total 6 hours ($3 \times 2\text{ hours}$)	no damage $\Delta R/R$ max.: $\pm 0.5\% + 0.05\ \Omega$
4.20	Eb	bump	4000 ± 10 bumps; 390 m/s^2	no damage $\Delta R/R$ max.: $\pm 0.5\% + 0.05\ \Omega$

Cemented wirewound resistors

AC01/03/04/05/07/10/15/20

IEC 60115-1 CLAUSE	IEC 60068 TEST METHOD	TEST	PROCEDURE	REQUIREMENTS
4.23		climatic sequence:		
4.23.2	Ba	dry heat	16 hours; 200 °C	
4.23.3	Db	damp heat (accelerated) 1 st cycle	24 hours; 55 °C; 95 to 100% RH	
4.23.4	Aa	cold	2 hours; -40 °C	
4.23.5	M	low air pressure	1 hour; 8.5 kPa; 15 to 35 °C	
4.23.6	Db	damp heat (accelerated) remaining cycles	5 days; 55 °C; 95 to 100% RH	$\Delta R/R$ max.: $\pm 1\% + 0.05 \Omega$
4.24.2	3 (Ca)	damp heat (steady state)	56 days; 40 °C; 90 to 95% RH; dissipation $\leq 0.01 P_n$	no visible damage $\Delta R/R$ max.: $\pm 1\% + 0.05 \Omega$
4.8.4.2		temperature coefficient	at 20/-40/20 °C, 20/200/20 °C: $R < 10 \Omega$ $R \geq 10 \Omega$	$TC \leq \pm 600 \times 10^{-6}/K$ $-80 \times 10^{-6} \leq TC$ $TC \leq +140 \times 10^{-6}/K$
		temperature rise	horizontally mounted, loaded with P_n	hot-spot temperature less than maximum body temperature
4.13		short time overload	room temperature; dissipation $10 \times P_n$; 5 s (voltage not more than 1000 V/25 mm)	$\Delta R/R$ max.: $\pm 2\% + 0.1 \Omega$
4.25.1		endurance (at 40 °C)	1000 hours loaded with P_n ; 1.5 hours on and 0.5 hours off	no visible damage $\Delta R/R$ max.: $\pm 5\% + 0.1 \Omega$
4.25.1		endurance (at 70 °C)	1000 hours loaded with $0.9P_n$; 1.5 hours on and 0.5 hours off	no visible damage $\Delta R/R$ max.: $\pm 5\% + 0.1 \Omega$
4.23.2	27 (Ba)	endurance at upper category temperature	1000 hours; 200 °C; no load	no visible damage $\Delta R/R$ max.: $\pm 5\% + 0.1 \Omega$
Other tests in accordance with IEC 60115 clauses and IEC 60068 test method				
4.29	45 (Xa)	component solvent resistance	70% 1.1.2 trichlorotrifluoroethane and 30% isopropyl alcohol; H ₂ O	no visible damage
4.18	20 (Tb)	resistance to soldering heat	10 s; 260 \pm 5 °C; flux 600	$\Delta R/R$ max.: $\pm 0.5\% + 0.05 \Omega$
4.17	20 (Tb)	solderability (after ageing)	16 hours steam or 16 hours at 155 °C; 2 \pm 0.5 s in solder at 235 \pm 5 °C; flux 600	good tinning ($\geq 95\%$ covered); no damage
4.5		tolerance on resistance	applied voltage ($\pm 10\%$): $R < 10 \Omega$: 0.1 V $10 \Omega \leq R < 100 \Omega$: 0.3 V $100 \Omega \leq R < 1 \text{ k}\Omega$: 1 V $1 \text{ k}\Omega \leq R < 10 \text{ k}\Omega$: 3 V $10 \text{ k}\Omega \leq R \leq 33 \text{ k}\Omega$: 10 V	$R - R_{nom}$: $\pm 5\%$ max.