

Current Sensor: ACS750xCA-075

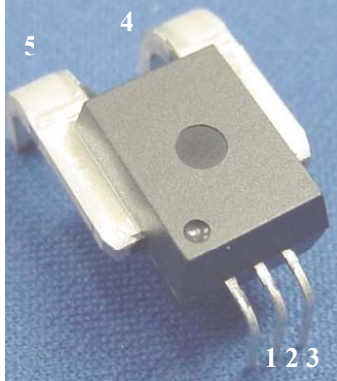

Pin 1: Vcc
Pin 2: Gnd
Pin 3: Output
Pin 4: Ip+
Pin 5: Ip-

ABSOLUTE MAXIMUM RATINGS

Operating Temperature

'S'.....	-20 to +85°C
'L'.....	-40 to +150°C
Supply Voltage, Vcc	16V
Output Voltage	16V
Output Current Source	3mA
Output Current Sink	10mA
Maximum Storage Temperature	170°C
Maximum Junction Temperature	165°C
Thermal Resistance, R _{θJA}	TBD °C/W

Always order by complete part number:

ACS750SCA-075 or
ACS750LCA-075



31Oct03, CMG, Rev 2.0

The Allegro ACS750 family of current sensors provides economical and precise solutions for current sensing in industrial, commercial, automotive, and communications systems. The device package allows for easy implementation by the customer. Typical applications include motor control, load detection and management, switched mode power supplies and over-current fault protection.

The sensor consists of a precision linear Hall IC optimized to an internal magnetic circuit to increase device sensitivity. The combination of a precisely controlled self-aligning assembly process (patents pending) and the factory programmed precision of the linear Hall sensor result in high level performance and product uniformity.

The primary conductor used for current sensing (terminals 4 and 5) is designed for extremely low power loss. The power terminals are also electrically isolated from the sensor leads (pins 1 – 3). This allows the ACS750 family of sensors to be used in applications requiring electrical isolation without the use of opto-isolators or other costly isolation techniques.

The output of the device has a positive slope ($>V_{cc}/2$) when an increasing current flows from terminal 4 to terminal 5.

Features and Benefits

- Monolithic Hall IC for High Reliability
- Single +5V Supply
- High Isolation Voltage
- Lead-free
- Automotive Temperature Range
- End-of-line Factory Trimmed for Gain and Offset
- Ultra-low Power Loss: Low Resistance of Primary Conductor
- Ratiometric Output from Supply Voltage
- Low Thermal Drift of Offset Voltage
- On-chip Transient Protection
- Small Package Size with Easy Mounting Capability

Applications

- Automotive Systems
- Industrial Systems
- Motor Control
- Servo Systems
- Power Conversion
- Battery Monitors



115 Northeast Cutoff, Box 15036
Worcester, Massachusetts 01615-0036 (508) 853-5000
Copyright © 2003, Allegro MicroSystems, Inc.

Current Sensor: ACS750xCA-075

Characteristic	Symbol	Test Conditions	Limits			
			Min.	Typ.	Max.	Units
ELECTRICAL CHARACTERISTICS, over temperature unless otherwise stated						
Primary Sensed Current	I_P		-75		75	A
Supply Voltage	V_{CC}		4.5	5.0	5.5	V
Supply Current	I_{CC}	$V_{CC} = 5.0V$, output open		7	10	mA
Output Resistance	R_{OUT}	$I_{out} = 1.2\text{ mA}$		1	2	Ω
Primary Conductor Resistance	$R_{PRIMARY}$	$I_P = \pm 100A$; $+25^\circ C$		130		$\mu\Omega$
Isolation Voltage	V_{ISO}	Pins 1-3 and 4-5, 60 Hz, 1 minute		2.5		kV
PERFORMANCE CHARACTERISTICS, $-20^\circ C$ to $+85^\circ C$, $V_{CC} = 5V$ unless otherwise specified						
Propagation time	t_{PROP}	$I_P = \pm 50A$ ($\pm 75A$ TBD)		4		μs
Response time	$t_{RESPONSE}$	$I_P = \pm 50A$ ($\pm 75A$ TBD)		27		
Rise time	t_r	$I_P = \pm 50A$ ($\pm 75A$ TBD)		26		
Frequency Bandwidth	f	-3dB		13		kHz
Sensitivity	Sens	$\pm I_P$, $T = +25^\circ C$	18.75	19.75	20.75	mV/A
		$\pm I_P$, Over Temperature	17.5		21.5	mV/A
Noise	V_{NOISE}	Peak-to-Peak; $T = +25^\circ C$ External Filter BW = 24kHz		7		mV
Non-linearity	E_L	$\pm I_P$			+/- 5	%
Symmetry	E_S	$\pm I_P$	97	100	103	%
Electrical Offset Voltage (Magnetic error not included)	V_{OE}	$I = 0A$, $T = +25^\circ C$	-40	$V_{CC}/2$	+40	mV
		$I = 0A$, Over Temperature	-50	$V_{CC}/2$	+50	mV
Magnetic Offset Error	V_{OM}	$I = 0A$, after excursion of 100A		+/- 0.3	+/- 0.8	A
Total Accuracy (Including all offsets)	X_{IP}	$\pm I_P$, $T = +25^\circ C$		+/- 1		%
		$\pm I_P$, Over Temperature			+/- 13	
PERFORMANCE CHARACTERISTICS, $-40^\circ C$ to $+150^\circ C$, $V_{CC} = 5V$ unless otherwise specified						
Propagation time	t_{PROP}	$I_P = \pm 50A$ ($\pm 75A$ TBD)		4		μs
Response time	$t_{RESPONSE}$	$I_P = \pm 50A$ ($\pm 75A$ TBD)		27		
Rise time	t_r	$I_P = \pm 50A$ ($\pm 75A$ TBD)		26		
Frequency Bandwidth	f	-3dB		13		kHz
Sensitivity	Sens	$\pm I_P$, $T = +25^\circ C$	18.75	19.75	20.75	mV/A
		$\pm I_P$, Over Temperature	16.5		23	mV/A
Noise	V_{NOISE}	Peak to Peak; $T = +25^\circ C$ External Filter BW = 40kHz		7		mV
Non-linearity	E_L	$\pm I_P$			+/- 5	%
Symmetry	E_S	$\pm I_P$	97	100	103	%
Electrical Offset Voltage (Magnetic error not included)	V_{OE}	$I = 0A$, $T = +25^\circ C$	-40	$V_{CC}/2$	+40	mV
		$I = 0A$, Over Temperature	-60	$V_{CC}/2$	+60	mV
Magnetic Offset Error	V_{OM}	$I = 0A$, after excursion of 100A		+/- 0.3	+/- 0.8	A
Total Accuracy (Including all offsets)	X_{IP}	$\pm I_P$, $T = +25^\circ C$		+/- 1		%
		$\pm I_P$, Over Temperature			+/- 15	

Current Sensor: ACS750xCA-075

Functional Block Diagram

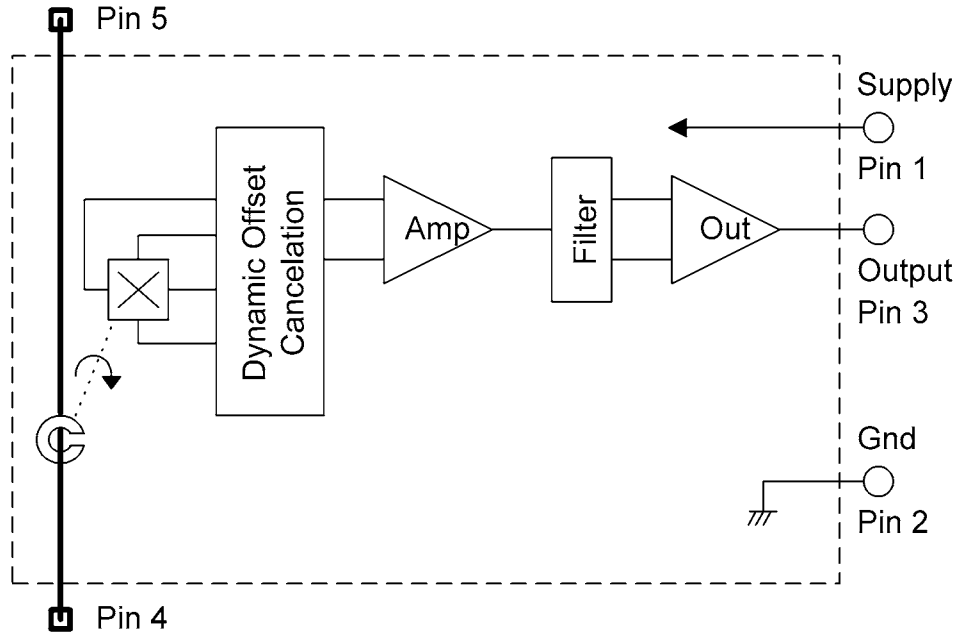

Current Sensor: ACS750xCA-075

Typical Performance Characteristics

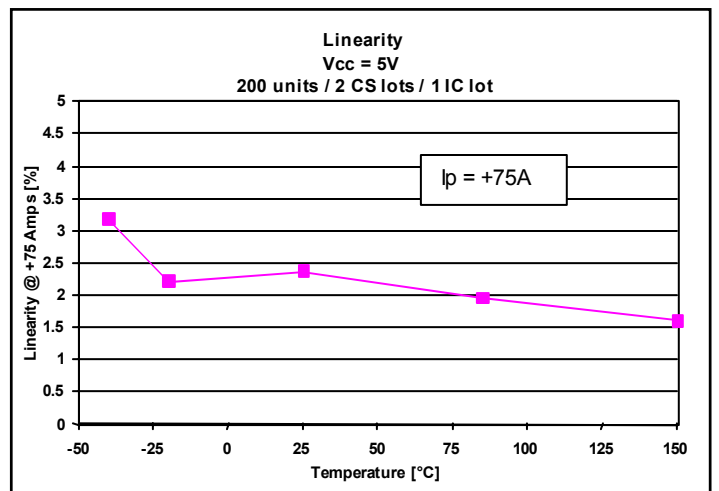
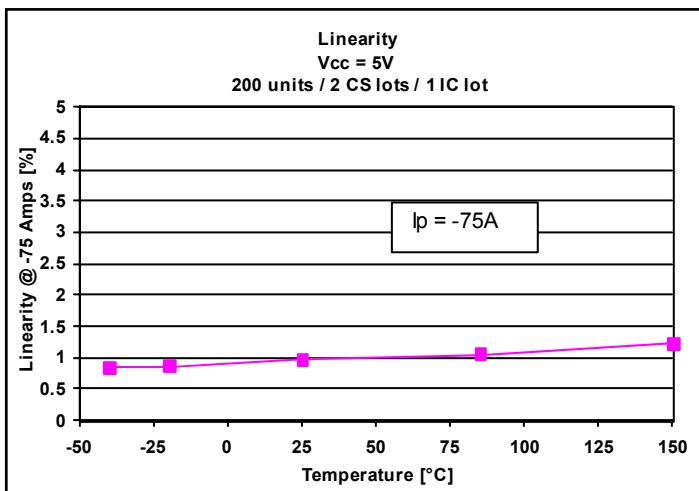
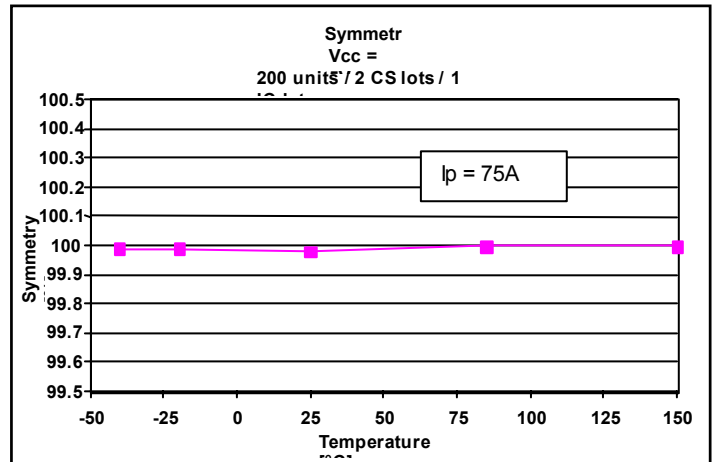
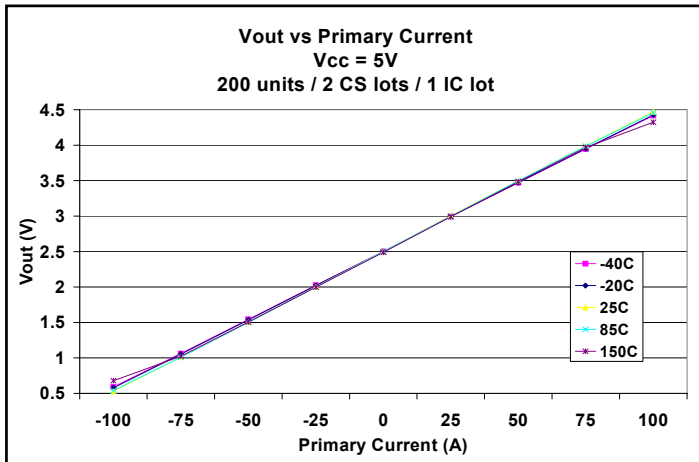
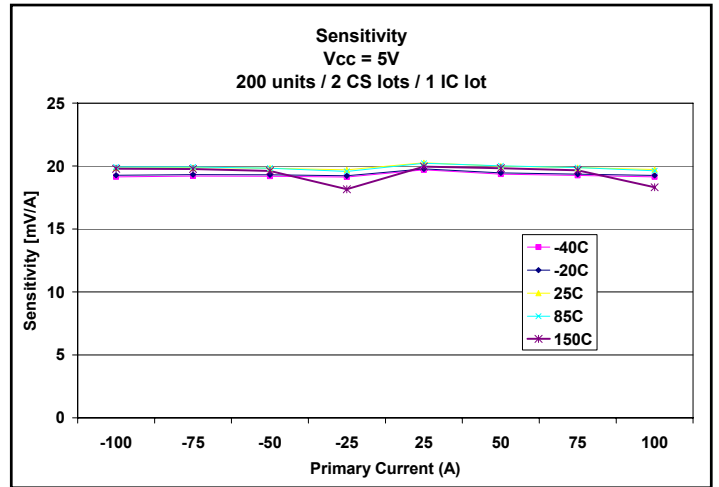
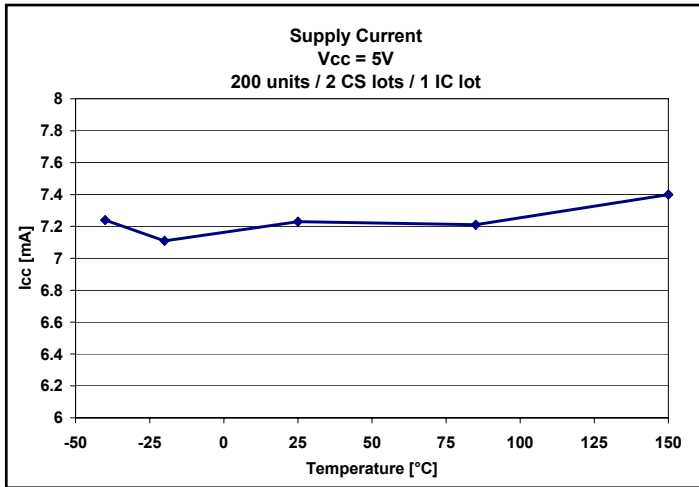

Current Sensor: ACS750xCA-075

Typical Performance Characteristics (continued)

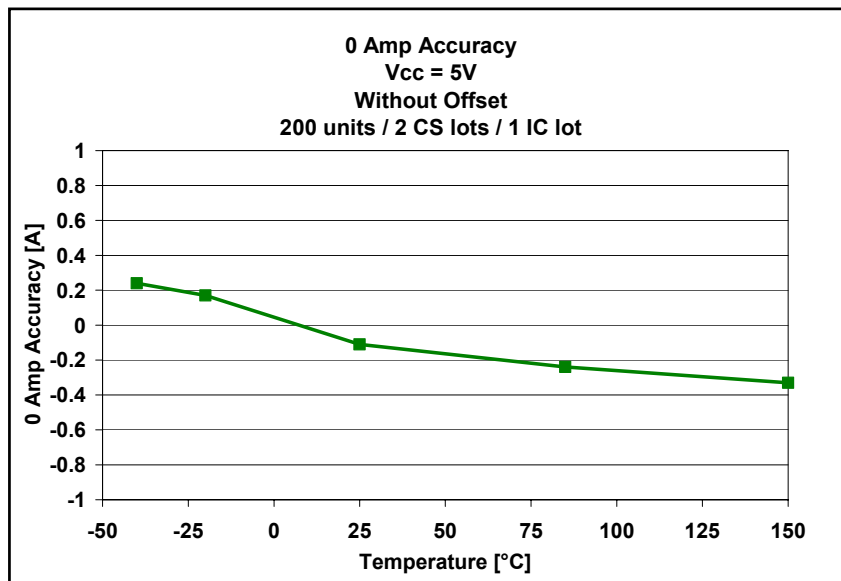
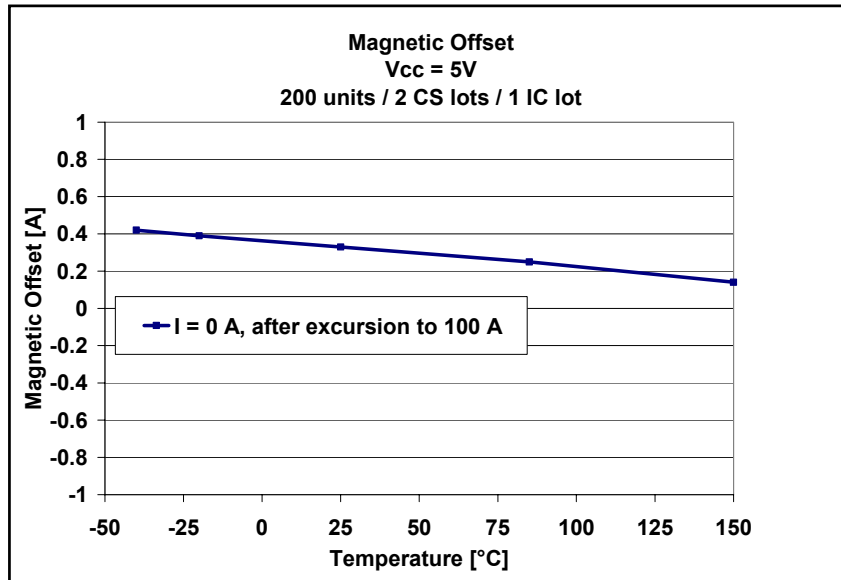

Current Sensor: ACS750xCA-075

Definitions of Accuracy Characteristics

Sensitivity: The sensitivity is the change in sensor output to 1A change through the primary conductor. The sensitivity is the product of the magnetic circuit sensitivity (G/A) and the linear IC amplifier gain (mV/G). The linear IC amplifier gain is trimmed at the factory to optimize the sensitivity (mV/A) for the full-scale current of the device.

Noise: The noise is the product of the linear IC amplifier gain (mV/G) and the noise floor for the Allegro Hall effect linear IC (~1Gauss). The noise floor is derived from the thermal and shot noise observed in Hall elements. Dividing the noise (mV) by the sensitivity (mV/A) provides the smallest current that the device is able to resolve.

Linearity: The linearity is the degree to which the voltage output from the sensor varies in direct proportion to the primary current through its full-scale amplitude. Linearity reveals the maximum deviation from the ideal transfer curve for this transducer. Non-linearity in the output can be attributed to the gain variation across temperature and saturation of the flux concentrator approaching the full scale current. The following equation is used to derive the linearity:

$$\left[1 - \frac{(V_{out_full\text{-}scale\ Amps} - V_{out_0A})}{2 * (V_{out_1/2\ full\text{-}scale\ Amps} - V_{out_0A})}\right] * 100$$

Symmetry: Symmetry is the degree to which the absolute voltage output from the sensor varies in proportion to either a positive or negative full-scale primary current. The following equation is used to derive symmetry:

$$\frac{(V_{out_full\text{-}scale\ Amps} - V_{out_0A})}{(V_{out_0A} - V_{out_full\text{-}scale\ Amps})} * 100$$

Electrical offset voltage: The quiescent output voltage (V_{OE}) is the output of the sensor when the primary current is zero. For a unipolar supply voltage, V_{OE} nominally sits at $V_{cc}/2$. $V_{cc} = 5V$ translates into $V_{OE} = 2.5V$. Variation in V_{OE} can be attributed to the resolution of the Allegro linear IC quiescent voltage trim, magnetic hysteresis, and thermal drift.

Magnetic offset error: The magnetic offset is due to the residual magnetism (remnant field) of the core material. The magnetic offset error is highest when the magnetic circuit has been saturated, usually when the device has been subjected to a full scale or high current overload condition. The magnetic offset is largely dependent on the material used as a flux concentrator. The largest magnetic offset is observed at the lowest operating temperature.

Accuracy: The accuracy represents the maximum deviation of the actual output from its ideal value. This is also known as the total error. The accuracy is illustrated graphically in Figure #1. The accuracy is divided into four areas as defined below:

- **0 A @ 25°C:** Accuracy of sensing zero current flow at 25°C, without the effects of temperature.
- **0 A over temperature:** Accuracy of sensing zero current flow including temperature effects.
- **Full-scale current @ 25°C:** Accuracy of sensing the full-scale current at 25°C, without the effects of temperature.
- **Full-scale current over temperature:** Accuracy of sensing full-scale current flow including temperature effects.

Current Sensor: ACS750xCA-075

Figure 1: Output Voltage vs. Current, illustrating sensor accuracy at 0A and full-scale current

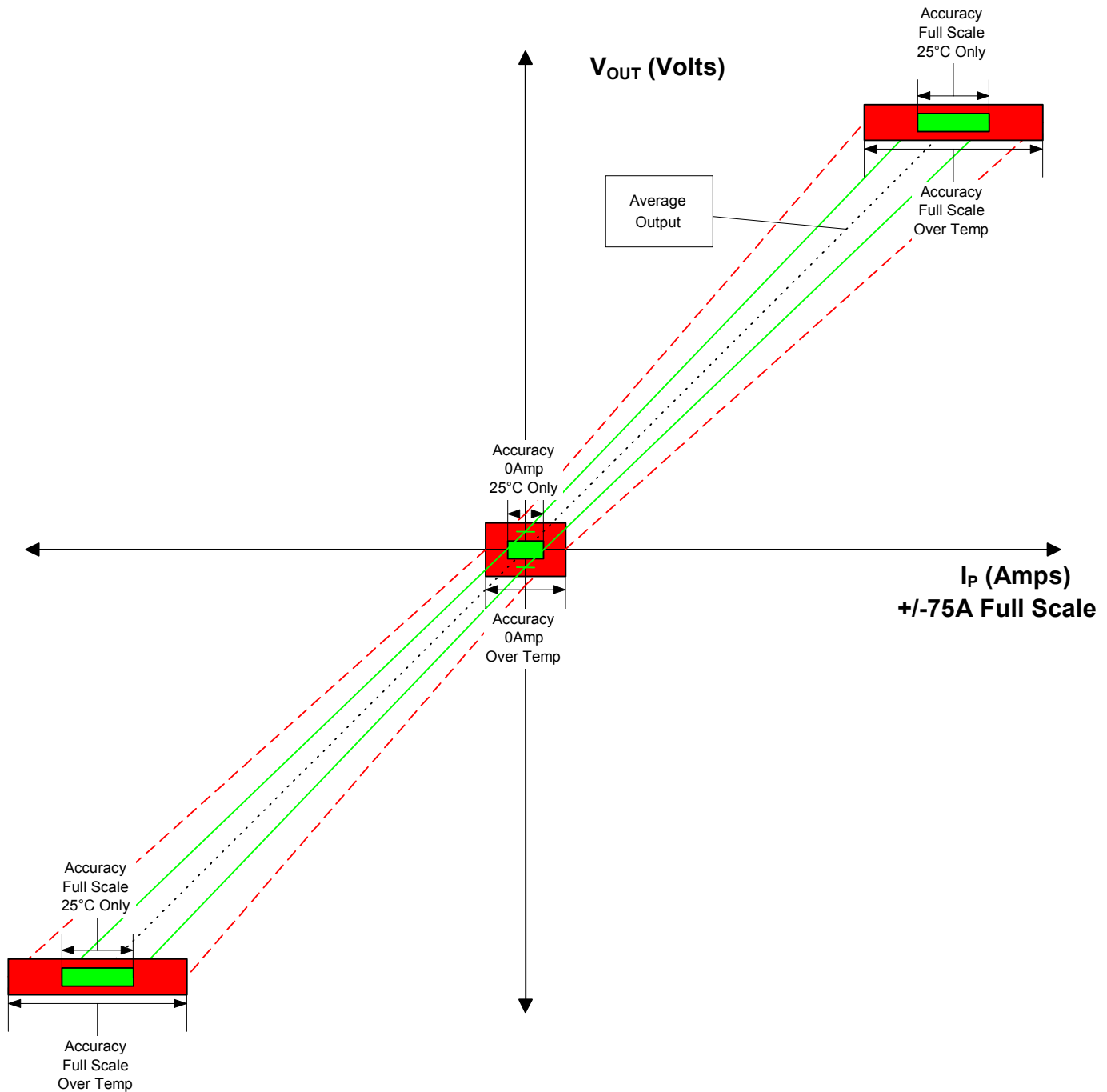

Current Sensor: ACS750xCA-075

Definitions of Dynamic Response Characteristics

Propagation delay: Propagation delay is the time that it takes for the sensor output to reflect a change in the primary current signal. Propagation delay is attributed to inductive loading within the linear IC package as well as the inductive loop formed by the primary conductor geometry. Propagation delay can be considered as a fixed time offset and may be compensated.

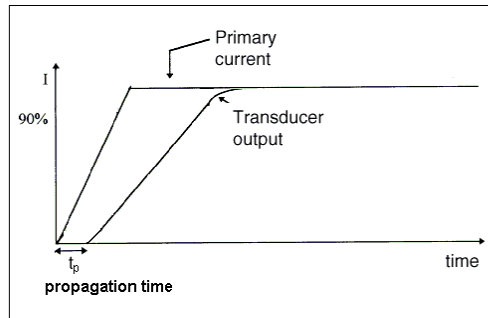

Response time: Response time is the time between when the primary current signal reaches 90% of its final value and when the sensor reaches 90% of its output corresponding to the applied current.

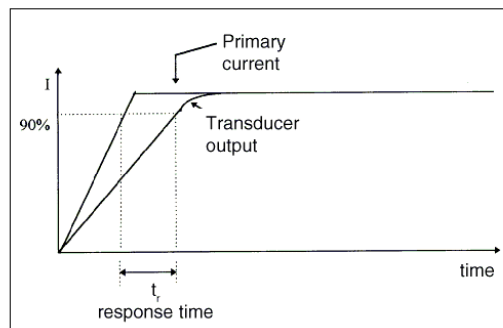

Rise time: Rise time is the time between the sensor's output reaching 10 and 90% of its full scale value. The rise time to a step response is used to derive the bandwidth of the current sensor, in which $f(-3dB) = 0.35/t_r$. Both rise time and response time are detrimentally affected by eddy current losses observed in the conductive IC ground plane and, to varying degrees, in the ferrous flux concentrator within the current sensor package.

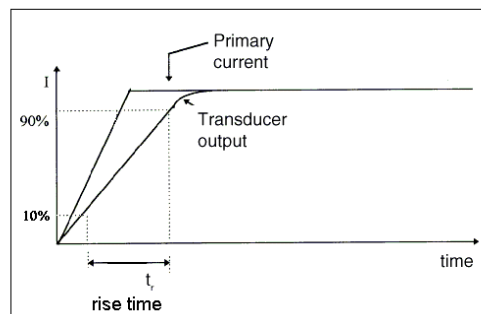

Current Sensor: ACS750xCA-075

Peak to Peak Noise, applying low-pass filter to ACS750 output

Low Pass Filter Break Frequency	Typical Peak to Peak Noise
Unfiltered	22.7 mV
1.4MHz	21 mV
400kHz	TBD
160kHz	TBD
80kHz	TBD
24kHz	7.1 mV

Step Resonance, $I_{PRIMARY} = 0$ to 50A

31-Oct-03
10:32:18

10 μ s
158mV
750mV

10 μ s
8.4 A
-1.84 A

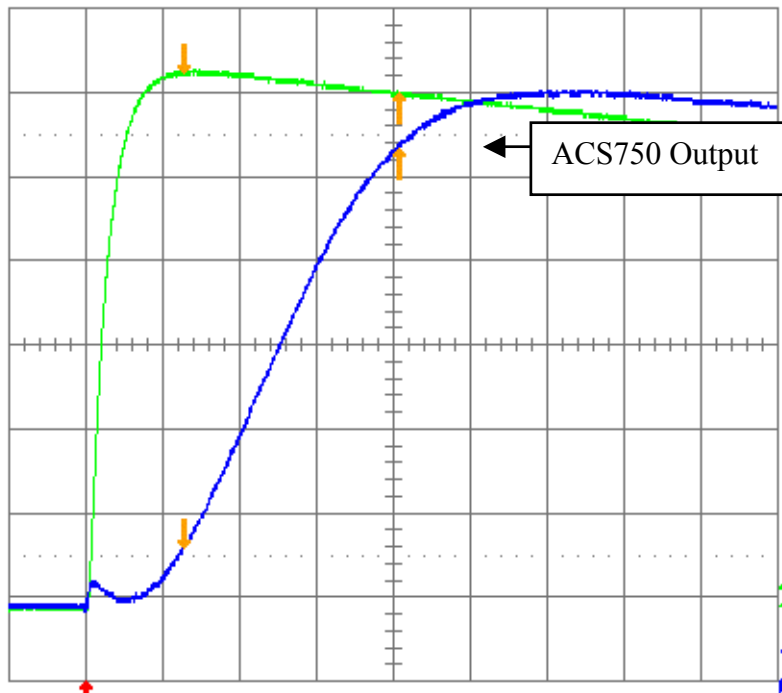

10 μ s BWL
1 15.8mV DC \times
2 .5 V DC \times
3 .5 V DC \times
4 0.84 V DC \times

Δt 27.900 μ s $\frac{1}{\Delta t}$ 35.842 kHz

2 DC 3.0 V

1 GS/s

STOPPED

Current Sensor: ACS750xCA-075

PACKAGE DRAWING

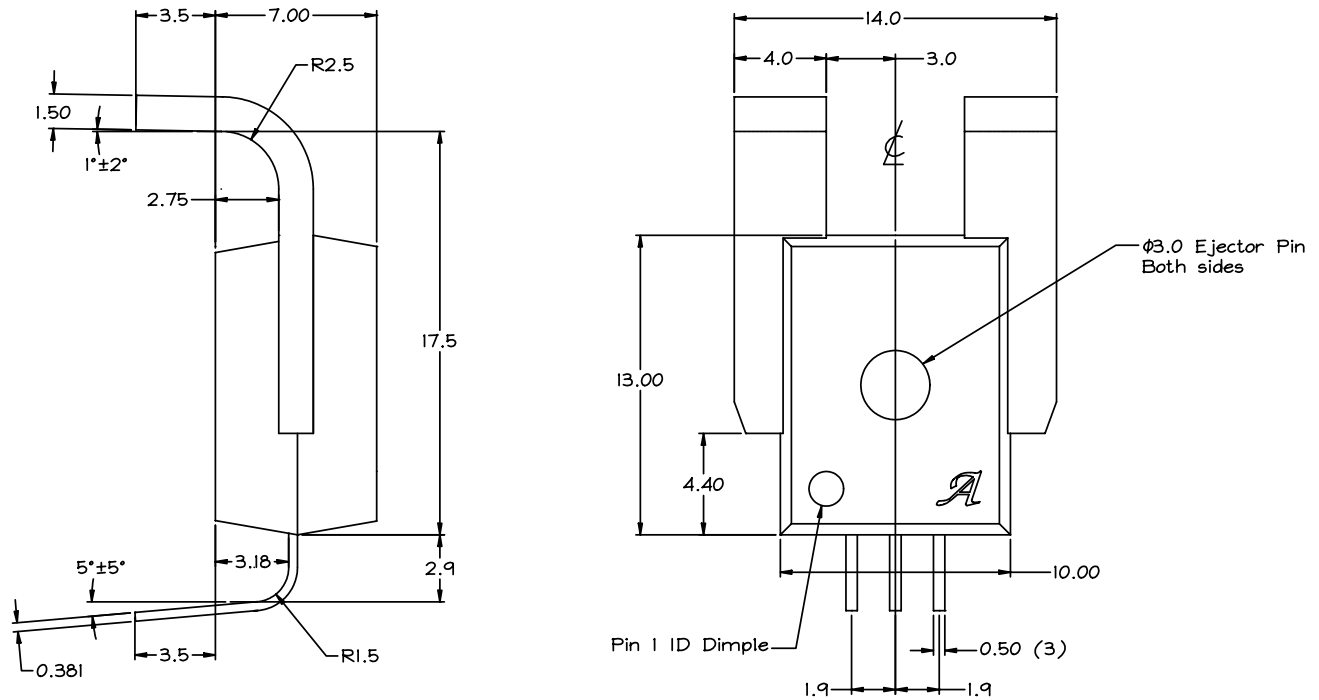

Notes:

1. This drawing is only a preliminary issue and no tolerances are implied to any dimensions.
2. Draft angle is 10° unless otherwise specified.
3. There is no plating in areas that are trimmed.
4. SIP lead flash along the edge or sides for 3mm from the package due to resin bleeding.

Current Sensor: ACS750xCA-075

The products described herein are manufactured under one or more of the following U.S. patents: 5,045,920; 5,264,783; 5,442,283; 5,389,889; 5,581,179; 5,517,112; 5,619,137; 5,621,319; 5,650,719; 5,686,894; 5,694,038; 5,729,130; 5,917,320; and other patents pending.

Allegro MicroSystems, Inc. reserves the right to make, from time to time, such departures from the detail specifications as may be required to permit improvements in the performance, reliability, or manufacturability of its products. Before placing an order, the user is cautioned to verify that the information being relied upon is current.

Allegro products are not authorized for use as critical components in life-support appliances, devices, or systems without express written approval.

The information included herein is believed to be accurate and reliable. However, Allegro MicroSystems, Inc. assumes no responsibility for its use; nor for any infringements of patents or other rights of third parties that may result from its use.