



ACST8

ASD™
(AC Switch Family)

OVER VOLTAGE PROTECTED AC POWER SWITCH

MAIN APPLICATIONS

- AC static switching in appliance & industrial control systems
- Washing machine with bi-rotational induction motor drive
- Induction motor drive for:
 - refrigerator / freezer compressor
 - air conditioning compressor

FEATURES

- $V_{DRM} / V_{RRM} = +/- 800V$
- Avalanche controlled device
- $I_{T(RMS)} = 8A$ with $T_{CASE} = 90\text{ }^{\circ}C$
- High noise immunity: static $dV/dt > 750\text{ V}/\mu s$
- Gate triggering current : $I_{GT} < 30\text{ mA}$
- Snubberless turn off commutation: $(di/dt)_c > 4.5A/ms$

BENEFITS

- Enables equipment to meet EN61000-4-5 standard
- High off-state reliability with planar technology
- Need no external overvoltage protection
- Reduces the power component count

DESCRIPTION

The ACST8-8C belongs to the AC power switch family built around the ASD™ technology. This high performance device is adapted to home appliances or industrial systems and drives an induction motor up to 8A.

This ACST switch embeds a triac structure with a high voltage clamping device to absorb the inductive turn off energy and withstand line transients such as those described in the IEC61000-4-5 standards.

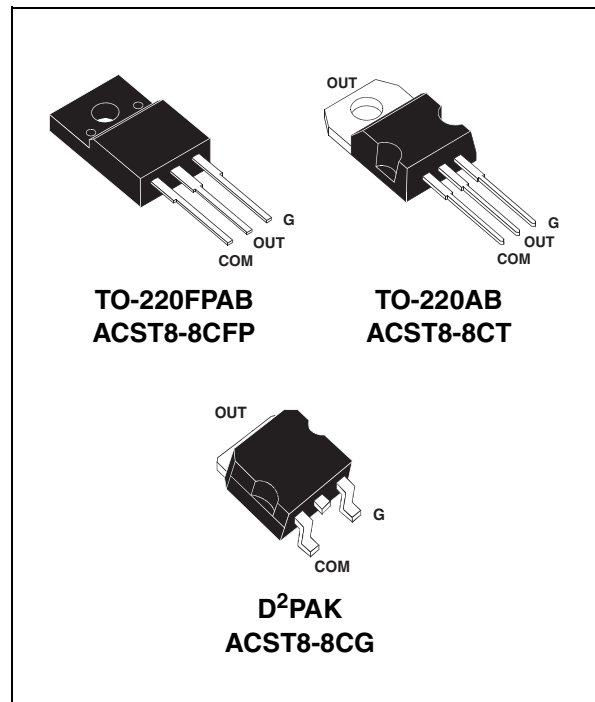
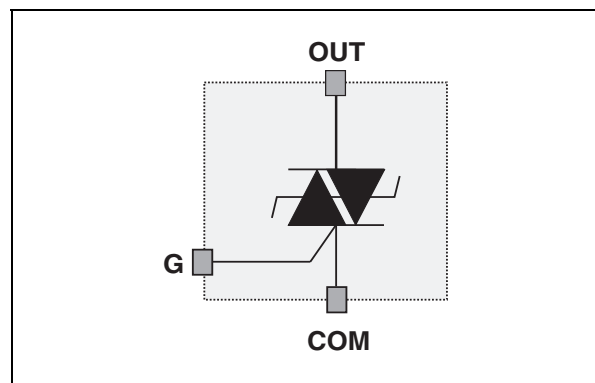

Table 1: Order Codes

Part Number	Marking
ACST8-8CFP	ACST88C
ACST8-8CT	
ACST8-8CG	

Figure 1: Functional Diagram



TM: ASD is a trademark of STMicroelectronics.

Table 2: Absolute Ratings (limiting values)

Symbol	Parameter		Value	Unit	
$I_{T(RMS)}$	RMS on-state current full cycle sine wave 50 to 60 Hz	TO-220FPAB	$T_{case} = 90^{\circ}C$	8	A
		TO-220AB / D ² PAK	$T_{case} = 100^{\circ}C$	8	
I_{TSM}	Non repetitive surge peak on-state current T_j initial = 25°C, full cycle sine wave		$t_p = 20ms$	80	A
			$t_p = 16.7ms$	85	A
I^2t	Thermal constraint for fuse selection		$t_p = 10ms$	35	A ² s
di/dt	Non repetitive on-state current critical rate of rise $I_G = 10mA$ ($t_r < 100ns$)		Rate period > 1mn	100	A/ μs
V_{PP}	Non repetitive line peak pulse voltage		note 1	2	kV
T_{stg}	Storage temperature range			- 40 to + 150	°C
T_j	Operating junction temperature range			- 40 to + 125	°C
T_l	Maximum lead soldering temperature during 10s			260	°C

Note 1: according to test described by IEC61000-4-5 standard & figure A.

Table 3: Gate Characteristics (maximum values)

Symbol	Parameter	Value	Unit
$P_G (AV)$	Average gate power dissipation	0.1	W
P_{GM}	Peak gate power dissipation ($t_p = 20\mu s$)	10	W
I_{GM}	Peak gate current ($t_p = 20\mu s$)	1	A

Table 4: Thermal Resistance

Symbol	Parameter		Value	Unit
$R_{th(j-a)}$	Junction to ambient	TO-220FPAB TO-220AB	60	°C/W
$R_{th(j-a)}$	Junction to ambient (soldered on 1 cm ² copper pad)	D ² PAK	45	°C/W
$R_{th(j-c)}$	Junction to case for full cycle sine wave conduction	TO-220FPAB	3.5	°C/W
$R_{th(j-c)}$	Junction to case for full cycle sine wave conduction	TO-220AB D ² PAK	2.5	°C/W

Table 5: Parameter Description

Parameter Symbol	Parameter description
I_{GT}	Gate triggering current
V_{GT}	Gate triggering voltage
V_{GD}	Non triggering voltage
I_H	Holding current
I_L	Latching current
V_{TM}	On state voltage
V_{T0}	On state characteristic threshold voltage
R_d	On state characteristic dynamic resistance
I_{DRM} / I_{RRM}	Forward or reverse leakage current
dV/dt	Static pin OUT voltage rise
$(di/dt)_c$	Turn off current rate of decay
V_{CL}	Avalanche voltage at turn off

Table 6: Electrical Characteristics per Switch

For either positive or negative polarity of pin OUT voltage respect to pin COM voltage

Symbol	Test conditions			Values	Unit
V_{DRM}/V_{RRM}	Repetitive peak off-state voltage		MAX.	800	V
I_{GT}	$V_{OUT} = 12V$ (DC) $R_L = 33\Omega$	$T_j = 25^\circ C$	MAX.	30	mA
V_{GT}	$V_{OUT} = 12V$ (DC) $R_L = 33\Omega$	$T_j = 25^\circ C$	MAX.	1.5	V
V_{GD}	$V_{OUT} = V_{DRM}$ $R_L = 3.3k\Omega$	$T_j = 125^\circ C$	MIN.	0.2	V
I_H	$I_{OUT} = 100mA$ Gate open	$T_j = 25^\circ C$	MAX.	40	mA
I_L	$I_G = 20mA$	$T_j = 25^\circ C$	MAX.	70	mA
V_{TM}	$I_{OUT} = 11A$ $t_p = 380\mu s$	$T_j = 25^\circ C$	MAX.	1.5	V
V_{T0}		$T_j = 125^\circ C$	MAX.	0.95	V
R_d		$T_j = 125^\circ C$	MAX.	50	m Ω
I_{DRM}/I_{RRM}	$V_{OUT} = V_{DRM}$ $V_{OUT} = V_{RRM}$	$T_j = 25^\circ C$	MAX.	10	μA
		$T_j = 125^\circ C$	MAX.	1	mA
dV/dt	$V_{OUT} = 550V$ gate open	$T_j = 125^\circ C$	MIN.	750	V/ μs
(dI/dt) _c	Without snubber	$T_j = 125^\circ C$	MIN.	4.5	A/ms
V_{CL}	$I_{CL} = 1mA$ $t_p = 1ms$	$T_j = 25^\circ C$	TYP.	1200	V

1. AC LINE SWITCH BASIC APPLICATION

The ACST8-8C device is especially designed to drive medium power induction motors in washing machines, refrigerators, dish washers, and tumble dryers.

Pin COM : Common drive reference, to be connected to the power line neutral

Pin G : Switch Gate input to be connected to the controller

Pin OUT : Switch Output to be connected to the load

When driven from a low voltage controller, the ACST switch is triggered with a negative gate current flowing out of the gate pin G. It can be driven by the controller through a resistor as shown on the typical application diagram. In appliance systems, the ACST8-8C switch intends to drive medium power load in ON / OFF full cycle or phase angle control mode.

Thanks to its thermal and turn-off commutation characteristics, the ACST8-8C switch is able to drive an inductive load up to 8A without a turn-off aid snubber circuit.

In washing machine or drier appliances, the tumble rotates in both directions. When using bidirectional phase shift induction motor, two switches are connected on each side of the phase shift capacitor: in steady-state operation, one switch only conducts energising the coils and defining the tumble direction.

Figure 2: Typical Application Diagram

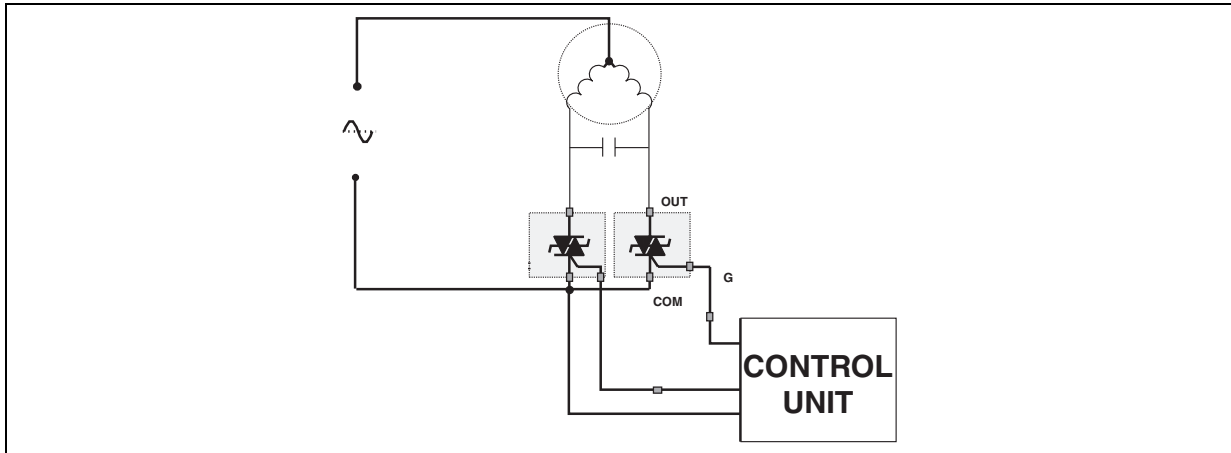

2. ROBUSTNESS AGAINST FAST CAPACITOR DISCHARGE

When parasitic transients or controller mis-operation occur, the blocked switch may turn on by spurious switch firing. Since the phase shift capacitor is charged, its energy is instantaneously dissipated through the two ACSTs which can be destroyed. To prevent such a failure, a resistive inductive circuit R-L is added in series with the phase shift capacitor.

The di/dt depends on the maximal voltage V_{max} of the phase shift capacitor (700V on 240V mains applications), and on the inductance L:

$$\frac{di}{dt} = \frac{V_{max}}{L}$$

The total switch turn on di/dt is the sum of the di/dt created by any RC noise suppressor discharge and the di/dt created by the motor capacitor discharge.

Since the maximal di/dt capability at turn-on of the ACST8 is $100A/\mu s$, the motor capacitor di/dt is assumed to be less than $50A/\mu s$; therefore, the inductance should be $14\mu H$.

The resistor R limits the surge current through the ACST8 during the capacitor discharge according to the specified curve $I_{TSM} = f(tp)$ as shown in figure 11 (*to be issued*), and 1.2Ω is low enough to limit the resistor dissipation (usually less than 1 W).

Finally both the $14\mu H$ inductance and the 1.2Ω resistance provide a safety margin of two on the surge current I_{TSM} described in figure 11.

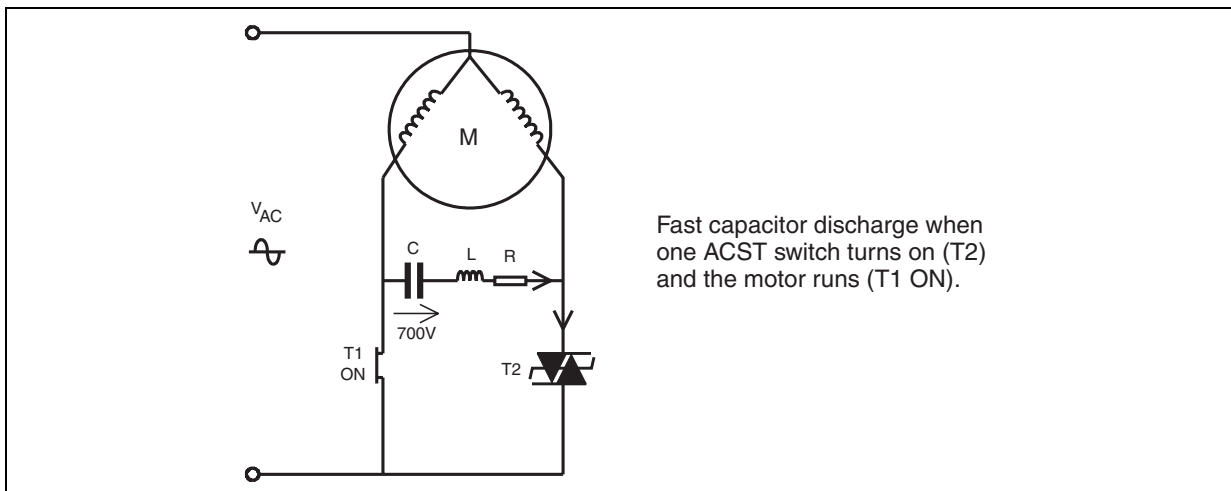

3. AC LINE TRANSIENT VOLTAGE RUGGEDNESS

The ACST8-8C switch is able to safely withstand the AC line transient voltages either by clamping the low energy spikes or by breaking over under high energy shocks.

The test circuit in figure 3 is representative of the ACST application and is used to test the ACST switch according to the IEC61000-4-5 standard conditions. Thanks to the load impedance, the ACST switch withstands voltage spikes up to 2 kV above the peak line voltage by breaking over safely. Such non repetitive testing can be done 10 times on each AC line voltage polarity.

Figure 3: Overvoltage ruggedness test circuit for resistive and inductive loads according to IEC61000-4-5 standard $R = 47\Omega$, $L = 10\mu H$ & $V_{PP} = 2kV$

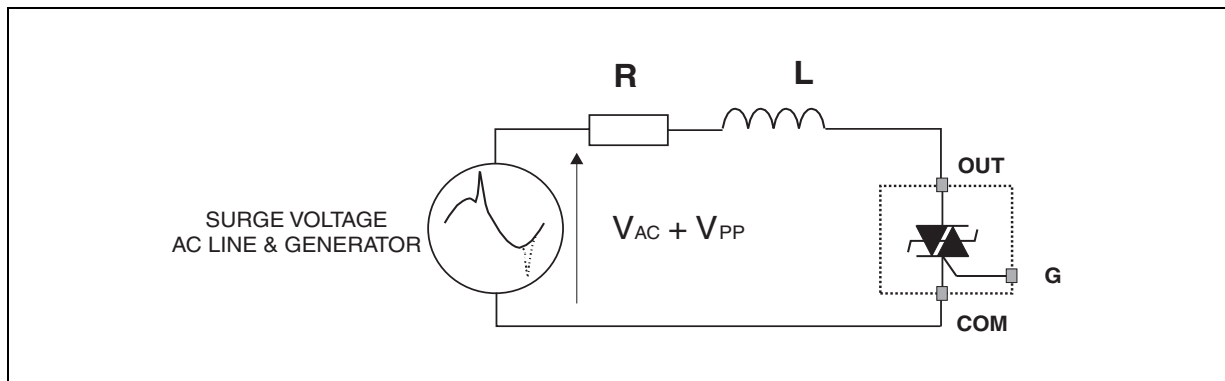

Figure 4: Maximum power dissipation versus RMS on-state current

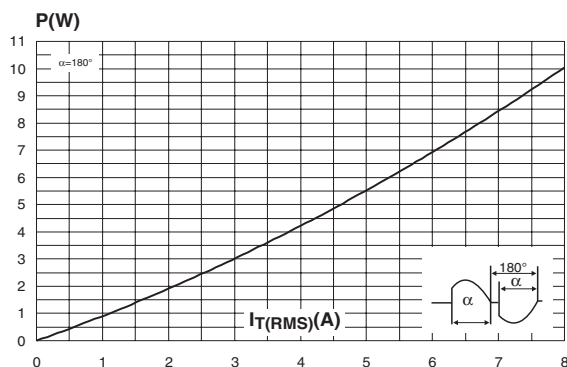

Figure 6: RMS on-state current versus ambient temperature

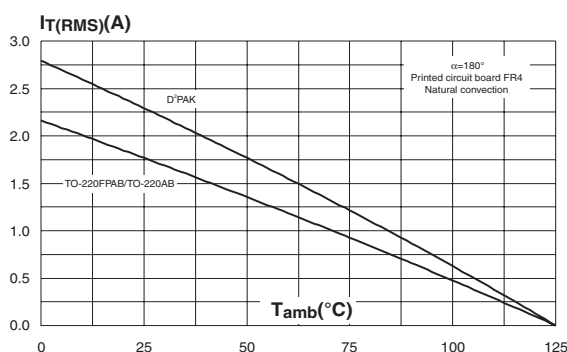

Figure 5: RMS on-state current versus case temperature

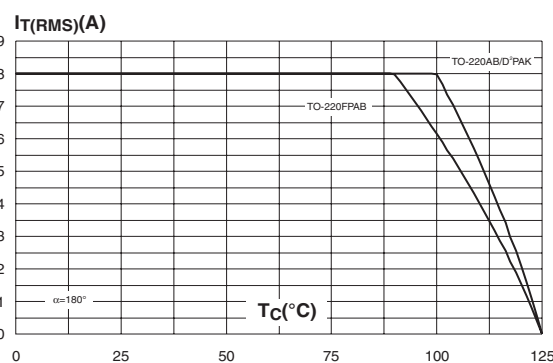

Figure 7: Relative variation of thermal impedance versus pulse duration (TO-220FPAB)

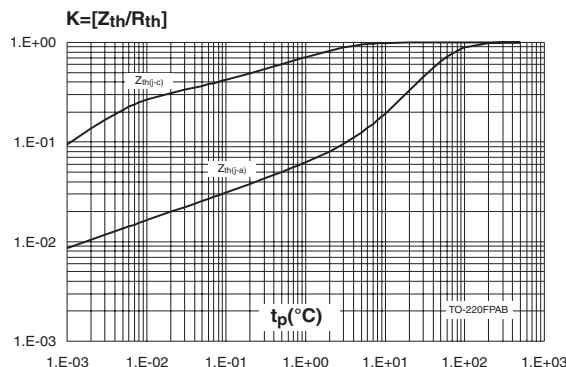

Figure 8: Relative variation of thermal impedance versus pulse duration (TO-220AB / D²PAK)

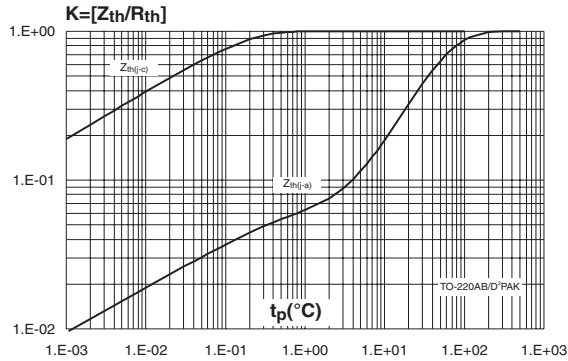

Figure 9: On-state characteristics (maximum values)

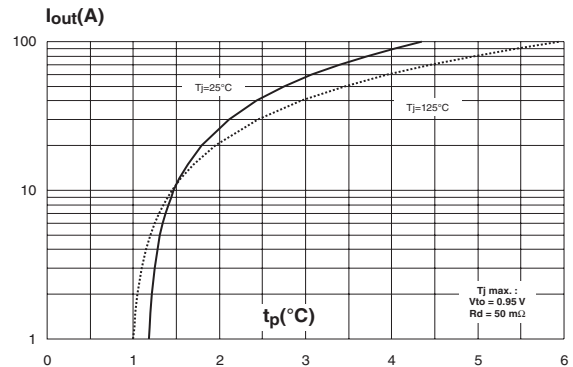

Figure 10: Surge peak on-state current versus number of cycles

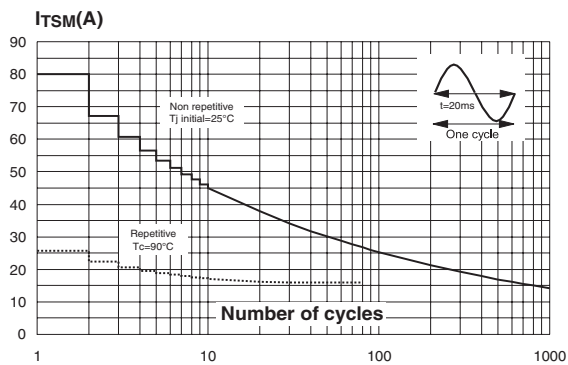

Figure 11: Non repetitive surge peak on-state current for a sinusoidal pulse with width tp < 10ms, and corresponding value of I²t

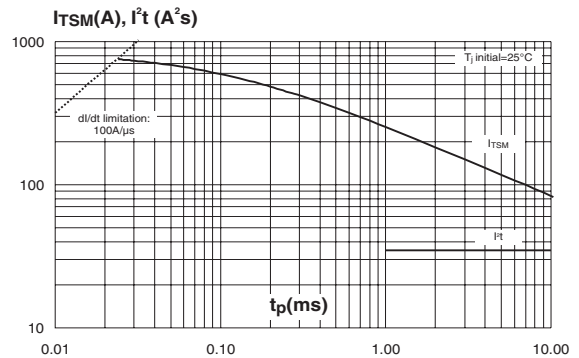

Figure 12: Relative variation of gate trigger current, holding current and latching current versus junction temperature (typical values)

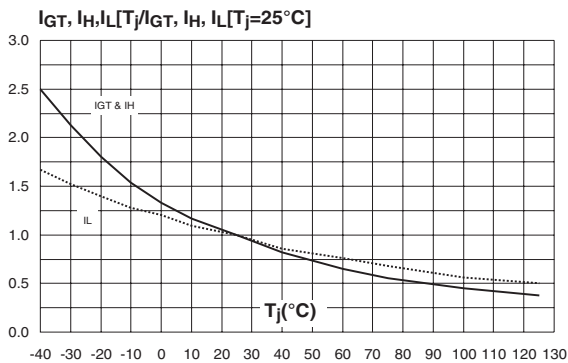

Figure 13: Relative variation of critical rate of decrease of main current versus reapplied dV/dt (typical values)

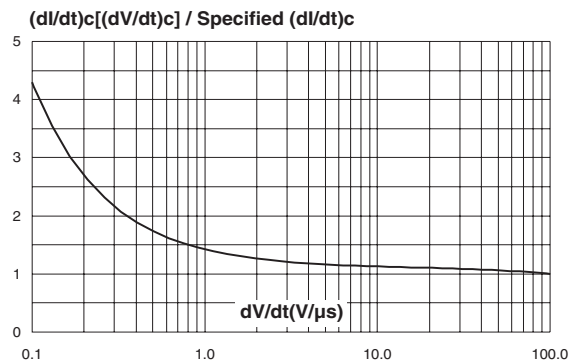

Figure 14: Relative variation of critical rate of decrease of main current versus junction temperature

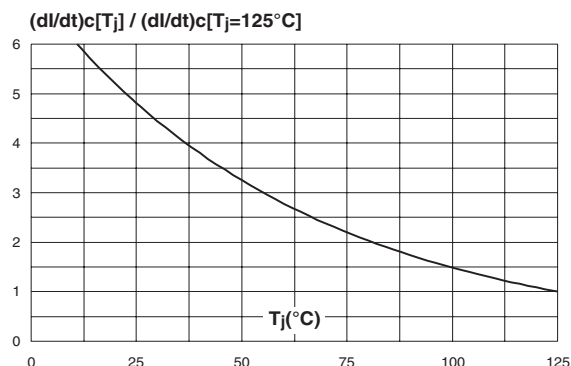

Figure 15: Relative variation of static dV/dt versus junction temperature

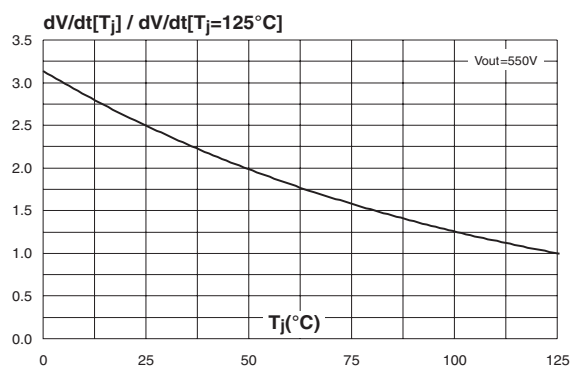

Figure 16: Surge peak on-state current versus number of cycles

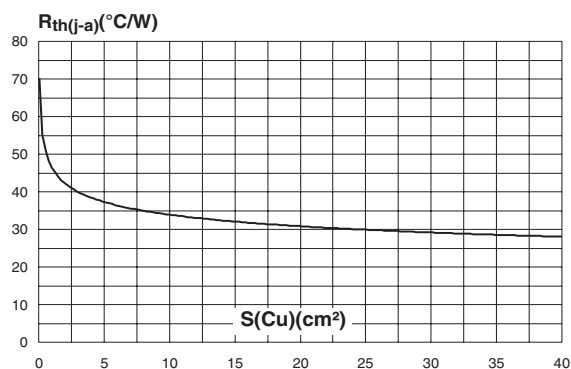

Figure 17: Ordering Information Scheme

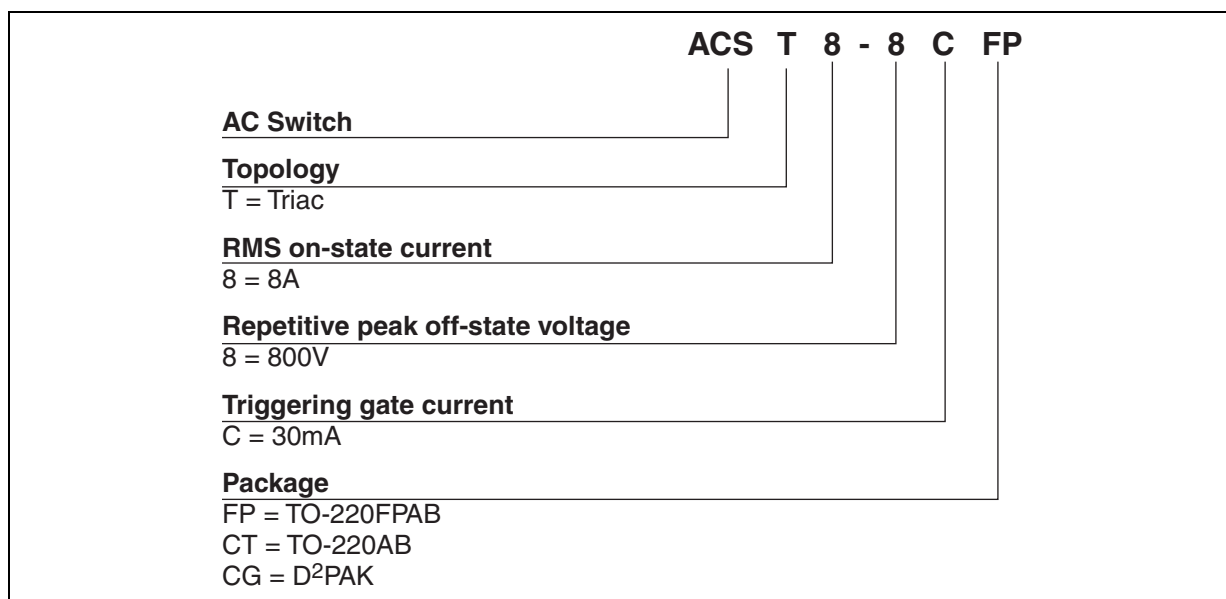

Figure 18: TO-220AB Package Mechanical Data

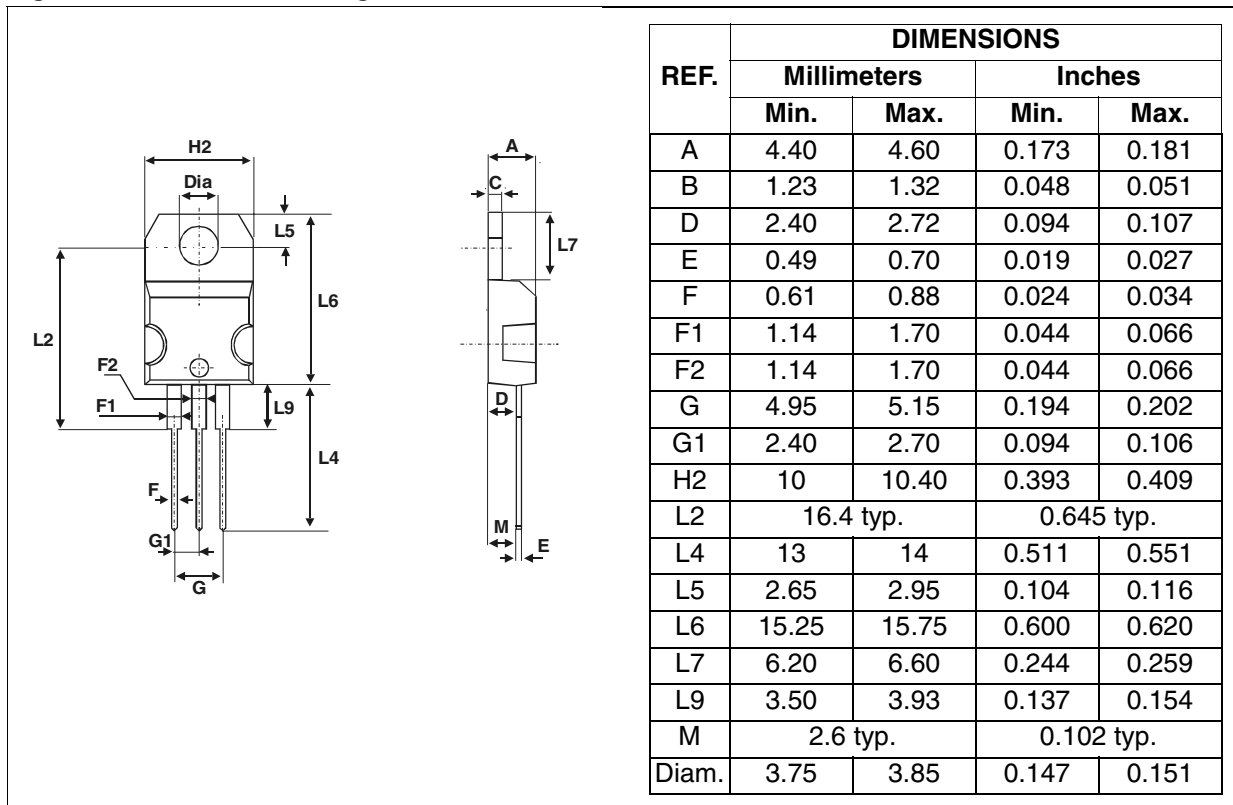

Figure 19: TO-220FPAB Package Mechanical Data

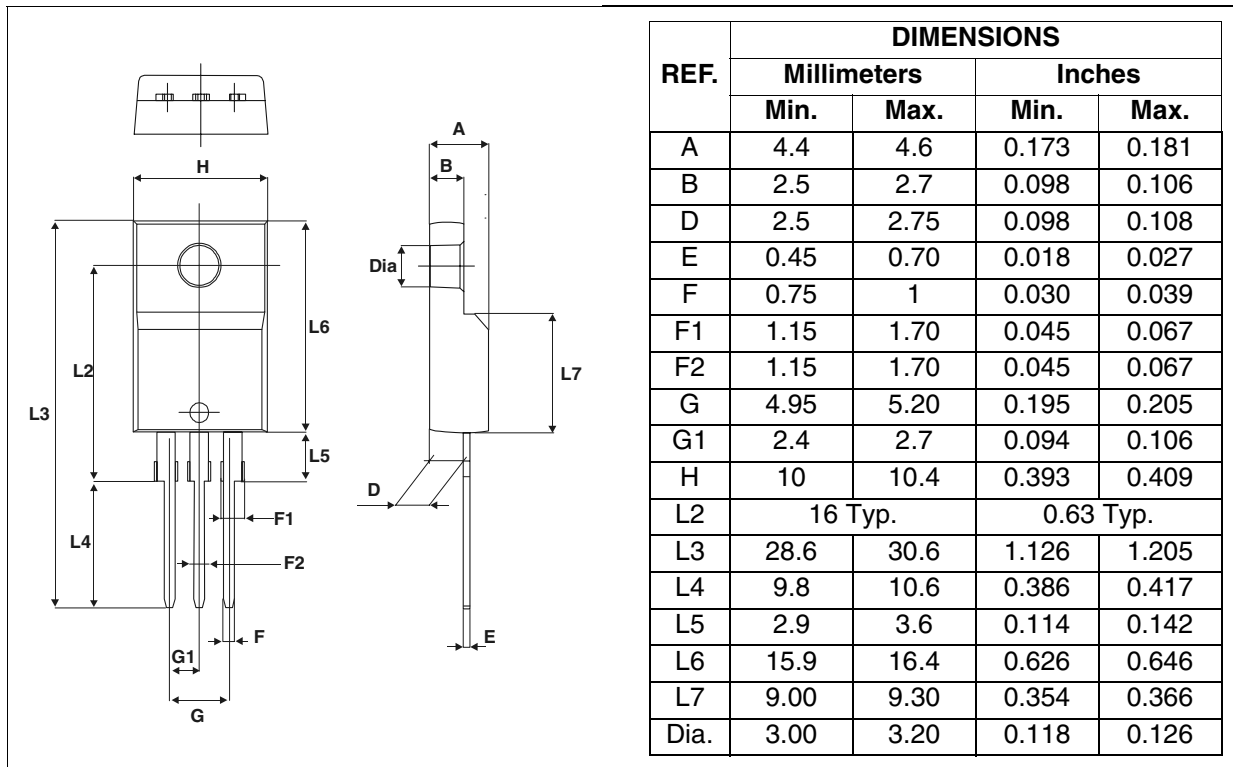

Figure 20: D²PAK Package Mechanical Data

Figure 21: Foot Print Dimensions

(in millimeters)

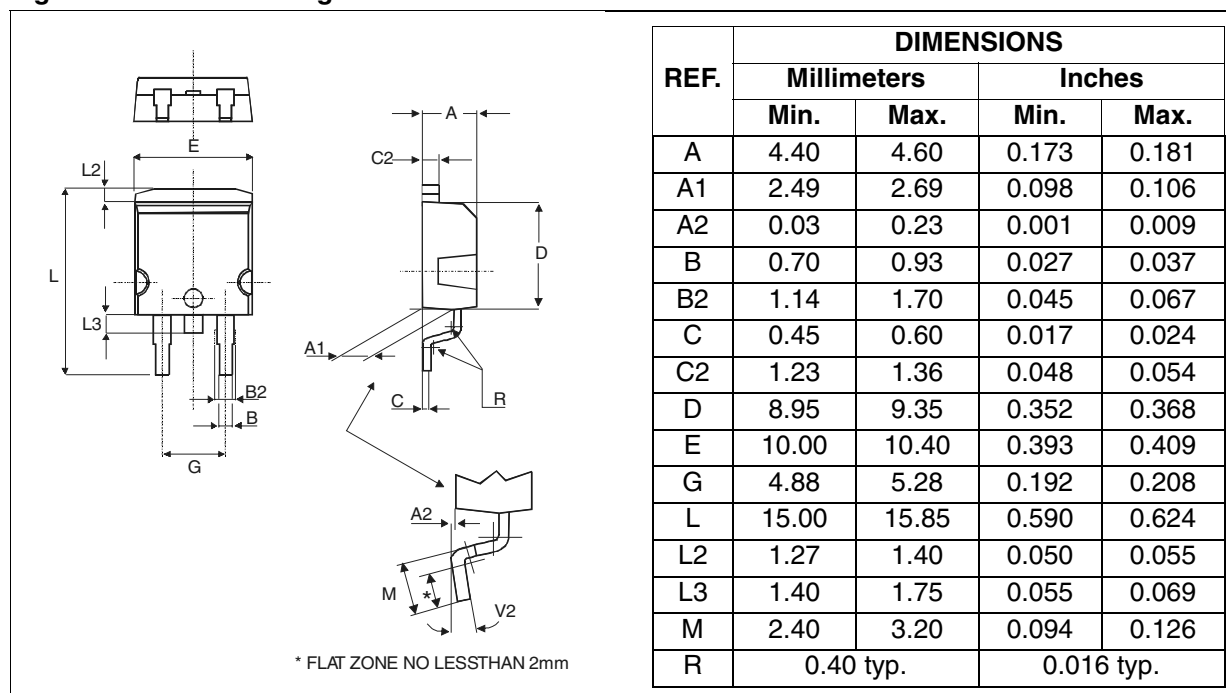
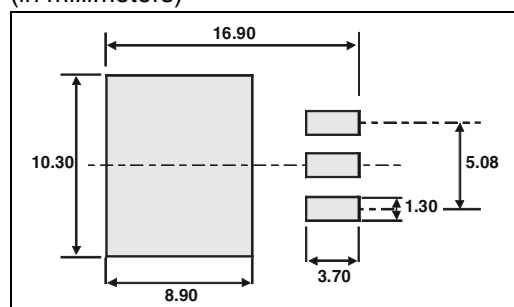

Table 7: Ordering Information

Part Number	Marking	Package	Weight	Base qty	Delivery mode
ACST8-8CFP	ACST88C	TO-220FPAB	2.4 g	50	Tube
ACST8-8CT		TO-220AB	2.3 g	50	Tube
ACST8-8CG		D ² PAK	1.5 g	50	Tube
ACST8-8CG-TR			500	Tape & reel	

■ Epoxy meets UL94, V0

Table 8: Revision History

Date	Revision	Description of Changes
Jan-2002	4B	Last update.
08-Nov-2004	5	TO-220AB and D ² PAK packages added.
24-Nov-2004	6	Table 6 page 3 : I _{GT} parameter added

Information furnished is believed to be accurate and reliable. However, STMicroelectronics assumes no responsibility for the consequences of use of such information nor for any infringement of patents or other rights of third parties which may result from its use. No license is granted by implication or otherwise under any patent or patent rights of STMicroelectronics. Specifications mentioned in this publication are subject to change without notice. This publication supersedes and replaces all information previously supplied. STMicroelectronics products are not authorized for use as critical components in life support devices or systems without express written approval of STMicroelectronics.

The ST logo is a registered trademark of STMicroelectronics.
All other names are the property of their respective owners

© 2004 STMicroelectronics - All rights reserved

STMicroelectronics group of companies

Australia - Belgium - Brazil - Canada - China - Czech Republic - Finland - France - Germany - Hong Kong - India - Israel - Italy - Japan -
Malaysia - Malta - Morocco - Singapore - Spain - Sweden - Switzerland - United Kingdom - United States of America
www.st.com