

### FEATURES

**Linear-in-dB gain control**

**Pin programmable gain ranges**

–11 dB to +31 dB with 90 MHz bandwidth

9 dB to 51 dB with 9 MHz bandwidth

**Any intermediate range, for example –1 dB to +41 dB  
with 30 MHz bandwidth**

**Bandwidth independent of variable gain**

**1.3 nV/ $\sqrt{\text{Hz}}$  input noise spectral density**

**$\pm 0.5$  dB typical gain accuracy**

### APPLICATIONS

**RF/IF AGC amplifier**

**Video gain control**

**A/D range extension**

**Signal measurement**

### GENERAL DESCRIPTION

The AD603 is a low noise, voltage-controlled amplifier for use in RF and IF AGC systems. It provides accurate, pin selectable gains of –11 dB to +31 dB with a bandwidth of 90 MHz or 9 dB to 51 dB with a bandwidth of 9 MHz. Any intermediate gain range may be arranged using one external resistor. The input referred noise spectral density is only 1.3 nV/ $\sqrt{\text{Hz}}$  and power consumption is 125 mW at the recommended  $\pm 5$  V supplies.

The decibel gain is linear in dB, accurately calibrated, and stable over temperature and supply. The gain is controlled at a high

impedance (50 M $\Omega$ ), low bias (200 nA) differential input; the scaling is 25 mV/dB, requiring a gain control voltage of only 1 V to span the central 40 dB of the gain range. An overrange and underrange of 1 dB is provided whatever the selected range. The gain control response time is less than 1  $\mu\text{s}$  for a 40 dB change.

The differential gain control interface allows the use of either differential or single-ended positive or negative control voltages. Several of these amplifiers may be cascaded and their gain control gains offset to optimize the system S/N ratio.

The AD603 can drive a load impedance as low as 100  $\Omega$  with low distortion. For a 500  $\Omega$  load in shunt with 5 pF, the total harmonic distortion for a  $\pm 1$  V sinusoidal output at 10 MHz is typically –60 dBc. The peak specified output is  $\pm 2.5$  V minimum into a 500  $\Omega$  load.

The AD603 uses a patented proprietary circuit topology—the X-AMP<sup>®</sup>. The X-AMP comprises a variable attenuator of 0 dB to –42.14 dB followed by a fixed-gain amplifier. Because of the attenuator, the amplifier never has to cope with large inputs and can use negative feedback to define its (fixed) gain and dynamic performance. The attenuator has an input resistance of 100  $\Omega$ , laser trimmed to  $\pm 3\%$ , and comprises a seven-stage R-2R ladder network, resulting in an attenuation between tap points of 6.021 dB. A proprietary interpolation technique provides a continuous gain control function which is linear in dB.

The AD603 is specified for operation from –40°C to +85°C.

### FUNCTIONAL BLOCK DIAGRAM

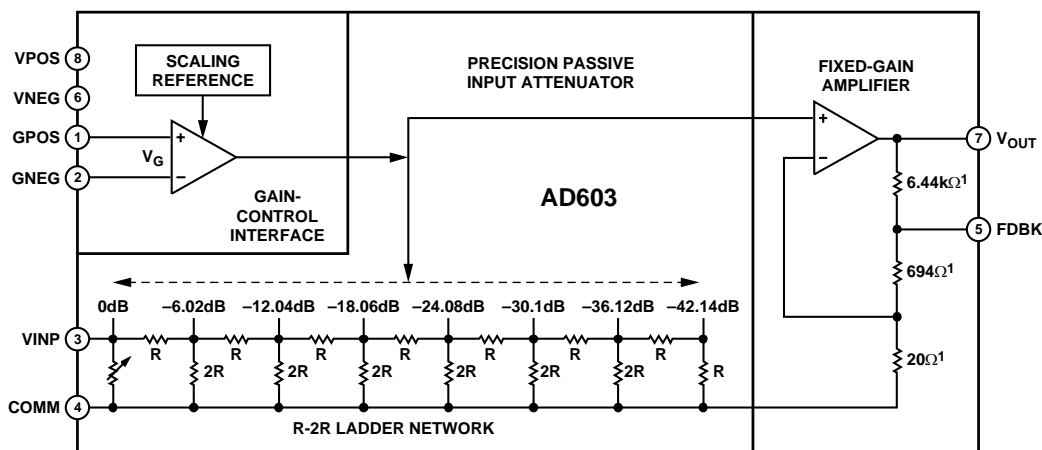

<sup>1</sup>NOMINAL VALUES.

Figure 1.

00039-001

### Rev. G

Information furnished by Analog Devices is believed to be accurate and reliable. However, no responsibility is assumed by Analog Devices for its use, nor for any infringements of patents or other rights of third parties that may result from its use. Specifications subject to change without notice. No license is granted by implication or otherwise under any patent or patent rights of Analog Devices. Trademarks and registered trademarks are the property of their respective owners.

**TABLE OF CONTENTS**

|  |    |   |    |
|--|----|---|----|
| Specifications.....                              | 3  | Using the AD603 in Cascade .....                      | 14 |
| Absolute Maximum Ratings.....                    | 4  | Sequential Mode (Optimal S/N Ratio).....              | 14 |
| ESD Caution.....                                 | 4  | Parallel Mode (Simplest Gain Control Interface) ..... | 16 |
| Pin Configuration and Function Descriptions..... | 5  | Low Gain Ripple Mode (Minimum Gain Error) .....       | 16 |
| Typical Performance Characteristics .....        | 6  | Applications.....                                     | 18 |
| Theory of Operation .....                        | 11 | A Low Noise AGC Amplifier .....                       | 18 |
| Noise Performance .....                          | 11 | Caution .....   | 19 |
| The Gain Control Interface.....                  | 12 | Outline Dimensions .....                              | 20 |
| Programming the Fixed-Gain Amplifier             |    | Ordering Guide .....                                  | 20 |
| Using Pin Strapping .....                        | 12 |   |    |

**REVISION HISTORY****3/05—Rev. F to Rev. G**

|  |           |
|--|-----------|
| Updated Format.....                                  | Universal |
| Change to Features .....                             | 1         |
| Changes to General Description .....                 | 1         |
| Change to Figure 1 .....                             | 1         |
| Changes to Specifications .....                      | 3         |
| New Figure 4 and Renumbering Subsequent Figures..... | 6         |
| Change to Figure 10 .....                            | 7         |
| Change to Figure 23 .....                            | 9         |
| Change to Figure 29 .....                            | 12        |
| Updated Outline Dimensions .....                     | 20        |

**4/04—Rev. E to Rev. F**

|                                 |   |
|---------------------------------|---|
| Changes to Specifications ..... | 2 |
| Changes to Ordering Guide ..... | 3 |

**8/03—Rev. D to Rev E**

|  |           |
|--|-----------|
| Updated Format.....  | Universal |
| Changes to Specifications .....                              | 2         |
| Changes to TPCs 2, 3, 4.....                                 | 4         |
| Changes to Sequential Mode (Optimal S/N Ratio) section ..... | 9         |
| Change to Figure 8 .....                                     | 10        |
| Updated Outline Dimensions .....                             | 14        |

## SPECIFICATIONS

@  $T_A = 25^\circ\text{C}$ ,  $V_S = \pm 5\text{ V}$ ,  $-500\text{ mV} \leq V_G \leq +500\text{ mV}$ ,  $G_{\text{NEG}} = 0\text{ V}$ ,  $-10\text{ dB}$  to  $+30\text{ dB}$  gain range,  $R_L = 500\ \Omega$ , and  $C_L = 5\text{ pF}$ , unless otherwise noted.

Table 1.

| Parameter   | Conditions   | Min        | Typ       | Max       | Unit                   |
|---|--|------------|-----------|-----------|------------------------|
| <b>INPUT CHARACTERISTICS</b>  |  |            |           |           |                        |
| Input Resistance  | Pin 3 to Pin 4   | 97         | 100       | 103       | $\Omega$               |
| Input Capacitance   |  |            | 2         |           | pF                     |
| Input Noise Spectral Density <sup>1</sup>                                   | Input short-circuited                                      |            | 1.3       |           | nV/ $\sqrt{\text{Hz}}$ |
| Noise Figure  | $f = 10\text{ MHz}$ , gain = max, $R_S = 10\ \Omega$       |            | 8.8       |           | dB                     |
| 1 dB Compression Point  | $f = 10\text{ MHz}$ , gain = max, $R_S = 10\ \Omega$       |            | -11       |           | dBm                    |
| Peak Input Voltage  |  |            | $\pm 1.4$ | $\pm 2$   | V                      |
| <b>OUTPUT CHARACTERISTICS</b>   |  |            |           |           |                        |
| -3 dB Bandwidth   | $V_{\text{OUT}} = 100\text{ mV rms}$                       |            | 90        |           | MHz                    |
| Slew Rate   | $R_L \geq 500\ \Omega$                                     |            | 275       |           | V/ $\mu\text{s}$       |
| Peak Output <sup>2</sup>  | $R_L \geq 500\ \Omega$                                     | $\pm 2.5$  | $\pm 3.0$ |           | V                      |
| Output Impedance  | $f \leq 10\text{ MHz}$                                     |            | 2         |           | $\Omega$               |
| Output Short-Circuit Current  |  |            | 50        |           | mA                     |
| Group Delay Change vs. Gain   | $f = 3\text{ MHz}$ ; full gain range                       |            | $\pm 2$   |           | ns                     |
| Group Delay Change vs. Frequency  | $V_G = 0\text{ V}$ ; $f = 1\text{ MHz}$ to $10\text{ MHz}$ |            | $\pm 2$   |           | ns                     |
| Differential Gain   |  |            | 0.2       |           | %                      |
| Differential Phase  |  |            | 0.2       |           | Degree                 |
| Total Harmonic Distortion   | $f = 10\text{ MHz}$ , $V_{\text{OUT}} = 1\text{ V rms}$    |            | -60       |           | dBc                    |
| Third Order Intercept   | $f = 40\text{ MHz}$ , gain = max, $R_S = 50\ \Omega$       |            | 15        |           | dBm                    |
| <b>ACCURACY</b>   |  |            |           |           |                        |
| Gain Accuracy, $f = 100\text{ kHz}$ ; Gain (dB) = $(40 V_G + 10)\text{ dB}$ | $-500\text{ mV} \leq V_G \leq +500\text{ mV}$ ,            | -1         | $\pm 0.5$ | +1        | dB                     |
| $T_{\text{MIN}}$ to $T_{\text{MAX}}$  |  | -1.5       |           | +1.5      | dB                     |
| Gain, $f = 10.7\text{ MHz}$   | $V_G = -0.5\text{ V}$                                      | -10.3      | -9.0      | -8.0      | dB                     |
|   | $V_G = 0.0\text{ V}$                                       | +9.5       | +10.5     | +11.5     | dB                     |
|   | $V_G = 0.5\text{ V}$                                       | +29.3      | +30.3     | +31.3     | dB                     |
| Output Offset Voltage <sup>3</sup>  | $V_G = 0\text{ V}$   | -20        |           | +20       | mV                     |
| $T_{\text{MIN}}$ to $T_{\text{MAX}}$  |  | -30        |           | +30       | mV                     |
| Output Offset Variation vs. $V_G$   | $-500\text{ mV} \leq V_G \leq +500\text{ mV}$              | -20        |           | +20       | mV                     |
| $T_{\text{MIN}}$ to $T_{\text{MAX}}$  |  | -30        |           | +30       | mV                     |
| <b>GAIN CONTROL INTERFACE</b>   |  |            |           |           |                        |
| Gain Scaling Factor   | 100 kHz  | 39.4       | 40        | 40.6      | dB/V                   |
| $T_{\text{MIN}}$ to $T_{\text{MAX}}$  |  | 38         |           | 42        | dB/V                   |
|   | 10.7 MHz   | 38.7       | 39.3      | 39.9      | dB/V                   |
| GNEG, GPOS Voltage Range <sup>4</sup>                                       |  | -1.2       |           | +2.0      | V                      |
| Input Bias Current  |  |            | 200       |           | nA                     |
| Input Offset Current  |  |            | 10        |           | nA                     |
| Differential Input Resistance   | Pin 1 to Pin 2   |            | 50        |           | M $\Omega$             |
| Response Rate   | Full 40 dB gain change                                     |            | 80        |           | dB/ $\mu\text{s}$      |
| <b>POWER SUPPLY</b>   |  |            |           |           |                        |
| Specified Operating Range   |  | $\pm 4.75$ |           | $\pm 6.3$ | V                      |
| Quiescent Current   |  |            | 12.5      | 17        | mA                     |
| $T_{\text{MIN}}$ to $T_{\text{MAX}}$  |  |            |           | 20        | mA                     |

<sup>1</sup> Typical open or short-circuited input; noise is lower when system is set to maximum gain and input is short-circuited. This figure includes the effects of both voltage and current noise sources.

<sup>2</sup> Using resistive loads of  $500\ \Omega$  or greater, or with the addition of a  $1\text{ k}\Omega$  pull-down resistor when driving lower loads.

<sup>3</sup> The dc gain of the main amplifier in the AD603 is  $\times 35.7$ ; thus, an input offset of  $100\ \mu\text{V}$  becomes a  $3.57\text{ mV}$  output offset.

<sup>4</sup> GNEG and GPOS, gain control, and voltage range are guaranteed to be within the range of  $-V_S + 4.2\text{ V}$  to  $+V_S - 3.4\text{ V}$  over the full temperature range of  $-40^\circ\text{C}$  to  $+85^\circ\text{C}$ .

# AD603

## ABSOLUTE MAXIMUM RATINGS

Table 2.

| Parameter                                 | Rating                                      |
|---|---|
| Supply Voltage $\pm V_S$                  | $\pm 7.5$ V                                 |
| Internal Voltage VINP (Pin 3)             | $\pm 2$ V Continuous<br>$\pm V_S$ for 10 ms |
| GPOS, GNEG (Pins 1, 2)                    | $\pm V_S$                                   |
| Internal Power Dissipation <sup>1</sup>   | 400 mW                                      |
| Operating Temperature Range               |   |
| AD603A                                    | -40°C to +85°C                              |
| AD603S                                    | -55°C to +125°C                             |
| Storage Temperature Range                 | -65°C to +150°C                             |
| Lead Temperature Range (Soldering 60 sec) | 300°C                                       |

<sup>1</sup> Thermal Characteristics:

8-Lead SOIC Package:  $\theta_{JA} = 155^\circ\text{C/W}$ ,  $\theta_{JC} = 33^\circ\text{C/W}$ ,

8-Lead CERDIP Package:  $\theta_{JA} = 140^\circ\text{C/W}$ ,  $\theta_{JC} = 15^\circ\text{C/W}$ .

Stresses above those listed under Absolute Maximum Ratings may cause permanent damage to the device. This is a stress rating only; functional operation of the device at these or any other conditions above those indicated in the operational section of this specification is not implied. Exposure to absolute maximum rating conditions for extended periods may affect device reliability.

## ESD CAUTION

ESD (electrostatic discharge) sensitive device. Electrostatic charges as high as 4000 V readily accumulate on the human body and test equipment and can discharge without detection. Although this product features proprietary ESD protection circuitry, permanent damage may occur on devices subjected to high energy electrostatic discharges. Therefore, proper ESD precautions are recommended to avoid performance degradation or loss of functionality.



## PIN CONFIGURATION AND FUNCTION DESCRIPTIONS

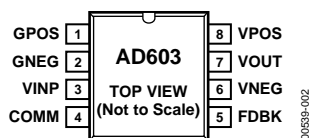

Figure 2. 8-Lead Plastic SOIC (R) Package

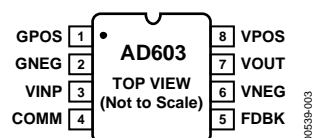

Figure 3. 8-Lead Ceramic CERDIP (Q) Package

Table 3. Pin Function Descriptions

| Pin No. | Mnemonic | Description  |
|---------|----------|--|
| 1       | GPOS     | Gain Control Input High (Positive Voltage Increases Gain). |
| 2       | GNEG     | Gain Control Input Low (Negative Voltage Increases Gain).  |
| 3       | VINP     | Amplifier Input.   |
| 4       | COMM     | Amplifier Ground.  |
| 5       | FDBK     | Connection to Feedback Network.                            |
| 6       | VNEG     | Negative Supply Input.                                     |
| 7       | VOUT     | Amplifier Output.  |
| 8       | VPOS     | Positive Supply Input.                                     |

## TYPICAL PERFORMANCE CHARACTERISTICS

@  $T_A = 25^\circ\text{C}$ ,  $V_S = \pm 5\text{ V}$ ,  $-500\text{ mV} \leq V_G \leq +500\text{ mV}$ ,  $G_{NEG} = 0\text{ V}$ ,  $-10\text{ dB}$  to  $+30\text{ dB}$  gain range,  $R_L = 500\ \Omega$ , and  $C_L = 5\text{ pF}$ , unless otherwise noted.

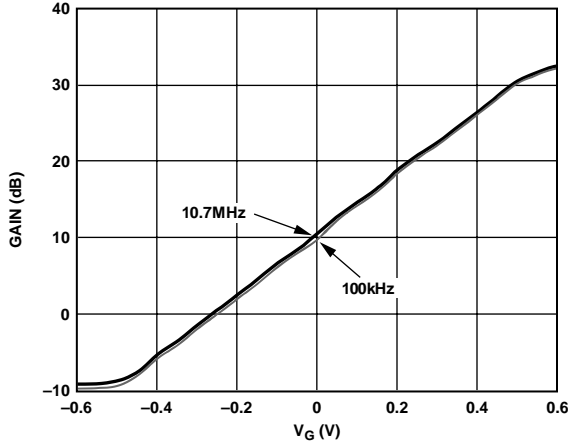

Figure 4. Gain vs.  $V_G$  at 100 kHz and 10.7 MHz

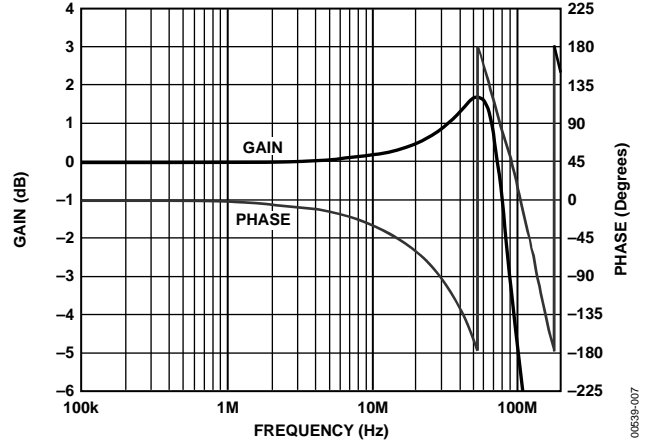

Figure 7. Frequency and Phase Response vs. Gain (Gain =  $+10\text{ dB}$ ,  $P_{IN} = -30\text{ dBm}$ )

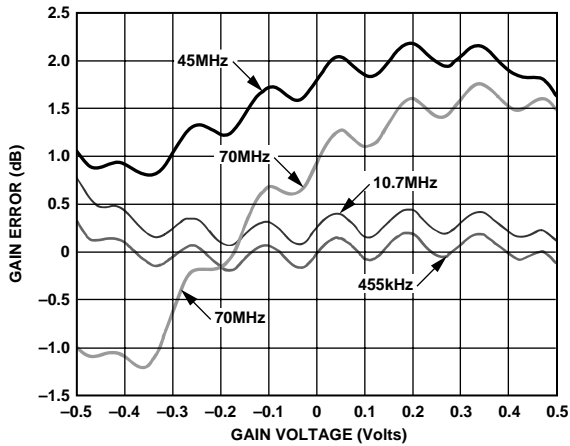

Figure 5. Gain Error vs. Gain Control Voltage at 455 kHz, 10.7 MHz, 45 MHz, 70 MHz

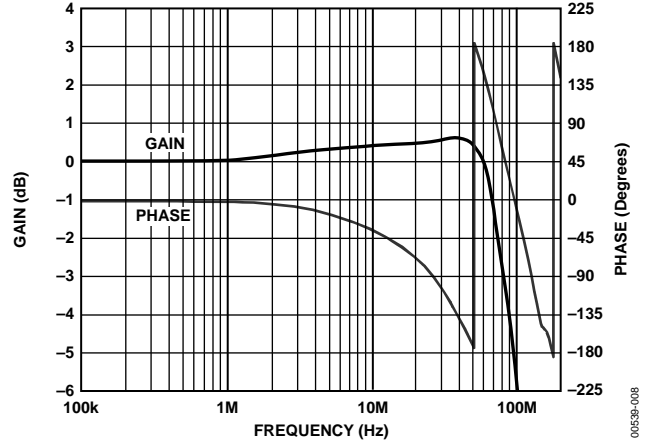

Figure 8. Frequency and Phase Response vs. Gain (Gain =  $+30\text{ dB}$ ,  $P_{IN} = -30\text{ dBm}$ )

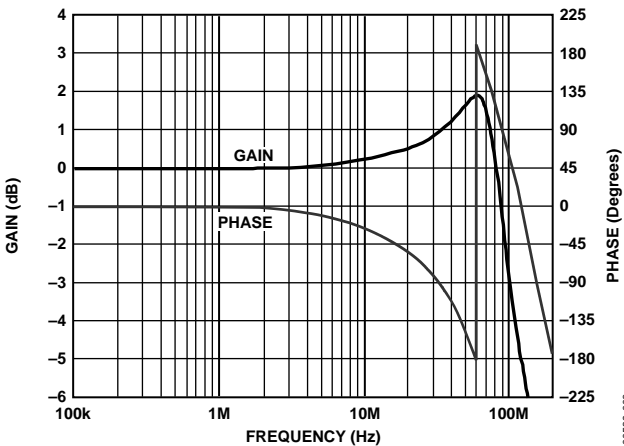

Figure 6. Frequency and Phase Response vs. Gain (Gain =  $-10\text{ dB}$ ,  $P_{IN} = -30\text{ dBm}$ )

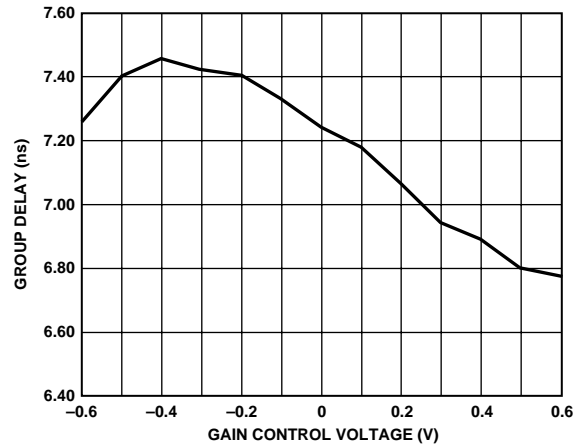

Figure 9. Group Delay vs. Gain Control Voltage

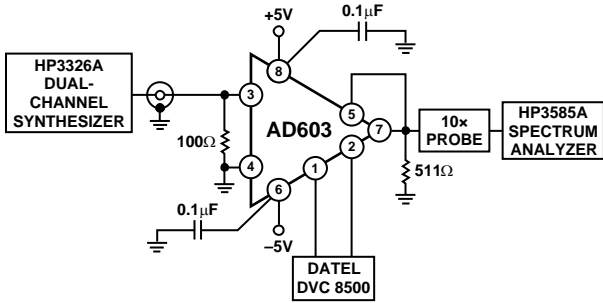

Figure 10. Third Order Intermodulation Distortion Test Setup

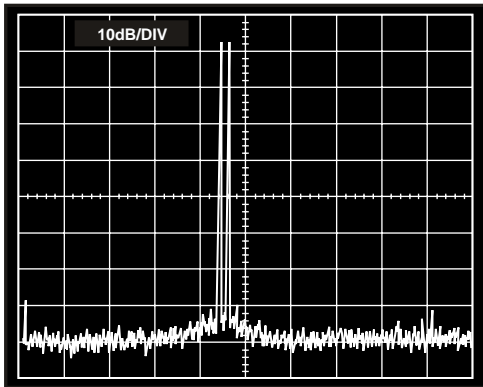

Figure 11. Third Order Intermodulation Distortion at 455 kHz (10x Probe Used to HP3585A Spectrum Analyzer, Gain = 0 dB,  $P_{IN} = 0$  dBm)

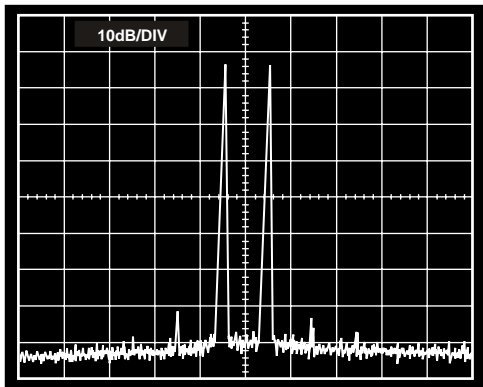

Figure 12. Third Order Intermodulation Distortion at 10.7 MHz (10x Probe Used to HP3585A Spectrum Analyzer, Gain = 0 dB,  $P_{IN} = 0$  dBm)

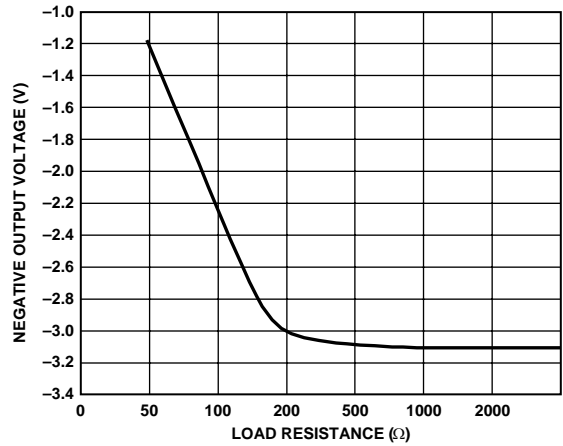

Figure 13. Typical Output Voltage Swing vs. Load Resistance (Negative Output Swing Limits First)

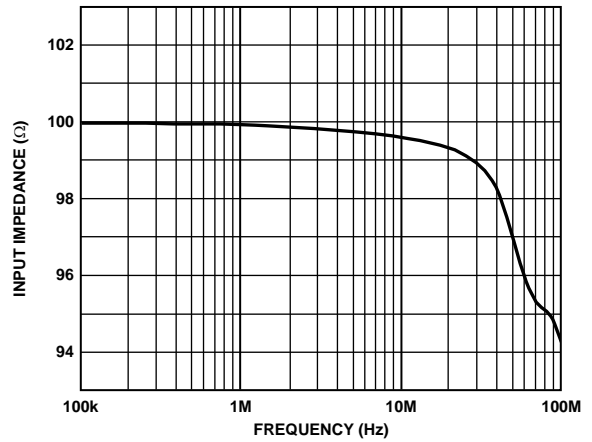

Figure 14. Input Impedance vs. Frequency (Gain = -10 dB)

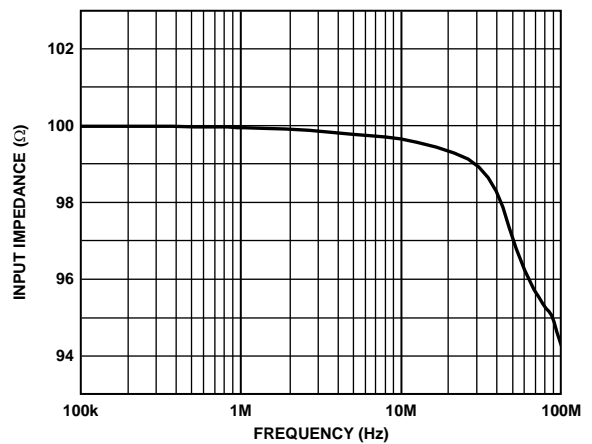

Figure 15. Input Impedance vs. Frequency (Gain = +10 dB)

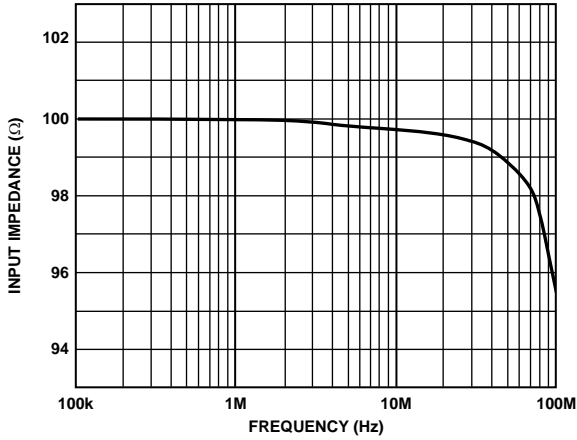

Figure 16. Input Impedance vs. Frequency (Gain = +30 dB)

00539-016

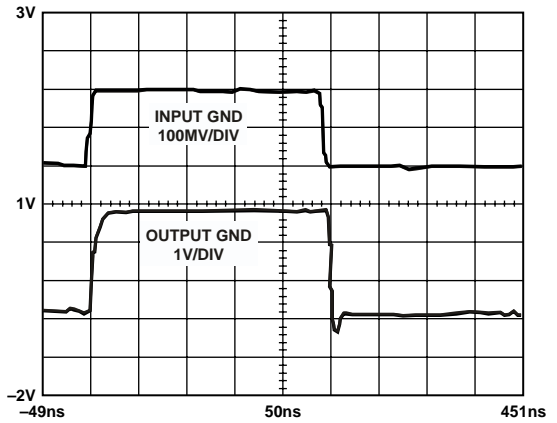

Figure 19. Output Stage Overload Recovery Time (Input Is 500 ns Period, 50% Duty Cycle Square Wave, Output is Captured Using Tektronix 11402 Digitizing Oscilloscope)

00539-019

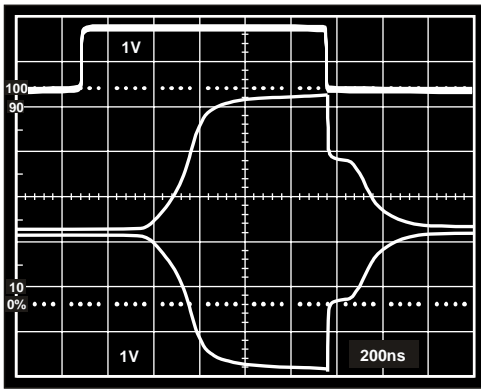

Figure 17. Gain Control Channel Response Time

00539-017

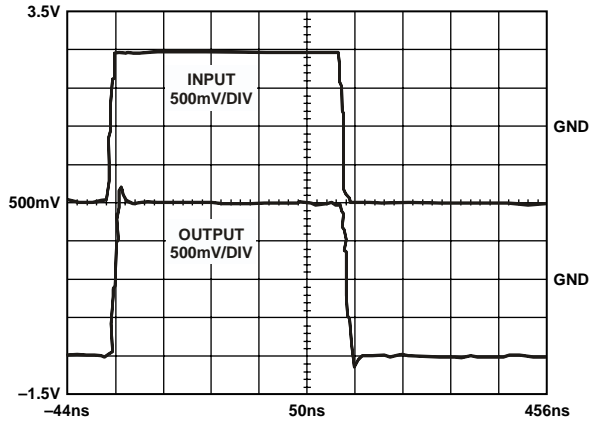

Figure 20. Transient Response,  $G = 0$  dB (Input is 500 ns Period, 50% Duty Cycle Square Wave, Output is Captured Using Tektronix 11402 Digitizing Oscilloscope)

00539-020

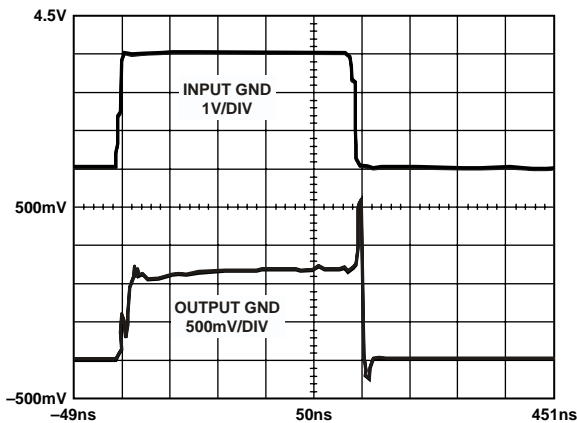

Figure 18. Input Stage Overload Recovery Time (Input is 500 ns Period, 50% Duty Cycle Square Wave, Output is Captured Using Tektronix 11402 Digitizing Oscilloscope)

00539-018

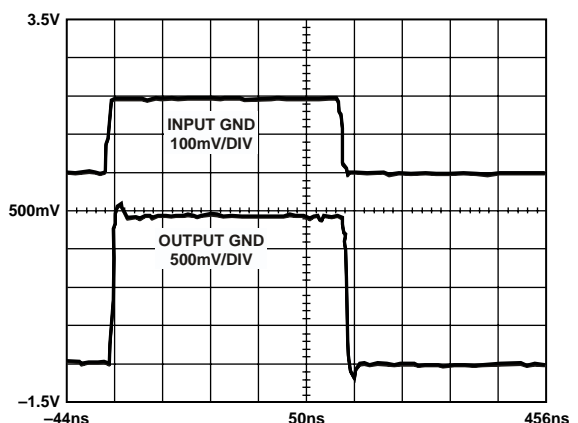

Figure 21. Transient Response,  $G = +20$  dB (Input is 500 ns Period, 50% Duty Cycle Square Wave, Output is Captured Using Tektronix 11402 Digitizing Oscilloscope)

00539-021



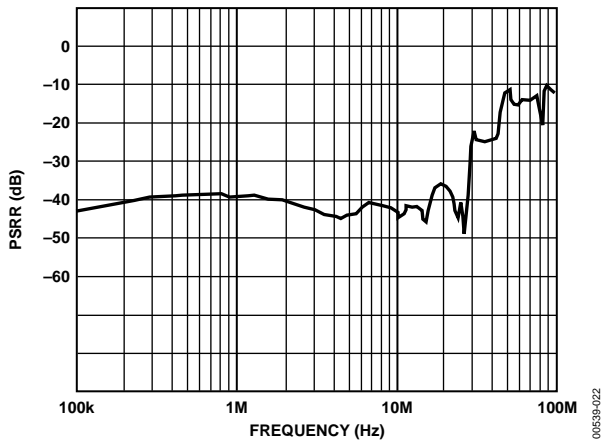

Figure 22. PSRR vs. Frequency  
(Worst Case is Negative Supply PSRR, Shown Here)

00539-022

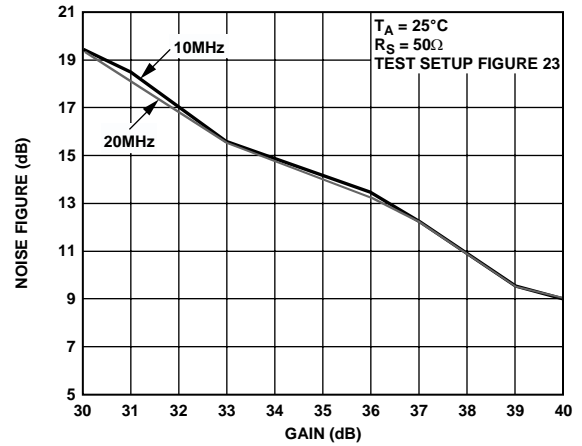

Figure 25. Noise Figure in 0 dB/40 dB Mode

00539-025

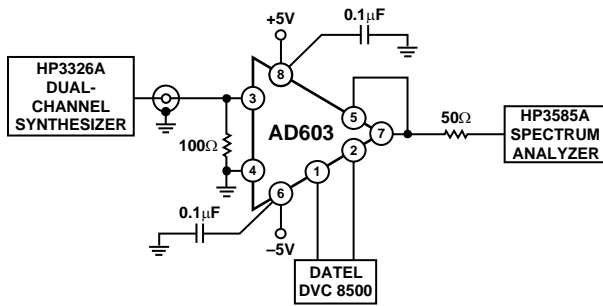

Figure 23. Test Setup Used for: Noise Figure, Third Order Intercept and 1 dB Compression Point Measurements

00539-023

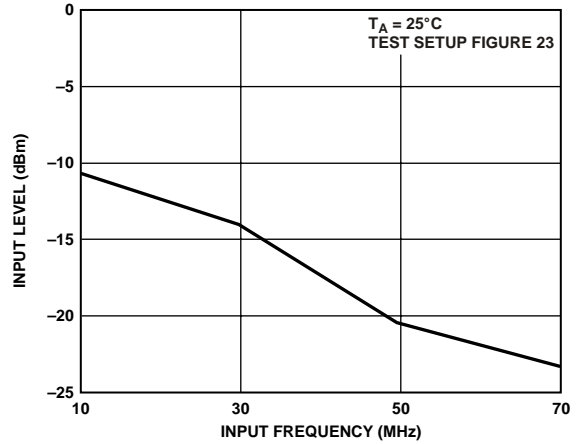

Figure 26. 1 dB Compression Point, -10 dB/+30 dB Mode, Gain = +30 dB

00539-026

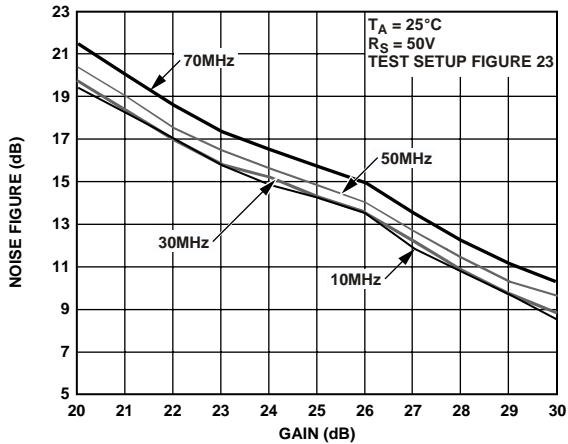

Figure 24. Noise Figure in -10 dB/+30 dB Mode

00539-024

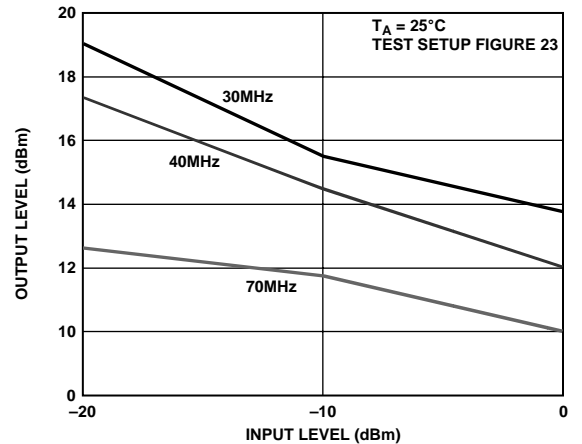

Figure 27. Third Order Intercept -10 dB/+30 dB Mode, Gain = +10 dB

00539-027

# AD603

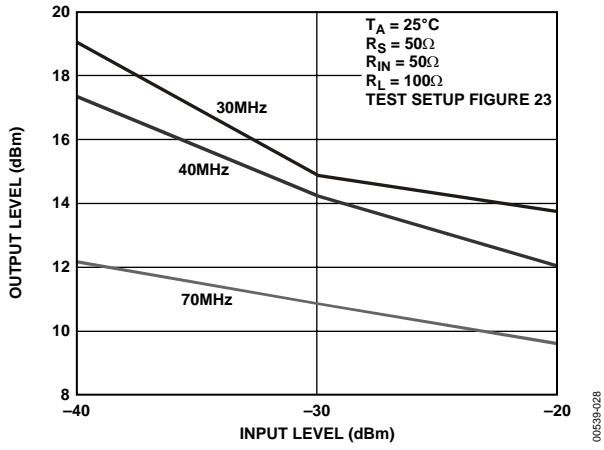

Figure 28. Third Order Intercept -10 dB/+30 dB Mode, Gain = +30 dB

## THEORY OF OPERATION

The AD603 comprises a fixed-gain amplifier, preceded by a broadband passive attenuator of 0 dB to 42.14 dB, having a gain control scaling factor of 40 dB per volt. The fixed gain is laser-trimmed in two ranges, to either 31.07 dB ( $\times 35.8$ ) or 50 dB ( $\times 358$ ), or may be set to any range in between using one external resistor between Pin 5 and Pin 7. Somewhat higher gain can be obtained by connecting the resistor from Pin 5 to common, but the increase in output offset voltage limits the maximum gain to about 60 dB. For any given range, the bandwidth is independent of the voltage-controlled gain. This system provides an underrange and overrange of 1.07 dB in all cases; for example, the overall gain is  $-11.07$  dB to  $+31.07$  dB in the maximum bandwidth mode (Pin 5 and Pin 7 strapped).

This X-AMP structure has many advantages over former methods of gain control based on nonlinear elements. Most importantly, the fixed-gain amplifier can use negative feedback to increase its accuracy. Since large inputs are first attenuated, the amplifier input is always small. For example, to deliver a  $\pm 1$  V output in the  $-1$  dB/ $+41$  dB mode (that is, using a fixed amplifier gain of 41.07 dB) its input is only 8.84 mV; thus the distortion can be very low. Equally important, the small-signal gain and phase response, and thus the pulse response, are essentially independent of gain.

Figure 29 is a simplified schematic. The input attenuator is a seven-section R-2R ladder network, using untrimmed resistors of nominally  $R = 62.5 \Omega$ , which results in a characteristic resistance of  $125 \Omega \pm 20\%$ . A shunt resistor is included at the input and laser trimmed to establish a more exact input resistance of  $100 \Omega \pm 3\%$ , which ensures accurate operation (gain and HP corner frequency) when used in conjunction with external resistors or capacitors.

The nominal maximum signal at input VINP is 1 V rms ( $\pm 1.4$  V peak) when using the recommended  $\pm 5$  V supplies, although operation to  $\pm 2$  V peak is permissible with some increase in HF distortion and feedthrough. Pin 4 (COMM) must be connected directly to the input ground; significant impedance in this connection will reduce the gain accuracy.

The signal applied at the input of the ladder network is attenuated by 6.02 dB by each section; thus, the attenuation to each of the taps is progressively 0 dB, 6.02 dB, 12.04 dB, 18.06 dB, 24.08 dB, 30.1 dB, 36.12 dB, and 42.14 dB. A unique circuit technique is employed to interpolate between these tap points, indicated by the slider in Figure 29, thus providing

continuous attenuation from 0 dB to 42.14 dB. It will help in understanding the AD603 to think in terms of a mechanical means for moving this slider from left to right; in fact, its position is controlled by the voltage between Pin 1 and Pin 2. The details of the gain control interface are discussed later.

The gain is at all times very exactly determined, and a linear-in-dB relationship is automatically guaranteed by the exponential nature of the attenuation in the ladder network (the X-AMP principle). In practice, the gain deviates slightly from the ideal law, by about  $\pm 0.2$  dB peak (see, for example, Figure 5).

## NOISE PERFORMANCE

An important advantage of the X-AMP is its superior noise performance. The nominal resistance seen at inner tap points is  $41.7 \Omega$  (one third of  $125 \Omega$ ), which exhibits a Johnson noise spectral density (NSD) of  $0.83 \text{ nV}/\sqrt{\text{Hz}}$  (that is,  $\sqrt{4kTR}$ ) at  $27^\circ\text{C}$ , which is a large fraction of the total input noise. The first stage of the amplifier contributes a further  $1 \text{ nV}/\sqrt{\text{Hz}}$ , for a total input noise of  $1.3 \text{ nV}/\sqrt{\text{Hz}}$ . It will be apparent that it is essential to use a low resistance in the ladder network to achieve the very low specified noise level. The signal's source impedance forms a voltage divider with the AD603's  $100 \Omega$  input resistance. In some applications, the resulting attenuation may be unacceptable, requiring the use of an external buffer or preamplifier to match a high impedance source to the low impedance AD603.

The noise at maximum gain (that is, at the 0 dB tap) depends on whether the input is short-circuited or open-circuited: when shorted, the minimum NSD of slightly over  $1 \text{ nV}/\sqrt{\text{Hz}}$  is achieved; when open, the resistance of  $100 \Omega$  looking into the first tap generates  $1.29 \text{ nV}/\sqrt{\text{Hz}}$ , so the noise increases to a total of  $1.63 \text{ nV}/\sqrt{\text{Hz}}$ . (This last calculation would be important if the AD603 were preceded by, for example, a  $900 \Omega$  resistor to allow operation from inputs up to 10 V rms.) As the selected tap moves away from the input, the dependence of the noise on source impedance quickly diminishes.

Apart from the small variations just discussed, the signal-to-noise (S/N) ratio at the output is essentially independent of the attenuator setting. For example, on the  $-11$  dB/ $+31$  dB range, the fixed gain of  $\times 35.8$  raises the output NSD to  $46.5 \text{ nV}/\sqrt{\text{Hz}}$ . Thus, for the maximum undistorted output of 1 V rms and a 1 MHz bandwidth, the output S/N ratio would be 86.6 dB, that is,  $20 \log (1 \text{ V}/46.5 \mu\text{V})$ .

# AD603

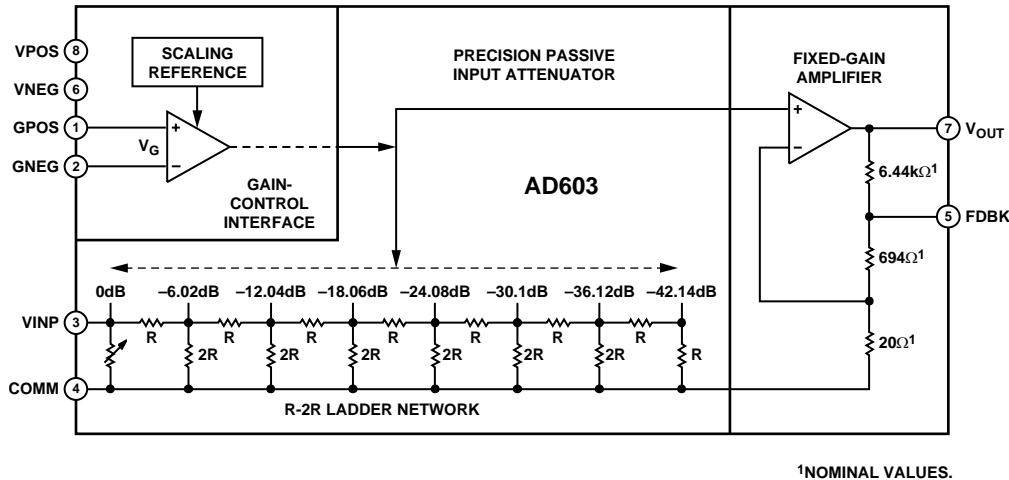

Figure 29. Simplified Block Diagram

## THE GAIN CONTROL INTERFACE

The attenuation is controlled through a differential, high impedance (50 MΩ) input, with a scaling factor which is laser-trimmed to 40 dB per volt, that is, 25 mV/dB. An internal band gap reference ensures stability of the scaling with respect to supply and temperature variations.

When the differential input voltage  $V_G = 0$  V, the attenuator slider is centered, providing an attenuation of 21.07 dB. For the maximum bandwidth range, this results in an overall gain of 10 dB (= -21.07 dB + 31.07 dB). When the control input is -500 mV, the gain is lowered by 20 dB (= 0.500 V × 40 dB/V) to -10 dB; when set to +500 mV, the gain is increased by 20 dB to 30 dB. When this interface is overdriven in either direction, the gain approaches either -11.07 dB (= -42.14 dB + 31.07 dB) or 31.07 dB (= 0 + 31.07 dB), respectively. The only constraint on the gain control voltage is that it be kept within the common-mode range (-1.2 V to +2.0 V assuming +5 V supplies) of the gain control interface.

The basic gain of the AD603 can thus be calculated using the following simple expression:

$$\text{Gain (dB)} = 40 V_G + 10 \quad (1)$$

where  $V_G$  is in volts. When Pin 5 and Pin 7 are strapped (see next section), the gain becomes

$$\text{Gain (dB)} = 40 V_G + 20 \text{ for } 0 \text{ to } +40 \text{ dB}$$

and

$$\text{Gain (dB)} = 40 V_G + 30 \text{ for } +10 \text{ to } +50 \text{ dB} \quad (2)$$

The high impedance gain control input ensures minimal loading when driving many amplifiers in multiple channel or cascaded applications. The differential capability provides flexibility in choosing the appropriate signal levels and polarities for various control schemes.

For example, if the gain is to be controlled by a DAC providing a positive only ground-referenced output, the Gain Control Low (GNEG) pin should be biased to a fixed offset of 500 mV to set the gain to -10 dB when Gain Control High (GPOS) is at zero, and to 30 dB when at 1.00 V.

It is a simple matter to include a voltage divider to achieve other scaling factors. When using an 8-bit DAC having an FS output of 2.55 V (10 mV/bit), a divider ratio of 2 (generating 5 mV/bit) would result in a gain-setting resolution of 0.2 dB/bit. The use of such offsets is valuable when two AD603s are cascaded, when various options exist for optimizing the S/N profile, as will be shown later.

## PROGRAMMING THE FIXED-GAIN AMPLIFIER USING PIN STRAPPING

Access to the feedback network is provided at Pin 5 (FDBK). The user may program the gain of the AD603's output amplifier using this pin, as shown in Figure 30, Figure 31, and Figure 32. There are three modes: in the default mode, FDBK is unconnected, providing the range +9 dB/+51 dB; when  $V_{OUT}$  and FDBK are shorted, the gain is lowered to -11 dB/+31 dB; and when an external resistor is placed between  $V_{OUT}$  and FDBK any intermediate gain can be achieved, for example, -1 dB/+41 dB. Figure 33 shows the nominal maximum gain vs. external resistor for this mode.

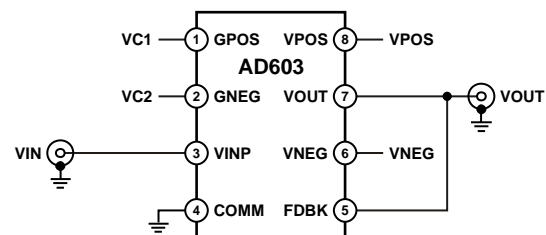

Figure 30. -10 dB to +30 dB; 90 MHz Bandwidth

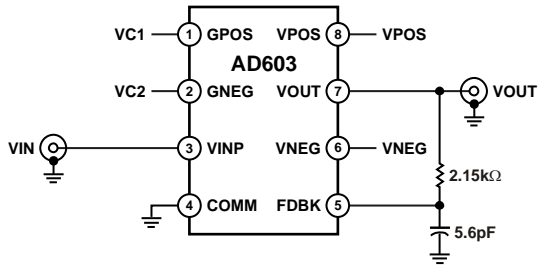

Figure 31. 0 dB to 40 dB; 30 MHz Bandwidth

00539-031

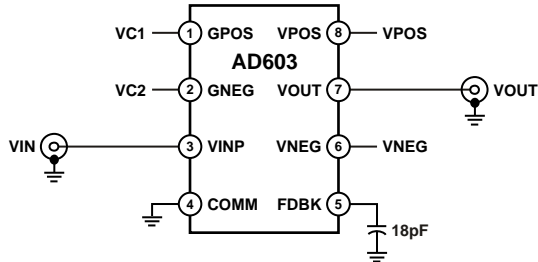

Figure 32. 10 dB to 50 db; 9 MHz to Set Gain

00539-032

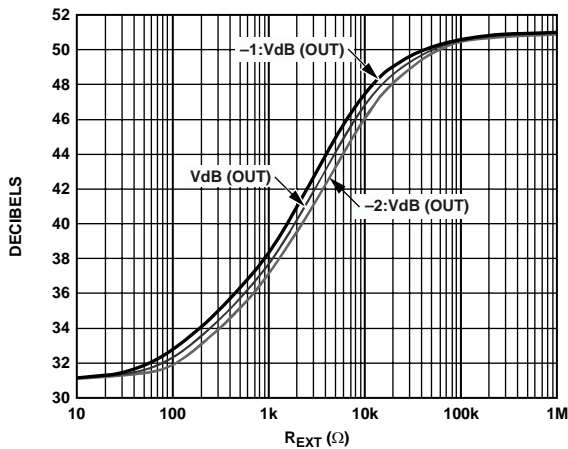

Figure 33. Gain vs.  $R_{EXT}$ , Showing Worst-Case Limits Assuming Internal Resistors have a Maximum Tolerance of 20%

00539-033

Optionally, when a resistor is placed from FDBK to COMM, higher gains can be achieved. This fourth mode is of limited value because of the low bandwidth and the elevated output offsets; it is thus not included in Figure 30, Figure 31, or Figure 32.

The gain of this amplifier in the first two modes is set by the ratio of on-chip laser-trimmed resistors. While the ratio of these resistors is very accurate, the absolute value of these resistors can vary by as much as  $\pm 20\%$ . Thus, when an external resistor is connected in parallel with the nominal  $6.44\text{ k}\Omega \pm 20\%$  internal resistor, the overall gain accuracy is somewhat poorer. The worst-case error occurs at about  $2\text{ k}\Omega$  (see Figure 34).

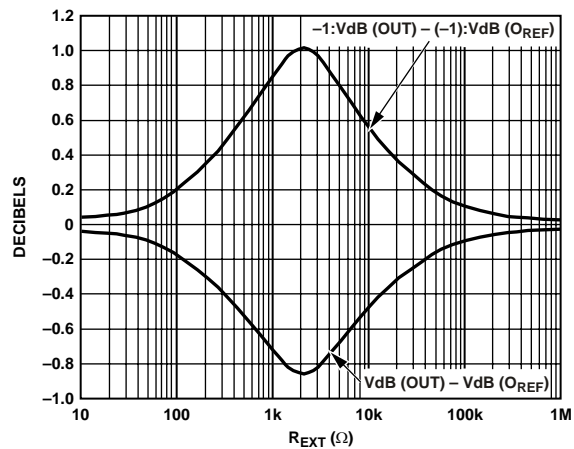

Figure 34. Worst-Case Gain Error, Assuming Internal Resistors have a Maximum Tolerance of  $-20\%$  (Top Curve) or  $+20\%$  (Bottom Curve)

00539-034

While the gain bandwidth product of the fixed-gain amplifier is about 4 GHz, the actual bandwidth is not exactly related to the maximum gain. This is because there is a slight enhancing of the ac response magnitude on the maximum bandwidth range, due to higher order poles in the open-loop gain function; this mild peaking is not present on the higher gain ranges. Figure 30, Figure 31, and Figure 32 show how an optional capacitor may be added to extend the frequency response in high gain modes.

## USING THE AD603 IN CASCADE

Two or more AD603s can be connected in series to achieve higher gain. Invariably, ac coupling must be used to prevent the dc offset voltage at the output of each amplifier from overloading the following amplifier at maximum gain. The required high-pass coupling network will usually be just a capacitor, chosen to set the desired corner frequency in conjunction with the well-defined 100 Ω input resistance of the following amplifier.

For two AD603s, the total gain control range becomes 84 dB (2 × 42.14 dB); the overall -3 dB bandwidth of cascaded stages will be somewhat reduced. Depending on the pin strapping, the gain and bandwidth for two cascaded amplifiers can range from -22 dB to +62 dB (with a bandwidth of about 70 MHz) to +22 dB to +102 dB (with a bandwidth of about 6 MHz).

There are several ways of connecting the gain control inputs in cascaded operation. The choice depends on whether it is important to achieve the highest possible instantaneous signal-to-noise ratio (ISNR), or, alternatively, to minimize the ripple in the gain error. The following examples feature the AD603 programmed for maximum bandwidth; the explanations apply to other gain/bandwidth combinations with appropriate changes to the arrangements for setting the maximum gain.

### SEQUENTIAL MODE (OPTIMAL S/N RATIO)

In the sequential mode of operation, the ISNR is maintained at its highest level for as much of the gain control range as possible. Figure 35 shows the SNR over a gain range of -22 dB to +62 dB, assuming an output of 1 V rms and a 1 MHz bandwidth; Figure 36, Figure 37, and Figure 38 show the general connections to accomplish this. Here, both the positive gain control inputs (GPOS) are driven in parallel by a positive-only, ground-referenced source with a range of 0 V to +2 V, while the negative gain control inputs (GNEG) are biased by stable voltages to provide the needed gain offsets. These voltages may

be provided by resistive dividers operating from a common voltage reference.

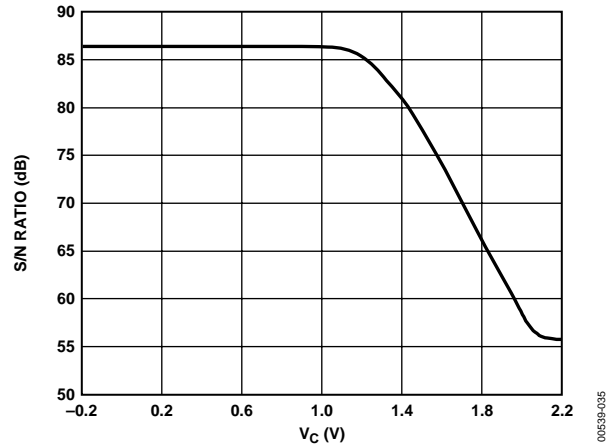

Figure 35. SNR vs. Control Voltage–Sequential Control (1 MHz Bandwidth)

The gains are offset (Figure 39) such that A2’s gain is increased only after A1’s gain has reached its maximum value. Note that for a differential input of -600 mV or less, the gain of a single amplifier (A1 or A2) will be at its minimum value of -11.07 dB; for a differential input of +600 mV or more, the gain will be at its maximum value of 31.07 dB. Control inputs beyond these limits will not affect the gain and can be tolerated without damage or foldover in the response. This is an important aspect of the AD603’s gain control response. (See the Specifications section for more details on the allowable voltage range.) The gain is now

$$\text{Gain (dB)} = 40 V_G + G_O \tag{3}$$

where  $V_G$  is the applied control voltage and  $G_O$  is determined by the gain range chosen. In the explanatory notes that follow, it is assumed the maximum bandwidth connections are used, for which  $G_O$  is -20 dB.

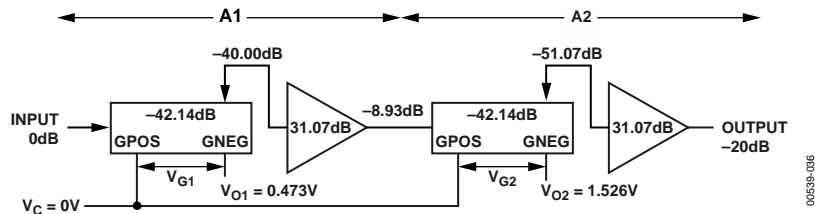

Figure 36. AD603 Gain Control Input Calculations for Sequential Control Operation  $V_C = 0 V$

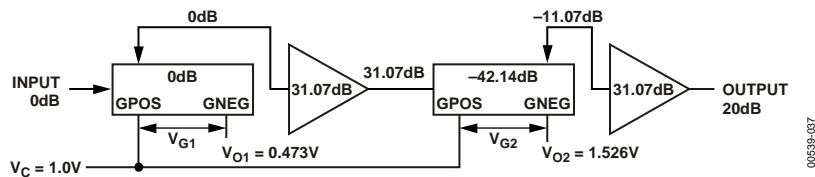

Figure 37. AD603 Gain Control Calculations for Sequential Control Operation  $V_C = 1.0 V$

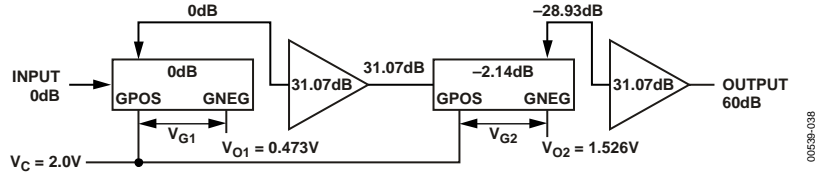

Figure 38. AD603 Gain Control Input Calculations for Sequential Operation  $V_C = 2.0V$

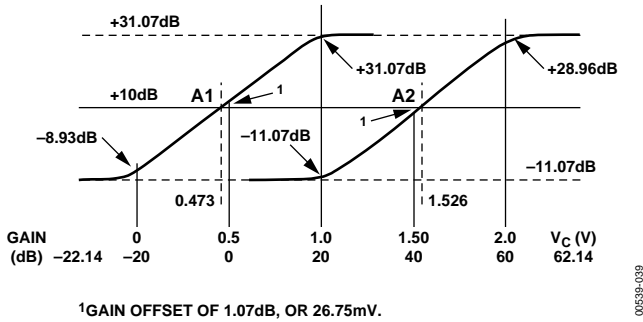

Figure 39. Explanation of Offset Calibration for Sequential Control

With reference to Figure 36, Figure 37, and Figure 38, note that  $V_{G1}$  refers to the differential gain control input to A1, and  $V_{G2}$  refers to the differential gain control input to A2. When  $V_G$  is 0,  $V_{G1} = -473$  mV and thus the gain of A1 is  $-8.93$  dB (recall that the gain of each individual amplifier in the maximum bandwidth mode is  $-10$  dB for  $V_G = -500$  mV and  $10$  dB for  $V_G = 0$  V); meanwhile,  $V_{G2} = -1.908$  V so the gain of A2 is pinned at  $-11.07$  dB. The overall gain is thus  $-20$  dB. See Figure 36.

When  $V_G = +1.00$  V,  $V_{G1} = 1.00$  V  $- 0.473$  V =  $+0.526$  V, which sets the gain of A1 to at nearly its maximum value of  $31.07$  dB, while  $V_{G2} = 1.00$  V  $- 1.526$  V =  $0.526$  V, which sets A2's gain at nearly its minimum value of  $-11.07$  dB. Close analysis shows that the degree to which neither AD603 is completely pushed to its maximum nor minimum gain exactly cancels in the overall gain, which is now  $+20$  dB. See Figure 37.

When  $V_G = 2.0$  V, the gain of A1 is pinned at  $31.07$  dB and that of A2 is near its maximum value of  $28.93$  dB, resulting in an overall gain of  $60$  dB (see Figure 38). This mode of operation is further clarified by Figure 40, which is a plot of the separate gains of A1 and A2 and the overall gain vs. the control voltage. Figure 41 is a plot of the SNR of the cascaded amplifiers vs. the control voltage. Figure 42 is a plot of the gain error of the cascaded stages vs. the control voltages.

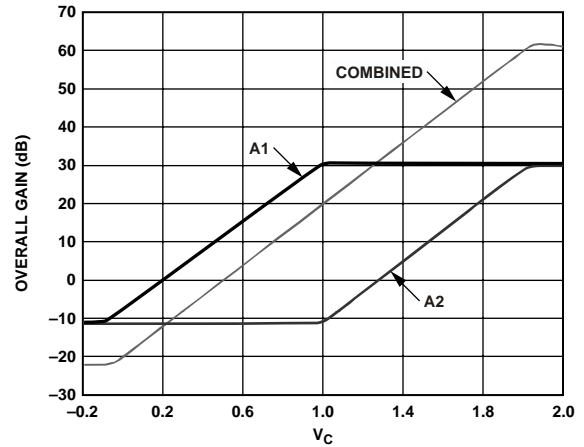

Figure 40. Plot of Separate and Overall Gains in Sequential Control

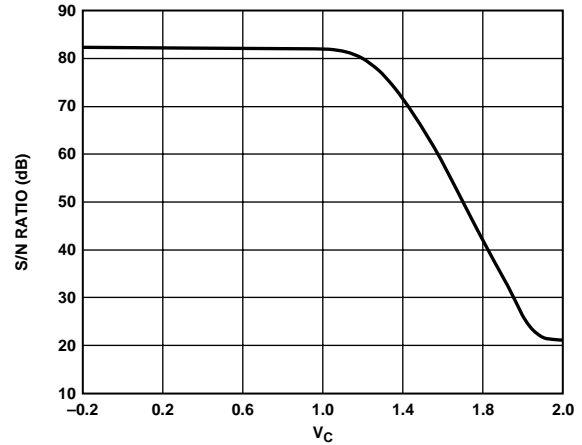

Figure 41. SNR for Cascaded Stages—Sequential Control

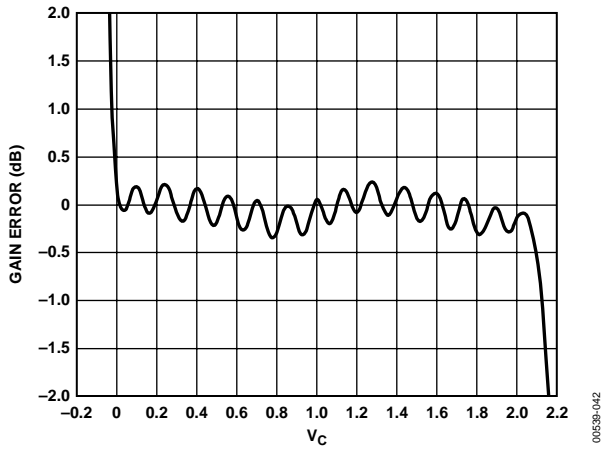

Figure 42. Gain Error for Cascaded Stages—Sequential Control

## PARALLEL MODE (SIMPLEST GAIN CONTROL INTERFACE)

In this mode, the gain control of voltage is applied to both inputs in parallel—the GPOS pins of both A1 and A2 are connected to the control voltage and the GNEW inputs are grounded. The gain scaling is then doubled to 80 dB/V, requiring only a 1.00 V change for an 80 dB change of gain:

$$\text{Gain} = (\text{dB}) = 80 V_G + G_0 \quad (4)$$

where, as before,  $G_0$  depends on the range selected; for example, in the maximum bandwidth mode,  $G_0$  is +20 dB. Alternatively, the GNEG pins may be connected to an offset voltage of 0.500 V, in which case  $G_0$  is -20 dB.

The amplitude of the gain ripple in this case is also doubled, as shown in Figure 43, while the instantaneous signal-to-noise ratio at the output of A2 now decreases linearly as the gain increases, as shown in Figure 44.

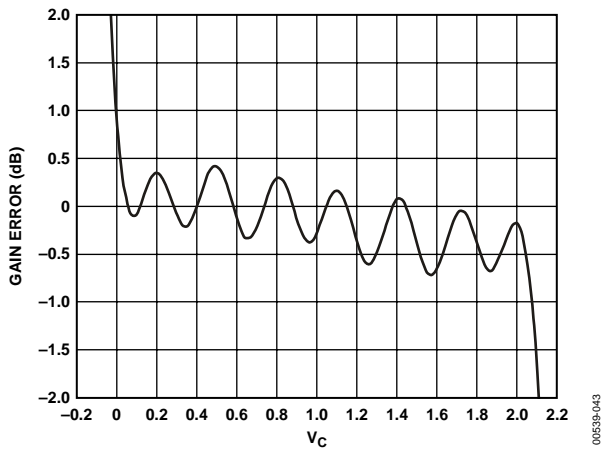

Figure 43. Gain Error for Cascaded Stages—Parallel Control

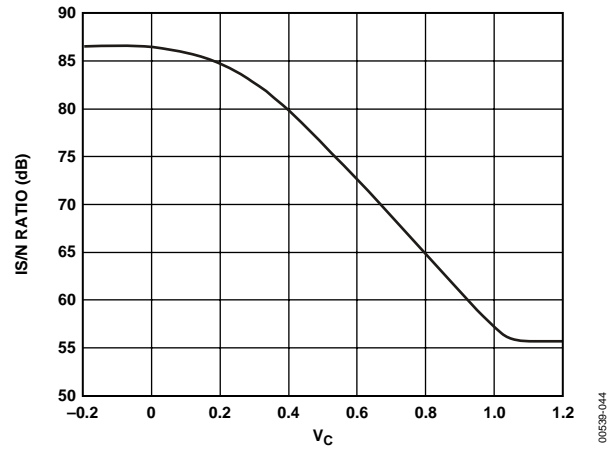

Figure 44. ISNR for Cascaded Stages—Parallel Control

## LOW GAIN RIPPLE MODE (MINIMUM GAIN ERROR)

As can be seen in Figure 42 and Figure 43, the error in the gain is periodic, that is, it shows a small ripple. (Note that there is also a variation in the output offset voltage, which is due to the gain interpolation, but this is not exact in amplitude.) By offsetting the gains of A1 and A2 by half the period of the ripple, that is, by 3 dB, the residual gain errors of the two amplifiers can be made to cancel. Figure 45 shows much lower gain ripple when configured in this manner. Figure 46 plots the ISNR as a function of gain; it is very similar to that in the parallel mode.

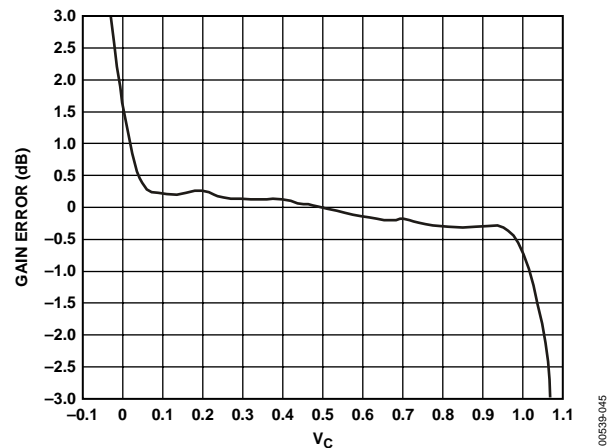

Figure 45. Gain Error for Cascaded Stages—Low Ripple Mode



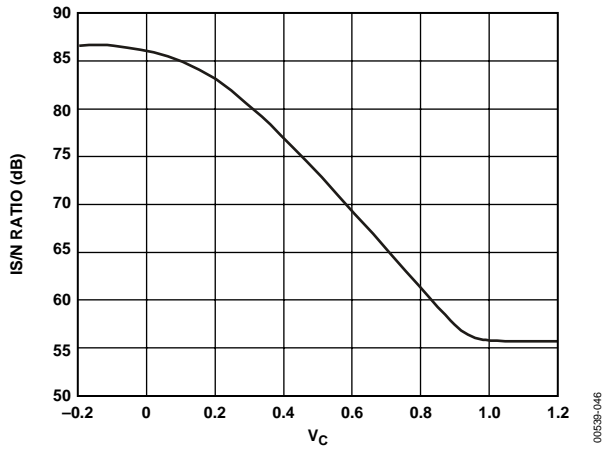

Figure 46. ISNR vs. Control Voltage—Low Ripple Mode



During the time  $V_{OUT}$  is negative with respect to the base voltage of Q1, Q1 conducts; when  $V_{OUT}$  is positive, it is cut off. Since the average collector current of Q1 is forced to be  $300\ \mu\text{A}$ , and the square wave has a duty cycle of 1:1, Q1's collector current when conducting must be  $600\ \mu\text{A}$ . With R8 omitted, the peak amplitude of  $V_{OUT}$  is forced to be just the  $V_{BE}$  of Q1 at  $600\ \mu\text{A}$ , typically about  $700\ \text{mV}$ , or  $2\ V_{BE}$  peak-to-peak. This voltage, the amplitude at which the output stabilizes, has a strong negative temperature coefficient (TC), typically  $-1.7\ \text{mV}/^\circ\text{C}$ . Although this may not be troublesome in some applications, the correct value of R8 will render the output stable with temperature.

To understand this, note that the current in Q2 is made to be proportional to absolute temperature (PTAT). For the moment, continue to assume that the signal is a square wave.

When Q1 is conducting,  $V_{OUT}$  is now the sum of  $V_{BE}$  and a voltage that is PTAT and that can be chosen to have an equal but opposite TC to that of the  $V_{BE}$ . This is actually nothing more than an application of the band gap voltage reference principle. When R8 is chosen such that the sum of the voltage across it and the  $V_{BE}$  of Q1 is close to the band gap voltage of about  $1.2\ \text{V}$ ,  $V_{OUT}$  will be stable over a wide range of temperatures, provided, of course, that Q1 and Q2 share the same thermal environment.

Since the average emitter current is  $600\ \mu\text{A}$  during each half cycle of the square wave, a resistor of  $833\ \Omega$  would add a PTAT voltage of  $500\ \text{mV}$  at  $300\ \text{K}$ , increasing by  $1.66\ \text{mV}/^\circ\text{C}$ . In practice, the optimum value will depend on the type of transistor used and, to a lesser extent, on the waveform for which the temperature stability is to be optimized; for the

inexpensive 2N3904/2N3906 pair and sine wave signals, the recommended value is  $806\ \Omega$ .

This resistor also serves to lower the peak current in Q1 when more typical signals (usually sinusoidal) are involved, and the  $1.8\ \text{kHz}$  LP filter it forms with  $C_{AV}$  helps to minimize distortion due to ripple in  $V_{AGC}$ . Note that the output amplitude under sine wave conditions will be higher than for a square wave, since the average value of the current for an ideal rectifier would be  $0.637$  times as large, causing the output amplitude to be  $1.88$  ( $= 1.2/0.637$ ) V, or  $1.33\ \text{V rms}$ . In practice, the somewhat nonideal rectifier results in the sine wave output being regulated to about  $1.4\ \text{V rms}$ , or  $3.6\ \text{V p-p}$ .

The bandwidth of the circuit exceeds  $40\ \text{MHz}$ . At  $10.7\ \text{MHz}$ , the AGC threshold is  $100\ \mu\text{V}$  ( $-67\ \text{dBm}$ ) and its maximum gain is  $83\ \text{dB}$  ( $20\ \log 1.4\ \text{V}/100\ \mu\text{V}$ ). The circuit holds its output at  $1.4\ \text{V rms}$  for inputs as low as  $-67\ \text{dBm}$  to  $+15\ \text{dBm}$  ( $82\ \text{dB}$ ), where the input signal exceeds the AD603's maximum input rating. For a  $30\ \text{dBm}$  input at  $10.7\ \text{MHz}$ , the second harmonic is  $34\ \text{dB}$  down from the fundamental and the third harmonic is  $35\ \text{dB}$  down.

### CAUTION

Careful component selection, circuit layout, power supply decoupling, and shielding are needed to minimize the AD603's susceptibility to interference from signals such as those from radio and TV stations. In bench evaluation, it is recommended to place all of the components into a shielded box and using feedthrough decoupling networks for the supply voltage. Circuit layout and construction are also critical, since stray capacitances and lead inductances can form resonant circuits and are a potential source of circuit peaking, oscillation, or both.

## OUTLINE DIMENSIONS

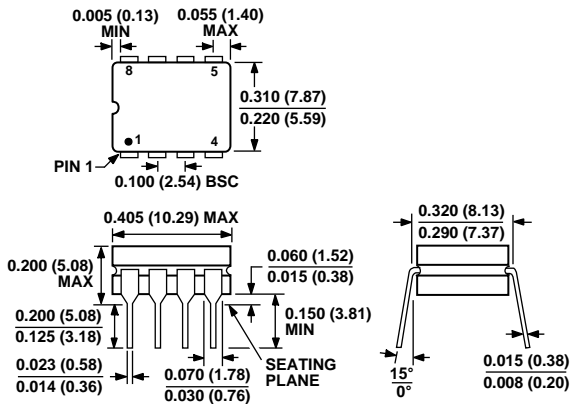

CONTROLLING DIMENSIONS ARE IN INCHES; MILLIMETER DIMENSIONS (IN PARENTHESES) ARE ROUNDED-OFF INCH EQUIVALENTS FOR REFERENCE ONLY AND ARE NOT APPROPRIATE FOR USE IN DESIGN.

Figure 48. 8-Lead Ceramic Dual In-Line Package [CERDIP] (Q-8)

Dimensions shown in inches and (millimeters)

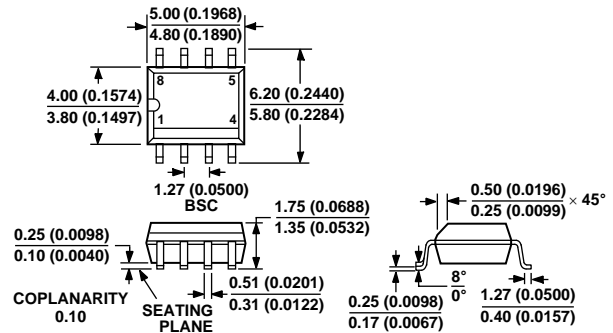

COMPLIANT TO JEDEC STANDARDS MS-012-AA  
CONTROLLING DIMENSIONS ARE IN MILLIMETERS; INCH DIMENSIONS (IN PARENTHESES) ARE ROUNDED-OFF MILLIMETER EQUIVALENTS FOR REFERENCE ONLY AND ARE NOT APPROPRIATE FOR USE IN DESIGN

Figure 49. 8-Lead Standard Small Outline Package [SOIC-N]

Narrow Body (R-8)

Dimensions shown in millimeters and (inches)

## ORDERING GUIDE

| Part Number                 | Temperature Range | Package Description   | Package Option |
|-----------------------------|-------------------|-----------------------|----------------|
| AD603AR                     | -40°C to +85°C    | 8-Lead SOIC           | R-8            |
| AD603AR-REEL                | -40°C to +85°C    | 8-Lead SOIC, 13" Reel | R-8            |
| AD603AR-REEL7               | -40°C to +85°C    | 8-Lead SOIC, 7" Reel  | R-8            |
| AD603ARZ <sup>1</sup>       | -40°C to +85°C    | 8-Lead SOIC           | R-8            |
| AD603ARZ-REEL <sup>1</sup>  | -40°C to +85°C    | 8-Lead SOIC, 13" Reel | R-8            |
| AD603ARZ-REEL7 <sup>1</sup> | -40°C to +85°C    | 8-Lead SOIC, 7" Reel  | R-8            |
| AD603AQ                     | -40°C to +85°C    | 8-Lead CERDIP         | Q-8            |
| AD603SQ/883B <sup>2</sup>   | -55°C to +125°C   | 8-Lead CERDIP         | Q-8            |
| AD603-EB                    |                   | Evaluation Board      |                |
| AD603ACHIPS                 |                   | DIE                   |                |

<sup>1</sup> Z = Pb-free part.

<sup>2</sup> Refer to AD603 Military data sheet. Also available as 5962-9457203MPA.