

### FEATURES

- On-Chip Reference and Track/Hold
- On-Chip Input Buffer
- 850 mW Typical Power Dissipation at 105 MSPS
- 500 MHz Analog Bandwidth
- SNR = 67 dB @ 49 MHz AIN at 105 MSPS
- SFDR = 80 dB @ 49 MHz AIN at 105 MSPS
- 2.0 V p-p Differential Analog Input Range
- Single 5.0 V Supply Operation
- 3.3 V CMOS/TTL Outputs
- Two's Complement Output Format

### APPLICATIONS

- Communications
- Basestations and 'Zero-IF' Subsystems
- Wireless Local Loop (WLL)
- Local Multipoint Distribution Service (LMDS)
- HDTV Broadcast Cameras and Film Scanners

### GENERAL INTRODUCTION

The AD9432 is a 12-bit monolithic sampling analog-to-digital converter with an on-chip track-and-hold circuit and is optimized for high-speed conversion and ease of use. The product operates at a 105 MSPS conversion rate with outstanding dynamic performance over its full operating range.

The ADC requires only a single 5.0 V power supply and a 105 MHz encode clock for full-performance operation. No

### FUNCTIONAL BLOCK DIAGRAM

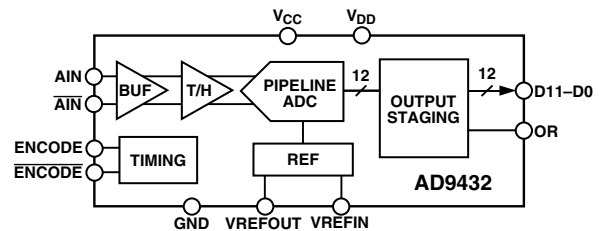

external reference or driver components are required for many applications. The digital outputs are TTL/CMOS compatible and a separate output power supply pin supports interfacing with 3.3 V logic. The encode input supports either differential or single-ended and is TTL/CMOS-compatible.

Fabricated on an advanced BiCMOS process, the AD9432 is available in a 52-lead plastic quad flatpack package (LQFP) specified over the industrial temperature range (-40°C to +85°C).

### REV. E

Information furnished by Analog Devices is believed to be accurate and reliable. However, no responsibility is assumed by Analog Devices for its use, nor for any infringements of patents or other rights of third parties that may result from its use. No license is granted by implication or otherwise under any patent or patent rights of Analog Devices.

# AD9432—SPECIFICATIONS

( $V_{DD} = 3.3\text{ V}$ ,  $V_{CC} = 5.0\text{ V}$ ; external reference; differential encode input, unless otherwise noted.)

Parameter	Temp	Test Level	AD9432BST/BSQ-80			AD9432BST/BSQ-105			Unit
			Min	Typ	Max	Min	Typ	Max	
RESOLUTION			12			12			Bits
DC ACCURACY									
Differential Nonlinearity	25°C	I	-0.75	±0.25	+0.75	-0.75	±0.25	+0.75	LSB
	Full	VI	-1.0	±0.5	+1.0	-1.0	±0.5	+1.0	LSB
Integral Nonlinearity	25°C	I	-1.0	±0.5	+1.0	-1.0	±0.5	+1.0	LSB
	Full	VI	-1.5	±1.0	+1.5	-1.5	±1.0	+1.5	LSB
No Missing Codes	Full	VI	Guaranteed			Guaranteed			
Gain Error <sup>1</sup>	25°C	I	-5	+2	+7	-5	+2	+7	% FS
Gain Tempco <sup>1</sup>	Full	V	150			150			ppm/°C
ANALOG INPUT									
Input Voltage Range ( $A_{IN}-\overline{A_{IN}}$ )	Full	V	±1.0			±1.0			V
Common-Mode Voltage	Full	V	3.0			3.0			V
Input Offset Voltage	Full	VI	-5	±0	+5	-5	±0	+5	mV
Input Resistance	Full	VI	2	3	4	2	3	4	kΩ
Input Capacitance	25°C	V	4			4			pF
Analog Bandwidth, Full Power	25°C	V	500			500			MHz
ANALOG REFERENCE									
Output Voltage	Full	VI	2.4	2.5	2.6	2.4	2.5	2.6	V
Tempco	Full	V	50			50			ppm/°C
Input Bias Current	Full	VI	15			15			μA
SWITCHING PERFORMANCE									
Maximum Conversion Rate	Full	VI	80			105			MSPS
Minimum Conversion Rate	Full	IV				1			MSPS
Encode Pulsewidth High ( $t_{EH}$ )	25°C	IV	4.0	6.2		4.0	4.8		ns
Encode Pulsewidth Low ( $t_{EL}$ )	25°C	IV	4.0	6.2		4.0	4.8		ns
Aperture Delay ( $t_A$ )	25°C	V	2.0			2.0			ns
Aperture Uncertainty (Jitter)	25°C	V	0.25			0.25			ps rms
Output Valid Time ( $t_V$ ) <sup>2</sup>	Full	VI	3.0	5.3		3.0	5.3		ns
Output Propagation Delay ( $t_{PD}$ ) <sup>2</sup>	Full	VI	5.5			5.5			8.0
Output Rise Time ( $t_R$ ) <sup>2</sup>	Full	V	2.1			2.1			ns
Output Fall Time ( $t_F$ )	Full	V	1.9			1.9			ns
Out-of-Range Recovery Time	25°C	V	2			2			ns
Transient Response Time	25°C	V	2			2			ns
Latency	Full	IV	10			10			Cycles
DIGITAL INPUTS									
Encode Input Common Mode	Full	V	1.6			1.6			V
Differential Input ( $ENC-\overline{ENC}$ )	Full	V	750			750			mV
Single-Ended									
Logic "1" Voltage	Full	IV	2.0			2.0			V
Logic "0" Voltage	Full	IV	0.8			0.8			V
Input Resistance	Full	VI	3	5	8	3	5	8	kΩ
Input Capacitance	25°C	V	4.5			4.5			pF
DIGITAL OUTPUTS									
Logic "1" Voltage ( $V_{DD} = 3.3\text{ V}$ )	Full	VI	$V_{DD} - 0.05$			$V_{DD} - 0.05$			V
Logic "0" Voltage ( $V_{DD} = 3.3\text{ V}$ )	Full	VI	0.05			0.05			V
Output Coding			Two's Complement			Two's Complement			
POWER SUPPLY									
Power Dissipation <sup>3</sup>	Full	VI	790			850			mW
Power Supply Rejection Ratio (PSRR)	25°C	I	-5	+0.5	+5	-5	+0.5	+5	mV/V
$I_{VCC}$	Full	VI	158			170			mA
$I_{VDD}$	Full	VI	9.5			12.5			mA

Parameter	Temp	Test Level	AD9432BST/BSQ-80			AD9432BST/BSQ-105			Unit
			Min	Typ	Max	Min	Typ	Max	
<b>DYNAMIC PERFORMANCE<sup>4</sup></b>									
Signal-to-Noise Ratio (SNR) (Without Harmonics)									
$f_{IN} = 10.3 \text{ MHz}$	25°C	I	65.5	67.5		65.5	67.5		dB
$f_{IN} = 40 \text{ MHz}$	25°C	I	65	67.2			67.2		dB
$f_{IN} = 49 \text{ MHz}$	25°C	I		67.0		64	67.0		dB
$f_{IN} = 70 \text{ MHz}$	25°C	V		66.1			66.1		dB
Signal-to-Noise Ratio (SINAD) (With Harmonics)									
$f_{IN} = 10.3 \text{ MHz}$	25°C	I	65	67.2		65	67.2		dB
$f_{IN} = 40 \text{ MHz}$	25°C	I	64.5	66.9			66.9		dB
$f_{IN} = 49 \text{ MHz}$	25°C	I		66.7		63	66.7		dB
$f_{IN} = 70 \text{ MHz}$	25°C	V		65.8			65.8		dB
Effective Number of Bits									
$f_{IN} = 10 \text{ MHz}$	25°C	V		11.0			11.0		Bits
$f_{IN} = 40 \text{ MHz}$	25°C	V		10.9			10.9		Bits
$f_{IN} = 49 \text{ MHz}$	25°C	V		10.9			10.9		Bits
$f_{IN} = 70 \text{ MHz}$	25°C	V		10.7			10.7		Bits
Second and Third Harmonic Distortion									
$f_{IN} = 10 \text{ MHz}$	25°C	I	-75	-85		-75	-85		dBc
$f_{IN} = 40 \text{ MHz}$	25°C	I	-73	-85			-83		dBc
$f_{IN} = 49 \text{ MHz}$	25°C	I		-83		-72	-80		dBc
$f_{IN} = 70 \text{ MHz}$	25°C	V		-80			-78		dBc
Worst Harmonic or Spur (Excluding Second and Third)									
$f_{IN} = 10 \text{ MHz}$	25°C	I	-80	-90		-80	-90		dBc
$f_{IN} = 40 \text{ MHz}$	25°C	I	-80	-90			-90		dBc
$f_{IN} = 49 \text{ MHz}$	25°C	I		-90		-80	-90		dBc
$f_{IN} = 70 \text{ MHz}$	25°C	V		-90			-90		dBc
Two-Tone Intermod Distortion (IMD)									
$f_{IN1} = 29.3 \text{ MHz}; f_{IN2} = 30.3 \text{ MHz}$	25°C	V		-75			-75		dBc
$f_{IN1} = 70.3 \text{ MHz}; f_{IN2} = 71.3 \text{ MHz}$	25°C	V		-66			-66		dBc

## NOTES

<sup>1</sup>Gain error and gain temperature coefficients are based on the ADC only (with a fixed 2.5 V external reference and a 2 V p-p differential analog input).

<sup>2</sup> $t_V$  and  $t_{PD}$  are measured from the transition points of the ENCODE input to the 50%/50% levels of the digital outputs swing. The digital output load during test is not to exceed an ac load of 10 pF or a dc current of  $\pm 40 \mu\text{A}$ . Rise and fall times measured from 10% to 90%.

<sup>3</sup>Power dissipation measured with encode at rated speed and a dc analog input. (Outputs Static,  $I_{VDD} = 0$ .)

<sup>4</sup>SNR/harmonics based on an analog input voltage of -0.5 dBFS referenced to a 2 V full-scale input range.

Specifications subject to change without notice.

# AD9432

## ABSOLUTE MAXIMUM RATINGS\*

V <sub>DD</sub>	6 V
V <sub>CC</sub>	6 V
Analog Inputs	-0.5 V to V <sub>CC</sub> + 0.5 V
Digital Inputs	-0.5 V to V <sub>DD</sub> + 0.5 V
VREFIN	-0.5 V to V <sub>CC</sub> + 0.5 V
Digital Output Current	20 mA
Operating Temperature	-55°C to +125°C
Storage Temperature	-65°C to +150°C
Maximum Junction Temperature	150°C
Maximum Case Temperature	150°C

\*Stresses above those listed under Absolute Maximum Ratings may cause permanent damage to the device. This is a stress rating only; functional operation of the device at these or any other conditions outside of those indicated in the operation sections of this specification is not implied. Exposure to absolute maximum ratings for extended periods may affect device reliability.

## EXPLANATION OF TEST LEVELS

### Test Level

- I 100% production tested.
- II 100% production tested at 25°C and sample tested at specified temperatures.
- III Sample tested only.
- IV Parameter is guaranteed by design and characterization testing.
- V Parameter is a typical value only.
- VI 100% production tested at 25°C; guaranteed by design and characterization testing for industrial temperature range.

## CAUTION

ESD (electrostatic discharge) sensitive device. Electrostatic charges as high as 4000 V readily accumulate on the human body and test equipment and can discharge without detection. Although the AD9432 features proprietary ESD protection circuitry, permanent damage may occur on devices subjected to high-energy electrostatic discharges. Therefore, proper ESD precautions are recommended to avoid performance degradation or loss of functionality.

## THERMAL CHARACTERISTICS

52-Lead Plastic LQFP (ST-52)

$\theta_{JA} = 50^{\circ}\text{C/W}$ , No Airflow

52-lead PowerQuad® 4 LQFP (SQ-52)

$\theta_{JA} = 25^{\circ}\text{C/W}$ , Soldered Exposed Heat Sink, No Airflow

$\theta_{JA} = 33^{\circ}\text{C/W}$ , Unsoldered Exposed Heat Sink, No Airflow

$\theta_{JC} = 2^{\circ}\text{C/W}$ , Bottom of package (Exposed Heat Sink)

Simulated Typical performance for 4-layer JEDEC board, horizontal orientation.

## ORDERING GUIDE

Model	Temperature Ranges	Package Descriptions	Package Option
AD9432BSQ -80, -105	-40°C to +85°C	52-Lead Thermally Enhanced Plastic Quad Flatpack	SQ-52
AD9432BST -80, -105	-40°C to +85°C	52-Lead Plastic Quad Flatpack (LQFP)	ST-52
AD9432/PCB	25°C	Evaluation Board	



## PIN CONFIGURATION

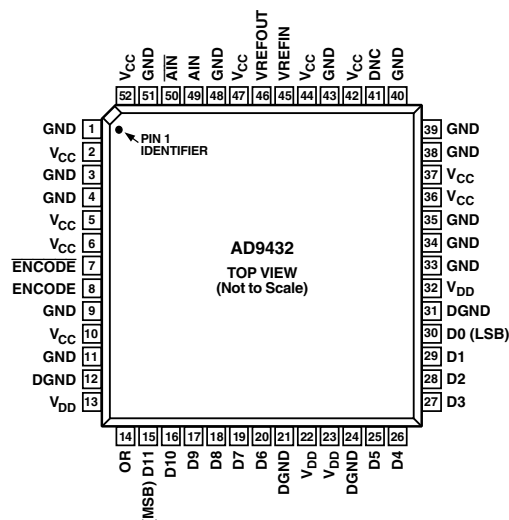

## PIN FUNCTION DESCRIPTIONS

Pin Number (AD9432BST)	Mnemonic	Function
1, 3, 4, 9, 11, 33, 34, 35, 38, 39, 40, 43, 48, 51	GND	Analog Ground
2, 5, 6, 10, 36, 37, 42, 44, 47, 52	V <sub>CC</sub>	Analog Supply (5 V)
7	ENCODE	Encode Clock for ADC—Complementary
8	ENCODE	Encode Clock for ADC—True (ADC samples on rising edge of ENCODE)
14	OR	Out of Range Output
15–20, 25–30	D11–D6, D5–D0	Digital Output
12, 21, 24, 31	DGND	Digital Output Ground
13, 22, 23, 32	V <sub>DD</sub>	Digital Output Power Supply (2.7 V to 3.6 V)
41	DNC	Do Not Connect
45	VREFIN	Reference Input for ADC (2.5 V Typical); Bypass with 0.1 μF to Ground.
46	VREFOUT	Internal Reference Output (2.5 V Typical)
49	AIN	Analog Input—True
50	AIN	Analog Input—Complementary

## DEFINITION OF SPECIFICATIONS

**Analog Bandwidth (Small Signal)**

The analog input frequency at which the spectral power of the fundamental frequency (as determined by the FFT analysis) is reduced by 3 dB.

**Aperture Delay**

The delay between a differential crossing of ENCODE and ENCODE and the instant at which the analog input is sampled.

**Aperture Uncertainty (Jitter)**

The sample-to-sample variation in aperture delay.

**Differential Nonlinearity**

The deviation of any code from an ideal 1 LSB step.

**Encode Pulsewidth/Duty Cycle**

Pulsewidth high is the minimum amount of time that the ENCODE pulse should be left in Logic “1” state to achieve rated performance; pulsewidth low is the minimum time ENCODE pulse should be left in low state. At a given clock rate, these specs define an acceptable Encode duty cycle.

**Integral Nonlinearity**

The deviation of the transfer function from a reference line measured in fractions of 1 LSB using a “best straight line” determined by a least square curve fit.

**Minimum Conversion Rate**

The encode rate at which the SNR of the lowest analog signal frequency drops by no more than 3 dB below the guaranteed limit.

**Maximum Conversion Rate**

The encode rate at which parametric testing is performed.

**Output Propagation Delay**

The delay between a differential crossing of ENCODE and ENCODE and the time when all output data bits are within valid logic levels.

**Power Supply Rejection Ratio**

The ratio of a change in input offset voltage to a change in power supply voltage.

**Signal-to-Noise Plus Distortion (SINAD)**

The ratio of the rms signal amplitude (set at 1 dB below full scale) to the rms value of the sum of all other spectral components, including harmonics but excluding dc.

**Signal-to-Noise Ratio (SNR)**

The ratio of the rms signal amplitude (set at 1 dB below full scale) to the rms value of the sum of all other spectral components, excluding the first five harmonics and dc.

# AD9432

## Spurious-Free Dynamic Range (SFDR)

The ratio of the rms signal amplitude to the rms value of the peak spurious spectral component. The peak spurious component may or may not be a harmonic. May be reported in dBc (i.e., degrades as signal level is lowered), or in dBFS (always related back to converter full scale).

## Two-Tone Intermodulation Distortion Rejection

The ratio of the rms value of either input tone to the rms value of the worst third order intermodulation product; reported in dBc.

## Two-Tone SFDR

The ratio of the rms value of either input tone to the rms value of the peak spurious component. The peak spurious component may or may not be an IMD product. May be reported in dBc (i.e., degrades as signal level is lowered), or in dBFS (always related back to converter full scale).

## Worst Harmonic

The ratio of the rms signal amplitude to the rms value of the worst harmonic component, reported in dBc.

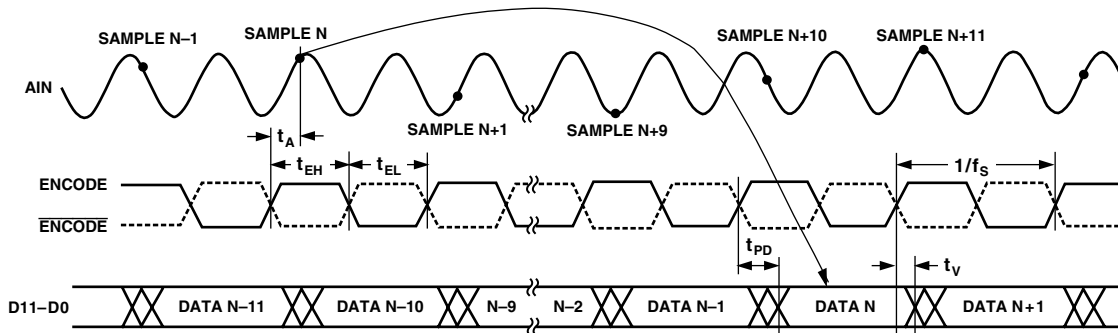

Figure 1. Timing Diagram

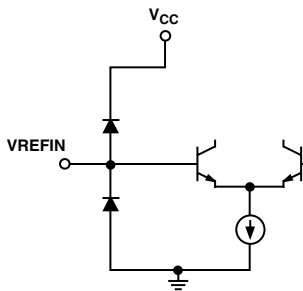

Figure 2. Equivalent Voltage Reference Input Circuit

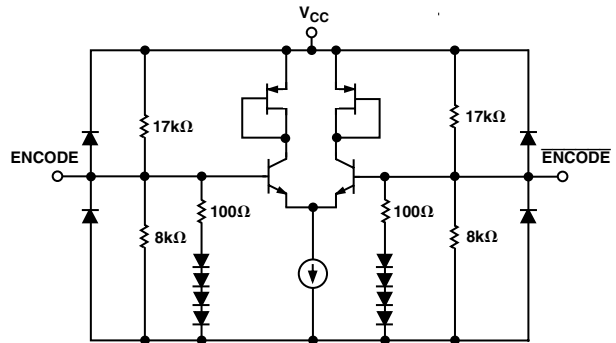

Figure 4. Equivalent Encode Input Circuit

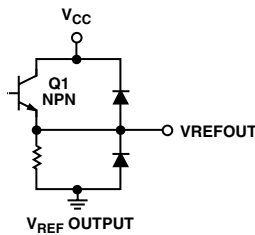

Figure 3. Equivalent Voltage Reference Output Circuit

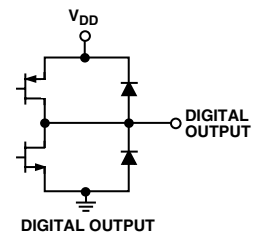

Figure 5. Equivalent Digital Output Circuit

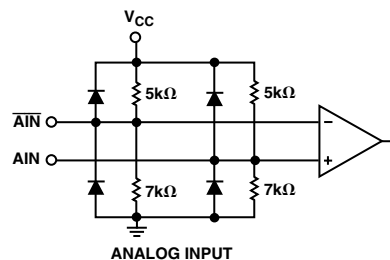
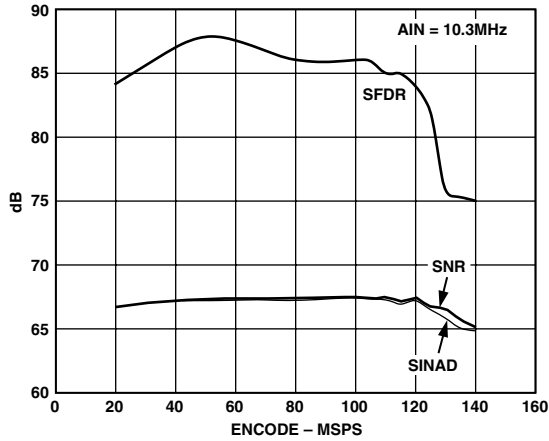
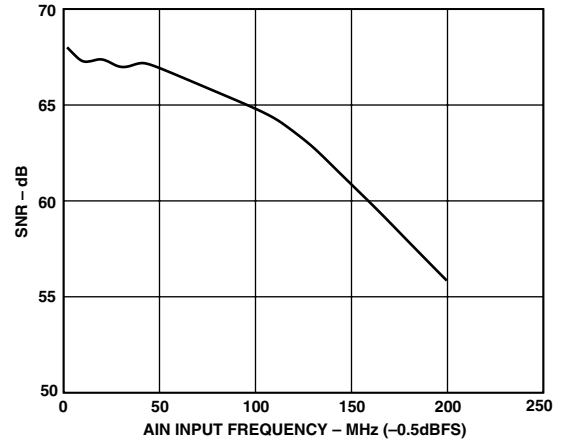

Figure 6. Equivalent Analog Input Circuit

# Typical Performance Characteristics—AD9432



TPC 1. SNR/SINAD/SFDR vs.  $f_s$ :  $f_{IN} = 10.3$  MHz



TPC 4. SNR vs. AIN Input Frequency, Encode = 105 MSPS

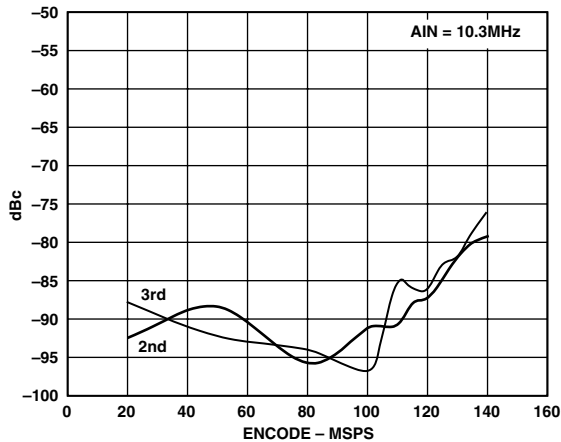

TPC 2. Harmonics vs.  $f_s$ :  $f_{IN} = 10.3$  MHz

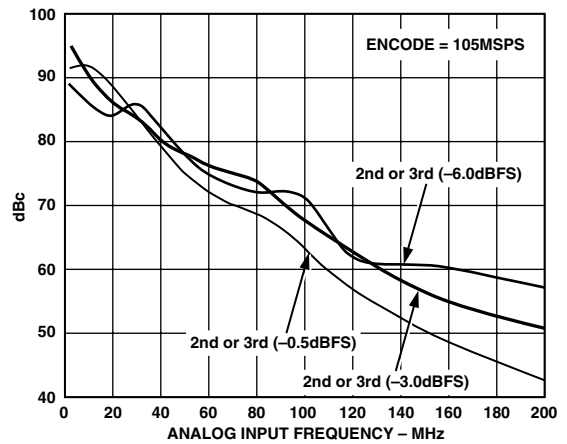

TPC 5. Harmonics vs.  $f_{IN}$ :  $f_s = 105$  MSPS

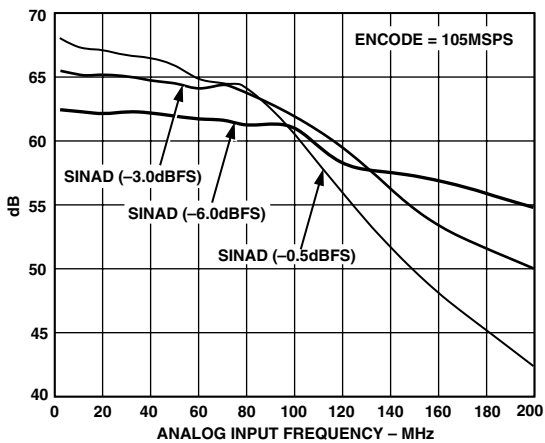

TPC 3. SINAD vs.  $f_{IN}$ :  $f_s = 105$  MSPS

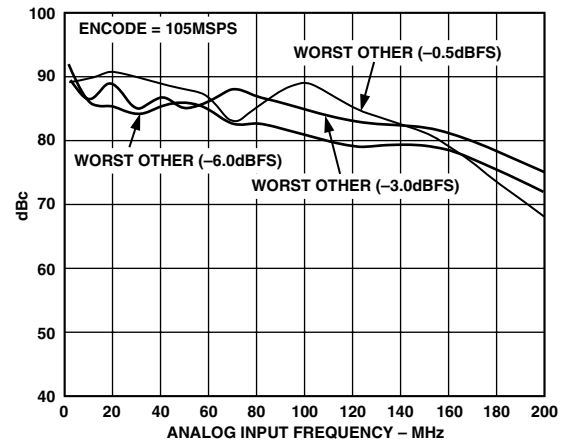

TPC 6. Worst-Case Spur (Other than Second and Third) vs.  $f_{IN}$ :  $f_s = 105$  MSPS

# AD9432

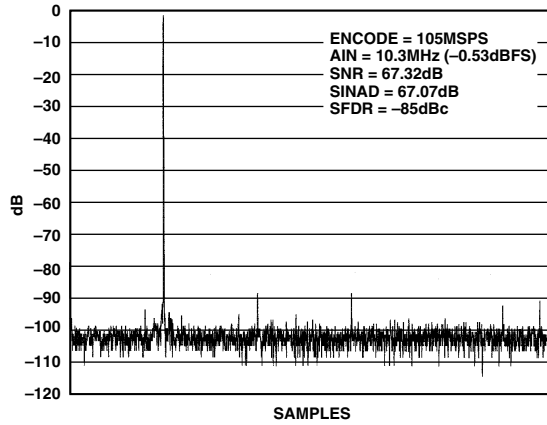

TPC 7. Spectrum:  $f_S = 105 \text{ MSPS}$ ,  $f_{IN} = 10.3 \text{ MHz}$

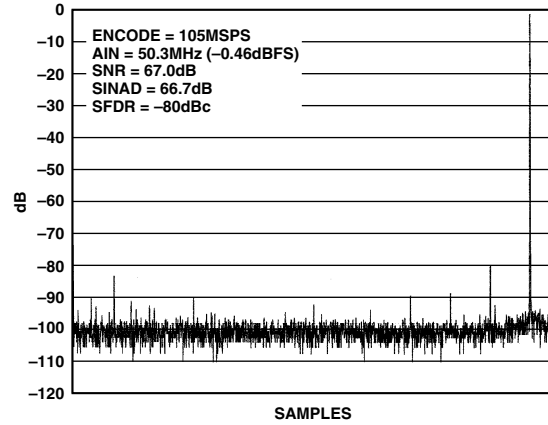

TPC 10. Spectrum:  $f_S = 105 \text{ MSPS}$ ,  $f_{IN} = 50.3 \text{ MHz}$

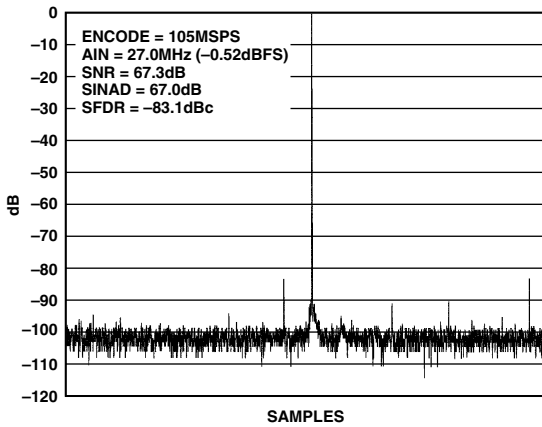

TPC 8. Spectrum:  $f_S = 105 \text{ MSPS}$ ,  $f_{IN} = 27 \text{ MHz}$

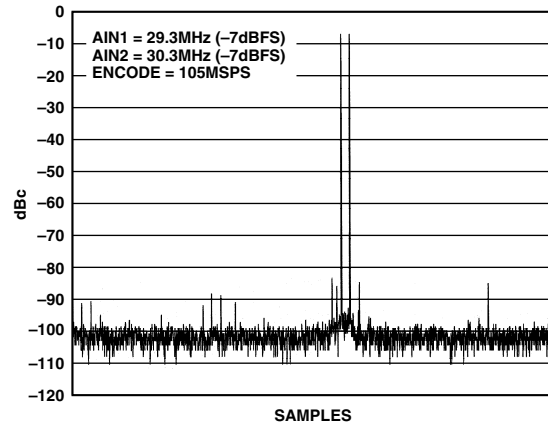

TPC 11. Two-Tone Spectrum, Wideband:  $f_S = 105 \text{ MSPS}$ ,  $AIN1 = 29.3 \text{ MHz}$ ,  $AIN2 = 30.3 \text{ MHz}$

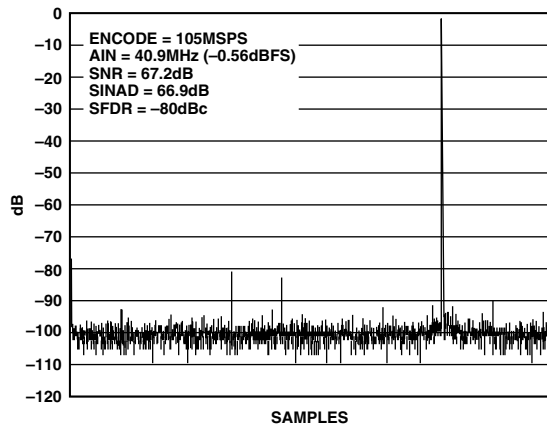

TPC 9. Spectrum:  $f_S = 105 \text{ MSPS}$ ,  $f_{IN} = 40.9 \text{ MHz}$

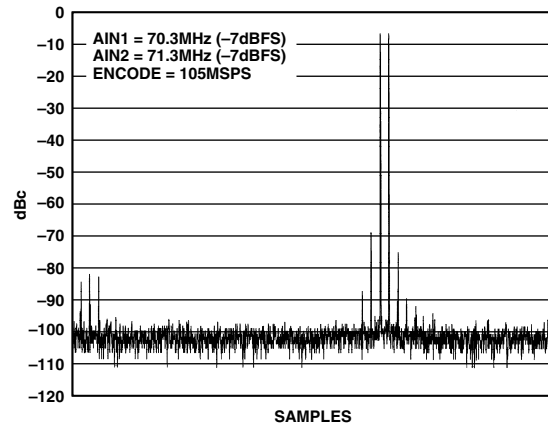

TPC 12. Two-Tone Spectrum, Wideband:  $f_S = 105 \text{ MSPS}$ ,  $AIN1 = 70.3 \text{ MHz}$ ,  $AIN2 = 71.3 \text{ MHz}$



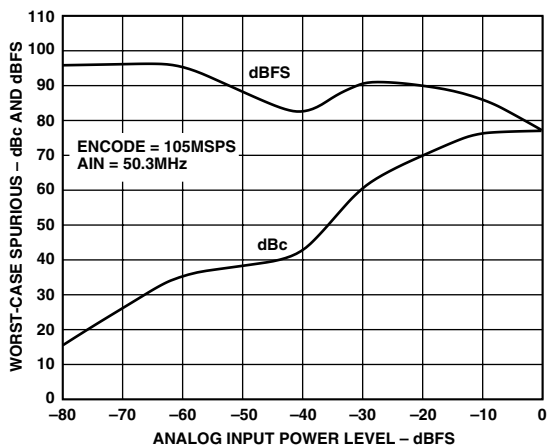

TPC 13. Single Tone SFDR

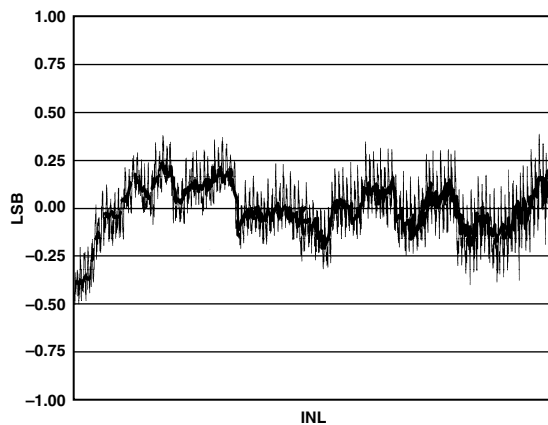

TPC 15. Integral Nonlinearity:  $f_s = 105$  MSPS

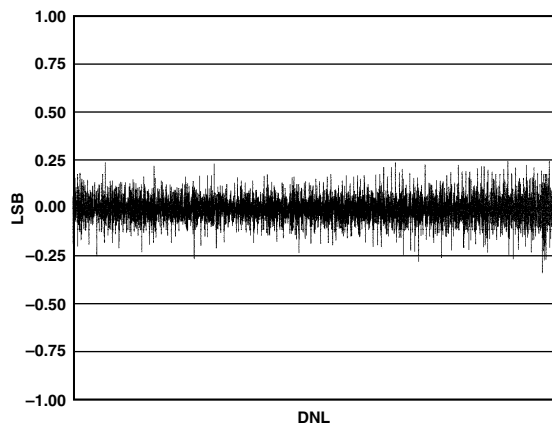

TPC 14. Differential Nonlinearity:  $f_s = 105$  MSPS

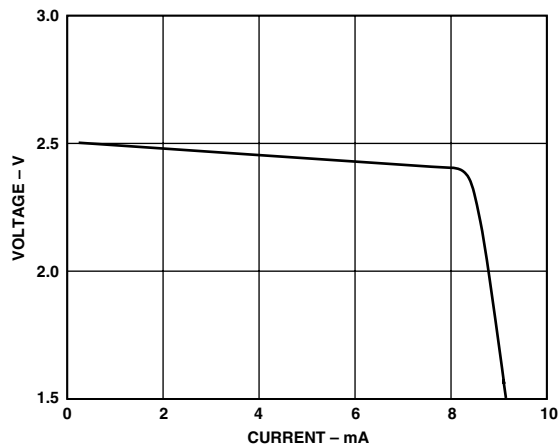

TPC 16. Voltage Reference Output vs. Current Load

# AD9432

## APPLICATION NOTES

### Theory of Operation

The AD9432 is a multibit pipeline converter that uses a switched capacitor architecture. Optimized for high speed, this converter provides flat dynamic performance up to frequencies near Nyquist. DNL transitional errors are calibrated at final test to a typical accuracy of 0.25 LSB or less.

## USING THE AD9432

### Analog Input

The analog input to the AD9432 is a differential buffer. The input buffer is self-biased by an on-chip resistor divider that sets the dc common-mode voltage to a nominal 3 V (see Equivalent Circuits section). Rated performance is achieved by driving the input differentially. Minimum input offset voltage is obtained when driving from a source with a low differential source impedance such as a transformer in ac applications. Capacitive coupling at the inputs will increase the input offset voltage by as much as  $\pm 25$  mV. Driving the ADC single-endedly will degrade performance. For best dynamic performance, impedances at  $A_{IN}$  and  $\overline{A_{IN}}$  should match.

Special care was taken in the design of the analog input section of the AD9432 to prevent damage and corruption of data when the input is overdriven. The nominal input range is 2 V p-p. Each analog input will be 1 V p-p when driven differentially.

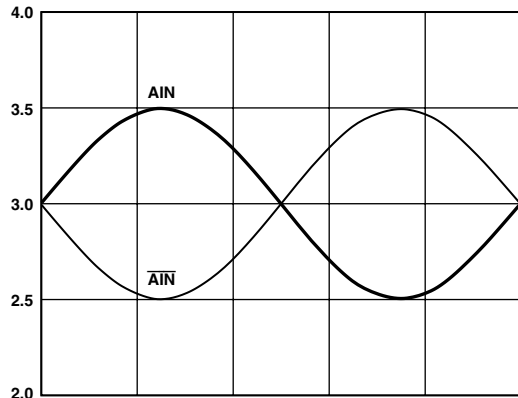

Figure 7. Full-Scale Analog Input Range

### ENCODE Input

Any high speed A/D converter is extremely sensitive to the quality of the sampling clock provided by the user. A track/hold circuit is essentially a mixer, and any noise, distortion, or timing jitter on the clock will be combined with the desired signal at the A/D output. For that reason, considerable care has been taken in the design of the ENCODE input of the AD9432, and the user is advised to give commensurate thought to the clock source. The ENCODE input supports either differential or single-ended and is fully TTL/CMOS compatible.

Note that the ENCODE inputs cannot be driven directly from PECL level signals ( $V_{IHD}$  is 3.5 V max). PECL level signals can easily be accommodated by ac coupling as shown in Figure 8. Good performance is obtained using an MC10EL16 in the circuit to drive the encode inputs.

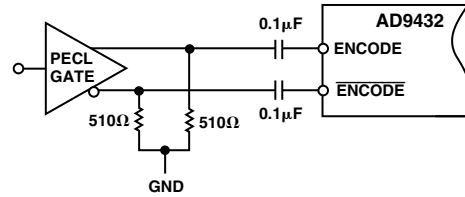

Figure 8. AC Coupling to ENCODE Inputs

### ENCODE Voltage Level Definition

The voltage level definitions for driving ENCODE and  $\overline{ENCODE}$  in single-ended and differential mode are shown in Figure 9.

#### ENCODE Inputs

Differential Signal Amplitude ( $V_{ID}$ )	500 mV min
	750 mV nom
High Differential Input Voltage ( $V_{IHD}$ )	3.5 V max
Low Differential Input Voltage ( $V_{ILD}$ )	0 V min
Common-Mode Input ( $V_{ICM}$ )	1.25 V min, 1.6 V nom
High Single-Ended Voltage ( $V_{IHS}$ )	2 V min to 3.5 V max
Low Single-Ended Voltage ( $V_{ILS}$ )	0 V min to 0.8 V max

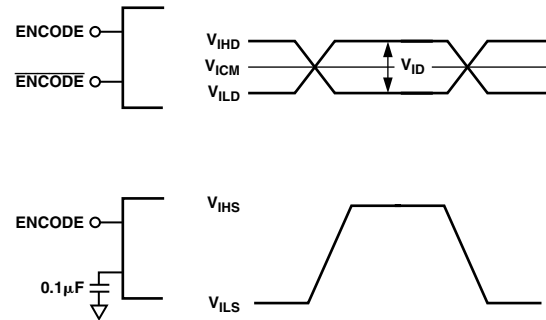

Figure 9. Differential and Single-Ended Input Levels

Often, the cleanest clock source is a crystal oscillator producing a pure sine wave. In this configuration, or with any roughly symmetrical clock input, the input can be ac-coupled and biased to a reference voltage that also provides the ENCODE. This ensures that the reference voltage is centered on the encode signal.

### Digital Outputs

The digital outputs are 3.3 V (2.7 V to 3.6 V) TTL/CMOS-compatible for lower power consumption. The output data format is Two's Complement, illustrated in Table I. The out of range (OR) output (logic LOW for normal operation) will be HIGH during any clock cycle when the ADC output data ( $D_x$ ) reach positive or negative full scale ( $-2048$  or  $+2047$ ). The OR is internally generated each clock cycle, has the same pipeline latency and propagation delay as the ADC output data, and will remain HIGH until the output data reflect an in-range condition. The ADC output bits ( $D_x$ ) will not roll over, and will therefore remain at positive or negative full scale ( $+2048$  or  $-2047$ ) while the OR output is HIGH.

**Table I. Output Coding (VREF = 2.5 V) (Two's Complement)**

Code	$A_{IN}-\overline{A_{IN}}$ (V)	Digital Output
+2047	1.000	0111 1111 1111
•	•	•
•	•	•
0	0	0000 0000 0000
-1	-0.00049	1111 1111 1111
•	•	•
•	•	•
-2048	-1.000	1000 0000 0000

### Voltage Reference

A stable and accurate 2.5 V voltage reference is built into the AD9432 (VREFOUT). In normal operation the internal reference is used by strapping Pin 45 to Pin 46 and placing a 0.1  $\mu\text{F}$  decoupling capacitor at VREFIN.

The input range can be adjusted by varying the reference voltage applied to the AD9432. No appreciable degradation in performance occurs when the reference is adjusted  $\pm 5\%$ . The full-scale range of the ADC tracks reference voltage changes linearly.

### Timing

The AD9432 provides latched data outputs, with 10 pipeline delays. Data outputs are included or available one propagation delay ( $t_{PD}$ ) after the rising edge of the encode command (see Figure 1). The length of the output data lines and loads placed on them should be minimized to reduce transients within the AD9432; these transients can detract from the converter's dynamic performance.

The minimum guaranteed conversion rate of the AD9432 is 1 MSPS. At internal clock rates below 1 MSPS, dynamic performance may degrade. Therefore, input clock rates below 1 MHz should be avoided.

During initial power-up, or whenever the clock to the AD9432 is interrupted, the output data will not be accurate data for 200 ns or 10 clock cycles, whichever is longer.

### Using the AD8138 to Drive the AD9432

A new differential output op amp from Analog Devices, Inc., the AD8138, can be used to drive the AD9432 in dc-coupled applications. The AD8138 was specifically designed for ADC driver applications. Superior SNR performance is maintained up to analog frequencies of 30 MHz. The AD8138 op amp provides single-ended-to-differential conversion, providing for a low-cost option to transformer coupling for ac applications as well.

The circuit in Figure 10 was breadboarded and the measured performance is shown in Figures 11 and 12. The figures shown are for  $\pm 5$  V supplies at the AD8138—performance dropped by about 1 dB–2 dB with a single 5 V supply at the AD8138.

Figure 11 shows SNR and SINAD for a  $-1$  dBFS analog input frequency varied from 2 MHz to 40 MHz with an encode rate of 105 MSPS. The measurements are for nominal conditions at room temperature. Figure 12 shows the second and third harmonic distortion under the same conditions.

The dc common-mode voltage for the AD8138 outputs can be adjusted via input  $V_{OCM}$  to provide the 3 V common-mode voltage the AD9432 inputs require.

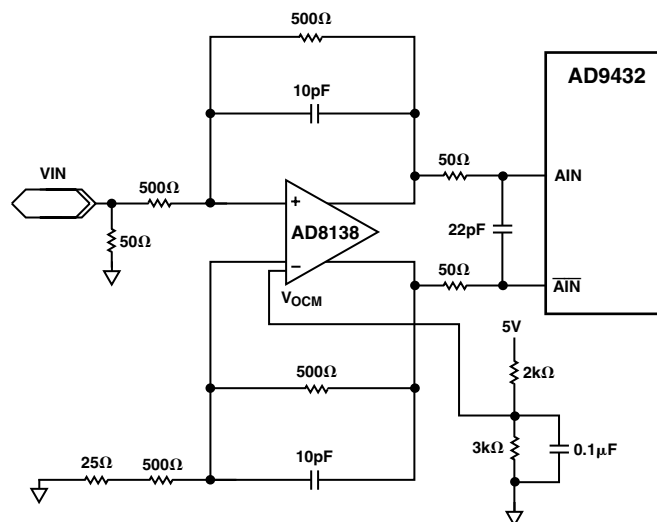

Figure 10. AD8138/AD9432 Schematic

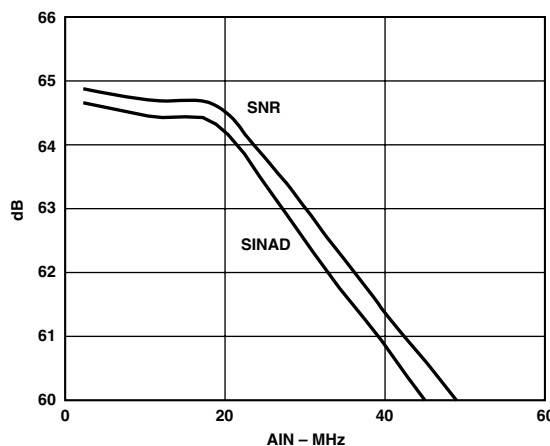

Figure 11. Measured SNR and SINAD (Encode = 105 MSPS)

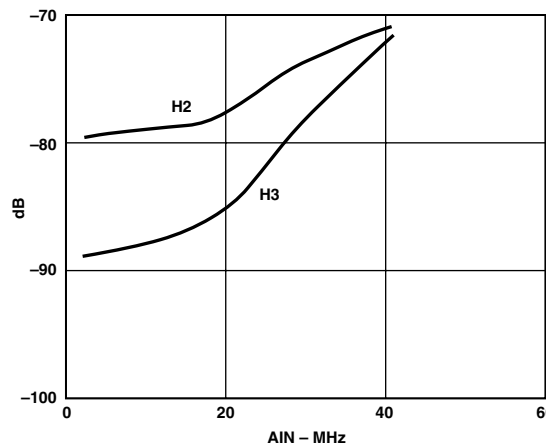

Figure 12. Measured Second and Third Order Harmonic Distortion (Encode = 105 MSPS)

# AD9432

## EVALUATION BOARD

The AD9432 evaluation board offers an easy way to test the AD9432. It requires an analog signal, encode clock, and power supplies as inputs. The clock is buffered on the board to provide the clocks for an on-board DAC and latches. The digital outputs and output clock are available at a standard 37-pin connector P7.

### Power Connector

Power is supplied to the board via two detachable 4-pin power strips P30, P40.

#### P40

P1	VCC2	5 V/165 mA	DAC Supply
P2	GND		
P3	VCC	5 V/200 mA	ADC Analog Supply
P4	GND		

#### P30

P5			No Connect
P6			No Connect
P7	VD	3.3 V / 105 mA	Latch, ADC Digital Output Supply
P8	GND		

### Analog Inputs

The evaluation board accepts a 2 V p-p analog input signal at SMB connector P2. This single-ended signal is ac-coupled by capacitor C11 and drives a wideband RF transformer T1 (Mini-Circuits ADT1-1WT) that converts the single-ended signal to a differential signal. (*The AD9432 should be driven differentially to provide optimum performance.*) The evaluation board is shipped with termination resistors R4, R5, which provide the effective 50 Ω termination impedance; input termination resistor R10 is optional. Note: The second harmonic distortion that some RF transformers tend to introduce at high frequencies can be reduced by coupling two transformers in series as shown in Figure 13. (Improvements on the order of 3 dB–4 dB can be realized.)

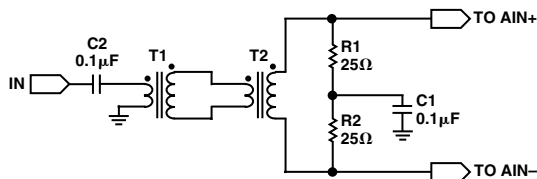

Figure 13. Improving Second Harmonic Distortion Performance

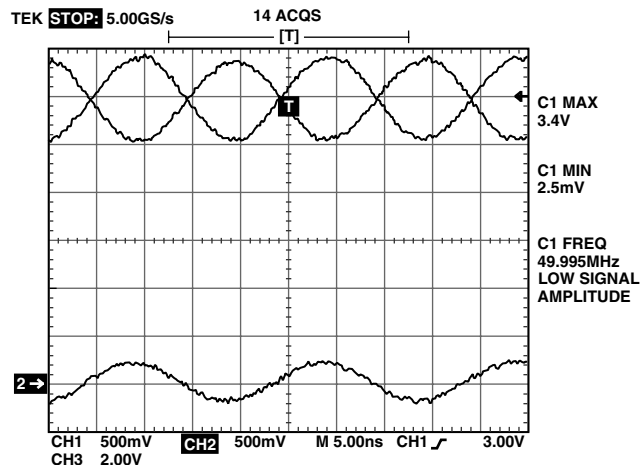

Figure 14. Analog Input Levels

The full-scale analog inputs to the ADC should be two 1 V p-p signals 180 degrees out of phase with each other, as shown in Figure 14. The analog inputs are dc biased by two on-chip resistor dividers that set the common-mode voltage to approximately  $0.6 \times VCC$  ( $0.6 \times 5 = 3$  V). AIN+ and AIN– each vary between 2.5 V and 3.5 V as shown in the two upper traces in Figure 14. The lower trace is the input at SMB P2 (*on a 2 V/div scale*).

### Encode

The encode input to the board is at SMB connector P3. The (>1 V p-p) input is ac-coupled and drives two high-speed differential line receivers (MC10EL16). These receivers provide subnanosecond rise times at their outputs—a requirement for the ADC clock inputs for optimum performance. The EL16 outputs are PECL levels and must be ac-coupled to meet the common-mode dc levels required at the AD9432 encode inputs. A PECL/TTL translator (MC100ELT23), provides the clocks required at the output latches, DAC, and 37-pin connector.

Note: Jitter performance on the clock source is critical at this performance level; a stable, crystal-controlled signal generator is used to generate all of the ADC performance plots. Figure 15 shows the Encode+ clock at the ADC. The 3 V latch clock generated on the card is also shown in the plot.

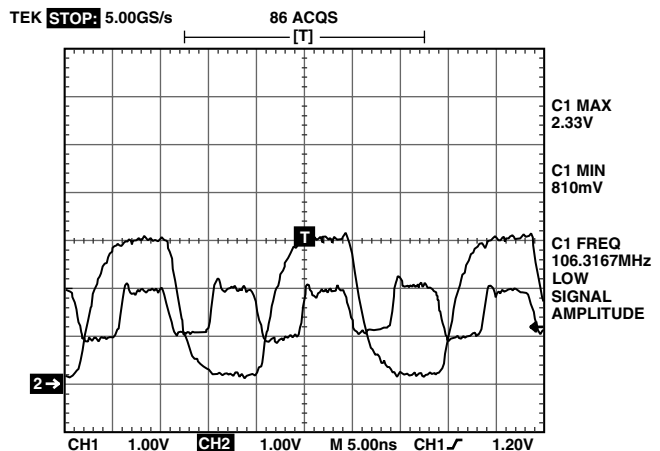

Figure 15. Encode+ Clock and Latch Clock

## DATA OUTPUTS

The ADC digital outputs are latched on the board by two 574s; the latch outputs are available at the 37-pin connector at Pins 25–36. A latch output clock (data ready) is available at Pin 21, with the complement at Pin 2. There are series termination resistors on the data and clock outputs. These can be changed if required to accommodate different loading situations. Figure 16 shows a data bit switching and output clock (DR) at the connector.

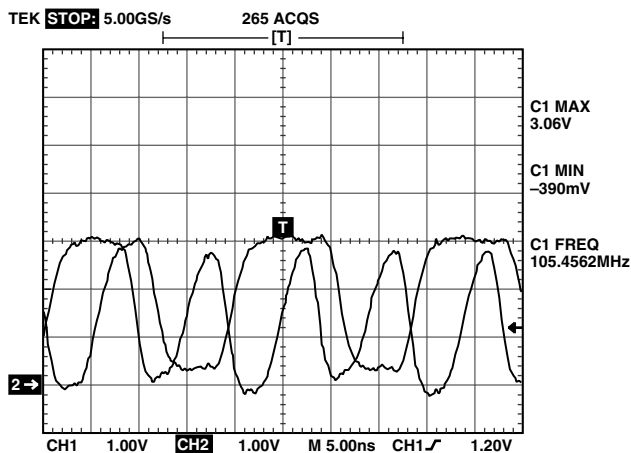

Figure 16. Data Bit and Clock at 37-Pin Connector

## REFERENCE

The AD9432 has an on-chip reference of 2.5 V available at VREFOUT (Pin 46). Most applications will simply tie this output to the VREFIN input (Pin 45). This is accomplished by jumping E4 to E6 on the board. An external voltage reference can drive the VREFIN pin if desired by strapping E4 to E3 and placing an AD780 voltage reference on the board (not supplied).

## DAC

The evaluation board has an on-board reconstruction DAC (AD9752). This is placed only to facilitate testing and debug of the board. It should not be used to measure the performance of the ADC, as it will not accurately indicate the ADC performance. The DAC output is available at SMB P1. It will drive a 50  $\Omega$  load. Provision to power down the DAC is at Pin 15 at the DAC.

## PCB LAYOUT

The PCB is designed on a four-layer (1 oz. Cu) board. Components and routing are on the top layer with a ground flood for additional isolation. Test and ground points were judiciously placed to facilitate high-speed probing. A common ground plane exists on the second layer. The third layer has three split power planes, two for the ADC and one for support logic. The DAC, components, and routing are located on the bottom layer.

## TROUBLESHOOTING

If the board does not seem to be working correctly, try the following:

- Verify power at IC pins.
- Check that all jumpers are in the correct position for the desired mode of operation.
- Verify VREF is at 2.5 V.
- Try running encode clock and analog inputs at low speeds (10 MSPS/1 MHz) and monitor 574 outputs, DAC output, and ADC outputs for toggling.

The AD9432 Evaluation Board is provided as a design example for customers of Analog Devices, Inc. ADI makes no warranties, express, statutory, or implied, regarding merchantability or fitness for a particular purpose.

# AD9432

## PCB Bill of Materials

#	Quantity	REFDES	Device	Package	Value
1	30	C1–C8, C10–C13, C17, C19–C22, C27–C29, C41, C42, C47, C48, C53, C56, C58, C60, C61, C70	Capacitor	603	0.1 $\mu$ F
2	1	C9	Capacitor	603	0.01 $\mu$ F
3	4	C14, C18, C31, C34	Capacitor	CAPTAJD	10 $\mu$ F
4	1	C15	Capacitor	CAPTAJD	1 $\mu$ F
5	18	E1–E13, E30, E32, E40, E42, E43	E-HOLE	Test Point	
6	3	P1, P2, P3	Connector	SMB	
7	1	P7	37-Pin Connector	Female	AMP 747462-2
8	2	P30, P40	Power Connector		
9	6	R1, R2, R7, R8, R10, R18 (R1, R2, R10 Optional)	Resistor	1206	50 $\Omega$
10	2	R3, R35	Resistor	1206	100 $\Omega$
11	4	R25, R26, R31, R32	Resistor	1206	500 $\Omega$
12	2	R6, R24	Resistor	1206	2 k $\Omega$
13	4	RP1–RP4	RES PAK		100 $\Omega$
14	1	T1	Transformer		Mini-Circuits ADT1-1WT
15	1	U1	DAC	SOIC	AD9752
16	1	U2	Reference (Not Supplied)	SOIC	AD780N
17	2	U3, U4	Inverter (U4 Not Supplied)	SC70	NC7SZ04P5
18	1	U9	ADC	52QFP	AD9432
19	2	U12–U13	Latch	SOIC	74AC574M
20	1	Z1	PECL/TTL Translator	SOIC	MC100ELT23
21	2	Z2, Z3	Differential Receiver	SOIC	MC10EL16
22	3	R4, R5, R15	Resistor	1206	24.9 $\Omega$

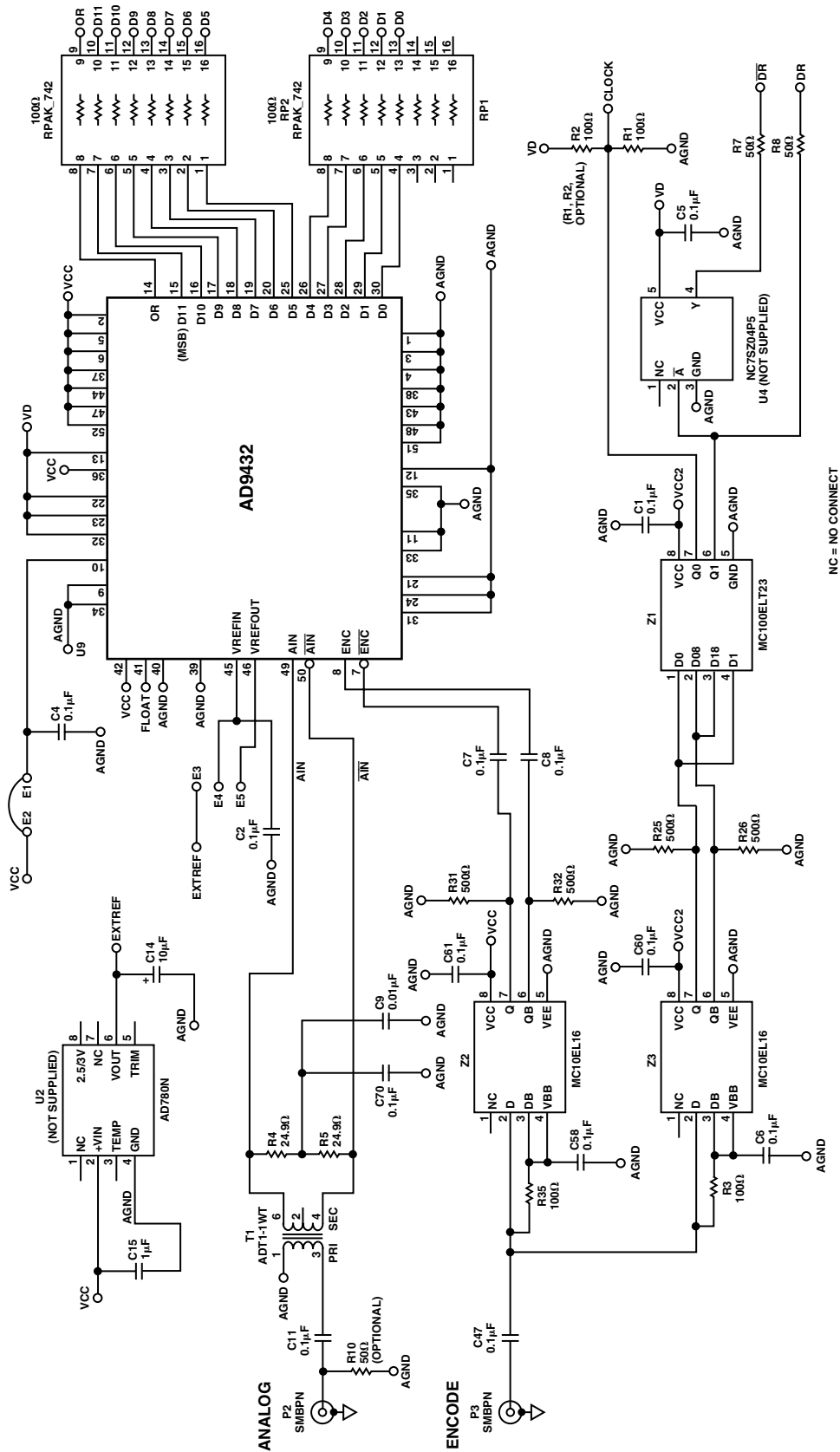

NC = NO CONNECT

Figure 17a. PCB Schematic

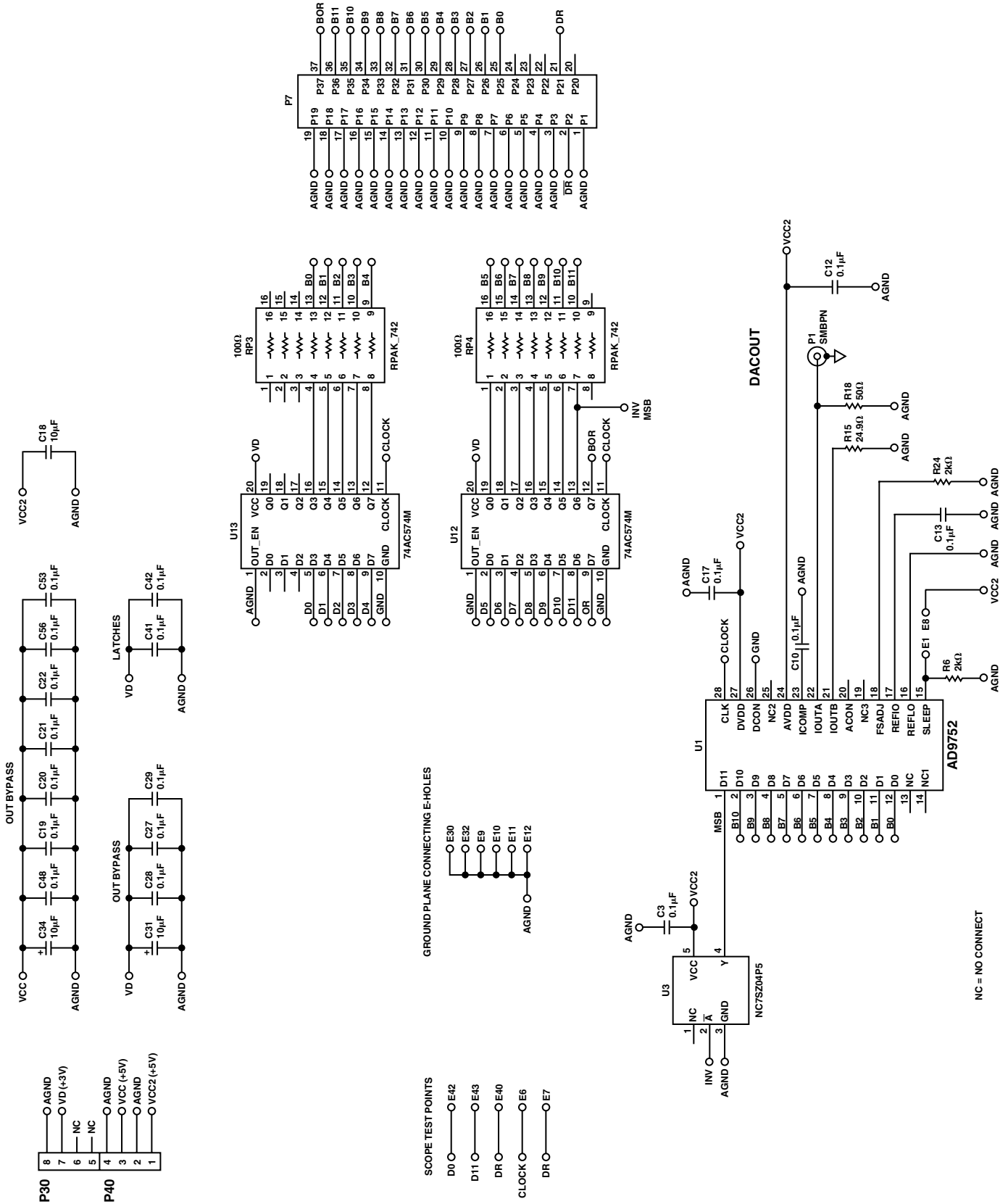



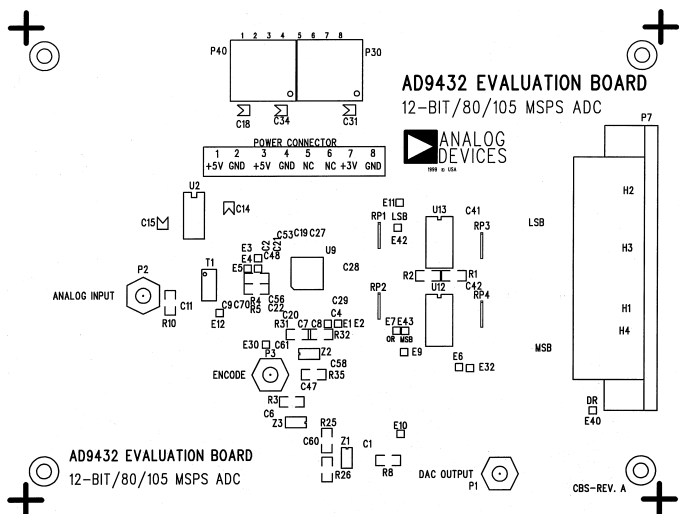

Figure 18. Top Silkscreen

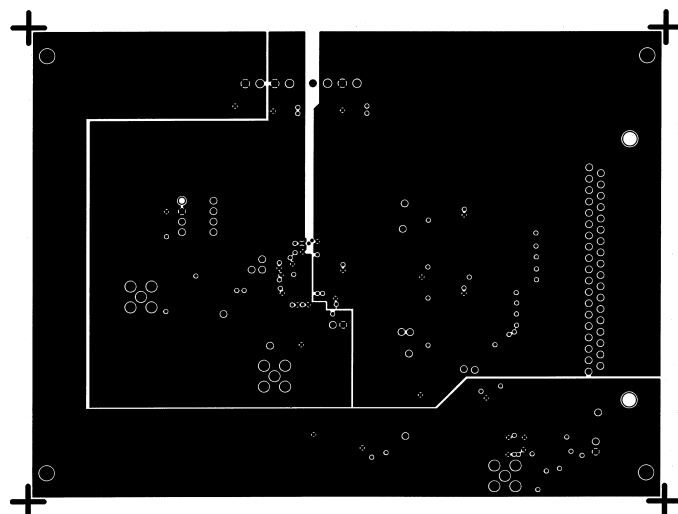

Figure 21. Split Power Plane

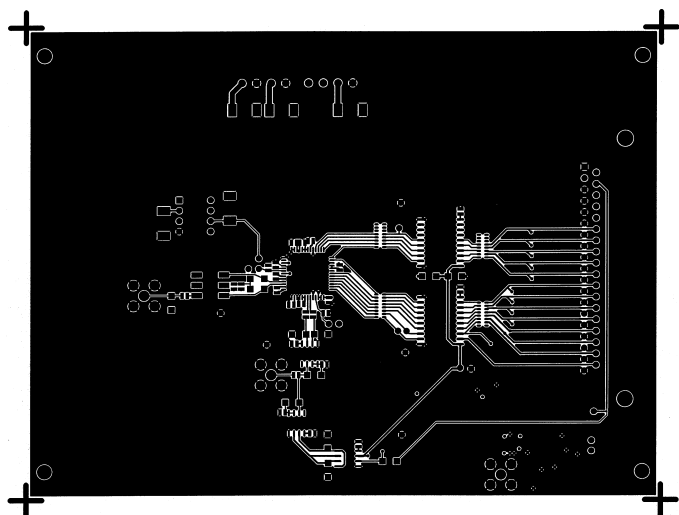

Figure 19. Top Level Routing

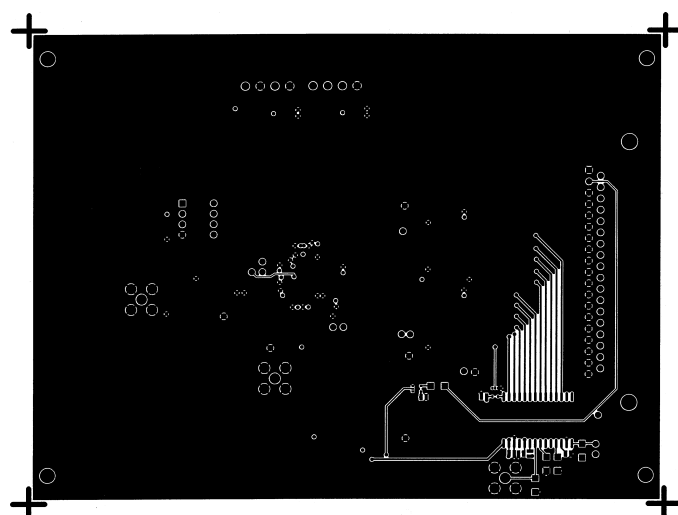

Figure 22. Bottom Layer Route

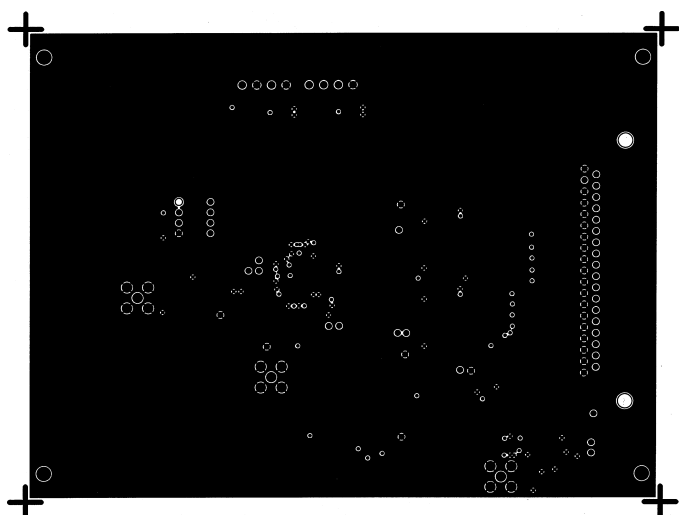

Figure 20. Ground Plane



Figure 23. Bottom Silkscreen



## Revision History

<b>Location</b>	<b>Page</b>
<b>Data Sheet changed from REV. D to REV. E.</b>	
Edits to SPECIFICATIONS .....	3
Edits to ABSOLUTE MAXIMUM RATINGS .....	3
Edits to ORDERING GUIDE .....	3
Addition of text to USING THE AD9432 section .....	9
Edits to Figure 17a .....	13
Edits to Figure 17b .....	14
Addition of SQ-52 Package Outline .....	16

