

ADC0851 and ADC0858 8-Bit Analog Data Acquisition and Monitoring Systems

General Description

The ADC0851 and ADC0858 are 2 and 8 input analog data acquisition systems. They can function as conventional multiple input A/D converters, automatic scanning A/D converters or programmable analog "watchdog" systems. In "watchdog" mode they monitor analog inputs and determine whether these inputs are inside or outside user programmed window limits. This monitoring process takes place independent of the host processor. When any input falls outside of its programmed window limits, an interrupt is automatically generated which flags the processor; the chip can then be interrogated as to exactly which channels crossed which limits.

The advantage of this approach is that it frees the processor from having to frequently monitor analog variables. It can consequently save having to insert many A/D subroutine calls throughout real time application code. In control systems where many variables are continually being monitored this can significantly free up the processor, especially if the variables are DC or slow varying signals.

The Auto A/D conversion feature allows the device to scan through selected input channels, performing an A/D conversion on each channel without the need to select a new channel after each conversion.

Key Specifications

■ Resolution	8 Bits
■ Total error	$\pm 1/2$ LSB or ± 1 LSB
■ Low power	50 mW
■ Conversion time	18 μ s/Channel
■ Limit comparison time	2 μ s/Limit

Features

- Watchdog operation signals processor when any channel is outside user programmed window limits
- Frees microprocessor from continually monitoring analog signals and simplifies applications software
- 2 (ADC0851) or 8 (ADC0858) analog input channels
- Single ended or differential input pairs
- COM input for DC offsetting of input voltage
- 4 (ADC0851) and 16 (ADC0858), 8-bit programmable limits
- NSC MICROWIRE™ interface
- Power fail detection
- Auto A/D conversion feature
- Single 5V supply
- Window limits are user programmable via serial interface

Applications

- Instrumentation monitoring and process control
- Digitizing automotive sensor signals
- Embedded diagnostics

Simplified Block Diagram

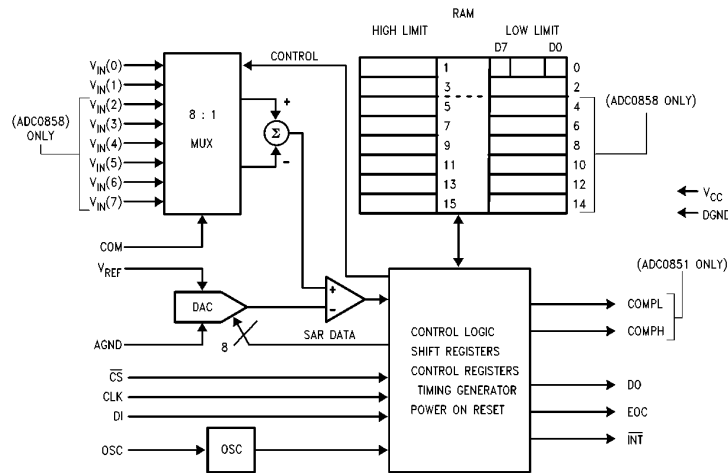
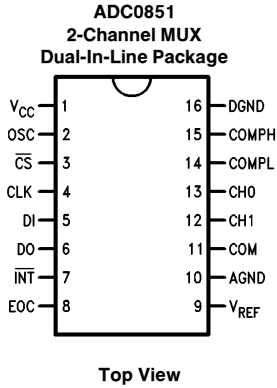

FIGURE 1

TL/H/11021-22

TRI-STATE® is a registered trademark of National Semiconductor Corporation.
MICROWIRE™ is a trademark of National Semiconductor Corporation.

Connection Diagrams



TL/H/11021-1

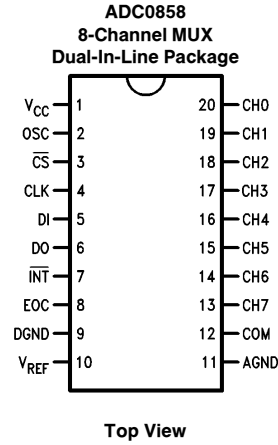

TL/H/11021-2

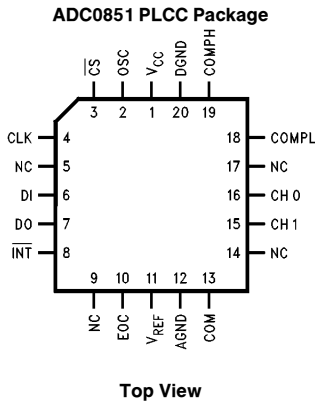

TL/H/11021-3

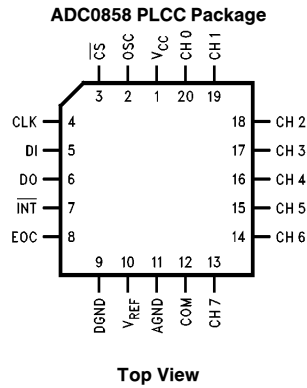

TL/H/11021-4

Ordering Information

Industrial ($-40^{\circ}\text{C} \leq T_A \leq +85^{\circ}\text{C}$)	Package
ADC0851BIN, ADC0851CIN	N16E, 16-Pin Plastic DIP
ADC0858BIN, ADC0858CIN	N20A, 20-Pin Plastic DIP
ADC0851BIV, ADC0851CIV	V20A, 20-Lead PLCC
ADC0858BIV, ADC0858CIV	V20A, 20-Lead PLCC

Military ($-55^{\circ}\text{C} \leq T_A \leq +125^{\circ}\text{C}$)	Package
ADC0851CMJ/883	J16A, 16-Pin Ceramic DIP
ADC0858CMJ/883	J20A, 20-Pin Ceramic DIP

Absolute Maximum Ratings (Notes 1 & 2)

If Military/Aerospace specified devices are required, please contact the National Semiconductor Sales Office/Distributors for availability and specifications.

Supply Voltage, V_{CC}	6.5V
Voltage at Logic and Analog Inputs (Note 3)	-0.3V to $V_{CC} + 0.3V$
Input Current per Pin	± 5 mA
Input Current per Package	± 20 mA
Storage Temperature	-65°C to +150°C
Package Dissipation at $T_A = +25^\circ\text{C}$ (Board Mount)	500 mW 800 mW
Lead Temperature (Soldering, 10 Sec.)	
Dual-In-Line (Plastic)	+260°C
Dual-In-Line (Ceramic)	+300°C
ESD Susceptibility (Note 4)	2000V

Operating Ratings (Notes 1 & 2)

Supply Voltage, V_{CC}	4.5V to 5.5V
Temperature Range	$T_{MIN} \leq T_A \leq T_{MAX}$
ADC0858CMJ/883	-55°C $\leq T_A \leq$ +125°C
ADC0851CMJ/883	-55°C $\leq T_A \leq$ +125°C
ADC0858BIN, ADC0858CIN	-40°C $\leq T_A \leq$ +85°C
ADC0851BIN, ADC0851CIN	-40°C $\leq T_A \leq$ +85°C
ADC0858BIV, ADC0858CIV	-40°C $\leq T_A \leq$ +85°C
ADC0851BIV, ADC0851CIV	-40°C $\leq T_A \leq$ +85°C

DC Electrical Characteristics

The following specifications apply for $V_{CC} = +5$ V_{DC}, $V_{REF} = +4.5$ V_{DC}, AGND = DGND = 0V and $f_{OSC} = 1$ MHz ($R_{ext} = 3.16$ k Ω , $C_{ext} = 170$ pF) unless otherwise specified. **Boldface limits apply for $T_A = T_J = T_{MIN}$ to T_{MAX}** ; all other limits apply at $T_A = T_J = +25^\circ\text{C}$.

Parameter	Conditions	Typical (Note 5)	Limit (Note 6)	Units (Limits)
CONVERTER AND MULTIPLEXER CHARACTERISTICS				
Total Unadjusted Error (Note 7) ADC0851/8/BIN, ADC0851/8/BIV ADC0851/8/CIN, ADC0851/8/CMJ, ADC0851/8/CIV			$\pm \frac{1}{2}$ ± 1 ± 1	LSB (Max) LSB (Max) LSB (Max)
Comparator Offset ADC0851/8/BIN, ADC0858BIV ADC0851/8/CIN, ADC0851/8/CMJ, ADC0858CIV		± 2.5 ± 2.5 ± 2.5	± 10 ± 20 ± 20	mV (Max) mV (Max) mV (Max)
V_{REF} Input Resistance		6	3.5 10	k Ω (Min) k Ω (Max)
Common Mode Input Voltage (Note 8)	All MUX Inputs and COM Input		GND - 0.05 $V_{CC} + 0.05$	V (Min) V (Max)
DC Common Mode Error	$\Delta V_{CM} = -0.05V$ to $+5.05V$	$\pm 1/16$	$\pm 1/4$	LSB (Max)
Power Supply Sensitivity	$V_{REF} = 4.75V$ $V_{CC} = 5V \pm 5\%$ $V_{REF} = 4.5V$ $V_{CC} = 5V \pm 10\%$	$\pm 1/16$ $\pm 1/16$	$\pm 1/4$ $\pm 1/2$	LSB (Max)
I_{OFF} , Off Channel Leakage Current (Note 9)	On Channel = 5V Off Channel = 0V	-0.01	-3	μA (Max)
	On Channel = 0V Off Channel = 5V	+0.01	+3	μA (Max)
I_{ON} , On Channel Leakage Current (Note 9)	On Channel = 5V Off Channel = 0V	+0.01	+3	μA (Max)
	On Channel = 0V Off Channel = 5V	-0.01	-3	μA (Max)

DC Electrical Characteristics (Continued)

The following specifications apply for $V_{CC} = +5 V_{DC}$, $V_{REF} = +4.5 V_{DC}$, $AGND = DGND = 0V$ and $f_{OSC} = 1 \text{ MHz}$ ($R_{ext} = 3.16 \text{ k}\Omega$, $C_{ext} = 170 \text{ pF}$) unless otherwise specified. **Boldface limits apply for $T_A = T_J = T_{MIN}$ to T_{MAX}** ; all other limits apply at $T_A = T_J = +25^\circ\text{C}$.

Parameter	Conditions	Typical (Note 5)	Limit (Note 6)	Units (Limits)
DIGITAL CHARACTERISTICS				
Logic "1" Input Voltage, V_{IH}	$V_{CC} = 5.5V$		2.2	V (Min)
Logic "0" Input Voltage, V_{IL}	$V_{CC} = 4.5V$		0.8	V(Max)
Logic "1" Input Current, I_{IH}	$V_{IN} = V_{CC}$	0.005	3	μA (Max)
Logic "0" Input Current, I_{IL}	$V_{IN} = 0V$	-0.005	-3	μA (Max)
Logic "1" Output Voltage, V_{OH} (Except \overline{INT})	$V_{CC} = 4.5V$ $I_{OUT} = -360 \mu\text{A}$ $I_{OUT} = -10 \mu\text{A}$		2.4 4.2	V (Min) V (Min)
Logic "0" Output Voltage, V_{OL}	$I_{OUT} = 1.6 \text{ mA}$ $V_{CC} = 4.5V$		0.4	V (Max)
TRI-STATE® Output Current (DO)	$\overline{CS} = \text{Logic "1" (5V)}$ $V_{OUT} = 0.4V$ $V_{OUT} = 5V$	-0.1 0.1	-3 3	μA (Max) μA (Max)
I_{SOURCE} (Except \overline{INT})	V_{OUT} Short to GND	-14	-6.5	mA (Min)
I_{SINK}	V_{OUT} Short to V_{CC}	16	8	mA (Min)
Supply Current, I_{CC} ADC0851 or ADC0858	$f_{CLK} = 1 \text{ MHz}$ $f_{CLK} = 2 \text{ MHz}$ (Note 10)	7 7.2	10	mA (Max) mA

AC Electrical Characteristics

The following specifications apply for $V_{CC} = +5 V_{DC}$, $V_{REF} = +4.5 V_{DC}$, $AGND = DGND = 0V$, $f_{CLK} = 1 \text{ MHz}$, $t_r = t_f = 5 \text{ ns}$ unless otherwise specified. **Boldface limits apply for $T_A = T_J = T_{MIN}$ to T_{MAX}** ; all other limits apply at $T_A = T_J = 25^\circ\text{C}$.

Symbol	Parameter	Conditions	Typical (Note 5)	Limit (Note 6)	Units (Limits)
f_{CLK}	Data Clock Frequency		1	2	MHz (Max)
	Clock Duty Cycle (Note 11)			40 60	% (Min) % (Max)
t_{SET-UP}	\overline{CS} Falling Edge or Data Input Valid to CLK Rising Edge		30	70	ns (Min)
t_{HOLD}	Data Input Valid after CLK Rising Edge		5	30	ns (Min)
t_{PD1} , t_{PD0}	CLK Rising Edge to Output Data Valid	$C_L = 100 \text{ pF}$	80	200	ns (Max)

AC Electrical Characteristics (Continued)

The following specifications apply for $V_{CC} = +5 V_{DC}$, $V_{REF} = +4.5 V_{DC}$, $AGND = DGND = 0V$, $f_{CLK} = 1 \text{ MHz}$, $t_r = t_f = 5 \text{ ns}$ unless otherwise specified. **Boldface limits apply for $T_A = T_J = T_{MIN}$ to T_{MAX}** ; all other limits apply at $T_A = T_J = 25^\circ\text{C}$.

Symbol	Parameter	Conditions	Typical (Note 5)	Limit (Note 6)	Units (Limits)
t_{1H}, t_{0H}	Rising Edge of \overline{CS} to Data Output Hi-Z	$C = 100 \text{ pF}$, $R = 2k$ (See TRI-STATE Test Circuits)	90	200	ns (Max)
f_{OSC}	Oscillator Clock Freq. (Analog Timing)	$R_{ext} = 3.16 \text{ k}\Omega$ $C_{ext} = 170 \text{ pF}$	1	1.4 0.6	MHz (Max) MHz (Min)
t_{EOC}	\overline{CS} to End of Conversion Delay			1 2	OSC Clock Periods Min Max
t_{Conv}	Conversion Time			17 18	OSC Clock Periods (Min) (Max)
$t_{\overline{CS-INT}}$	\overline{CS} to Interrupt Delay		60	120	ns (Max)
C_{IN}	Capacitance of Logic Input		5		pF
C_{OUT}	Capacitance of Logic Output		5		pF

Note 1: Absolute Maximum Ratings indicate limits beyond which damage to the device may occur. Operating Ratings indicate conditions for which the device is functional, but do not guarantee specific performance limits. For guaranteed specifications and test conditions, see the Electrical Characteristics. The guaranteed specifications apply only for the test conditions listed. Some performance characteristics may degrade when the device is not operated under the listed test conditions.

Note 2: All voltages are measured with respect to ground ($AGND = DGND = 0V$).

Note 3: All of the analog and digital input pins are internally diode clamped to the supply pins. Should the applied voltage at any pin exceed the power supply voltage, the additional absolute value of current at that pin (caused by the forward biasing of the internal diodes) should be limited to 5 mA or less.

Note 4: Human body model, 100 pF discharged through a 1.5 k Ω resistor.

Note 5: Typical specifications are at $+25^\circ\text{C}$ and represent the most likely parametric norm.

Note 6: Tested limits are guaranteed to National's AOQL (Average Outgoing Quality Level).

Note 7: Total unadjusted error includes comparator offset, ADC linearity and multiplexer error, and, is expressed in LSBs.

Note 8: Two on-chip diodes are tied to each analog input. The diodes will forward conduct for analog input voltages one diode drop below ground or one diode drop above V_{CC} . Care should be exercised when operating the device at low supply voltages (e.g., $V_{CC} = 4.5V$) because high analog inputs (5V) can cause the input diodes to conduct, especially at elevated temperatures. This will cause errors for analog inputs near full scale. The specification allows 50 mV forward bias of either clamp diode. Thus as long as V_{IN} or V_{REF} does not exceed the supply voltage by more than 50 mV, the output code will be correct. To achieve an absolute 0 V_{DC} to 5 V_{DC} input voltage range will therefore require a minimum supply voltage of 4.950 V_{DC} .

Note 9: Leakage current is measured with the oscillator clock disabled.

Note 10: Measured supply current does not include the DAC ladder current.

Note 11: A 40% to 60% clock duty cycle range ensures proper operation at all clock frequencies.

Typical Performance Characteristics

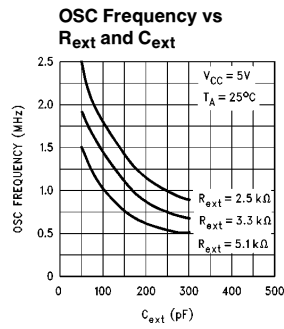
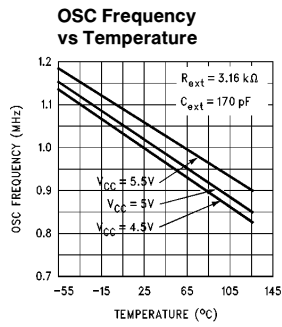
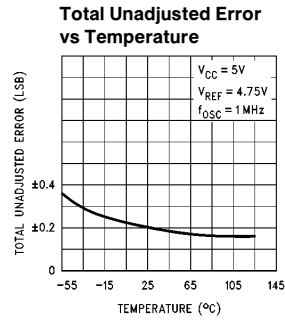
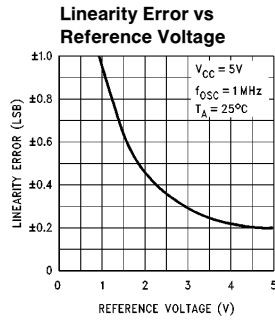
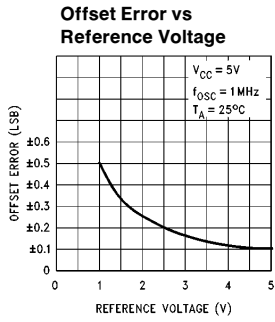

TL/H/11021-5

Test Circuits and Waveforms

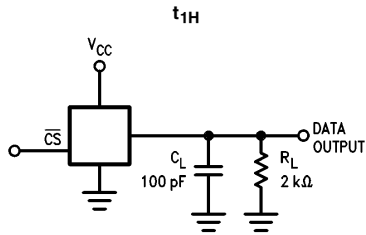

TL/H/11021-6

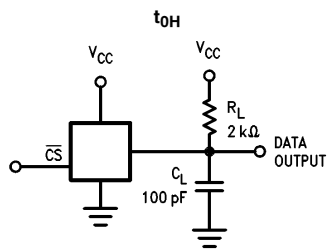
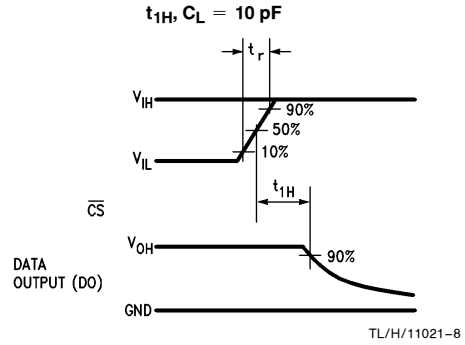

TL/H/11021-7

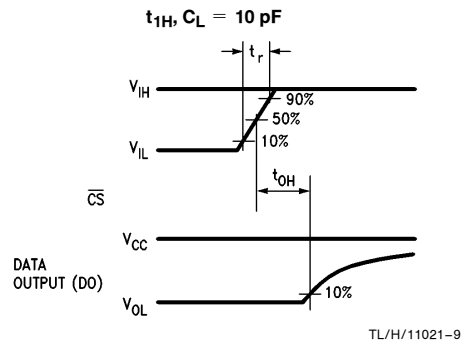

Timing Diagrams

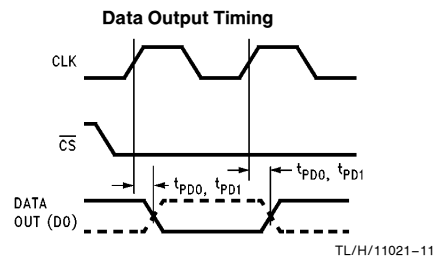
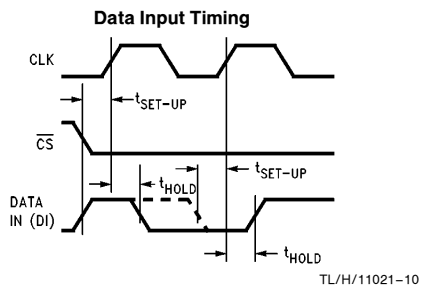

Timing Diagrams (Continued)

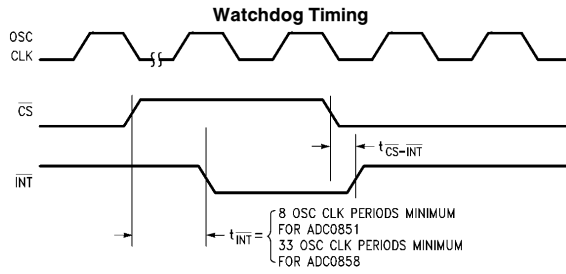

TL/H/11021-12

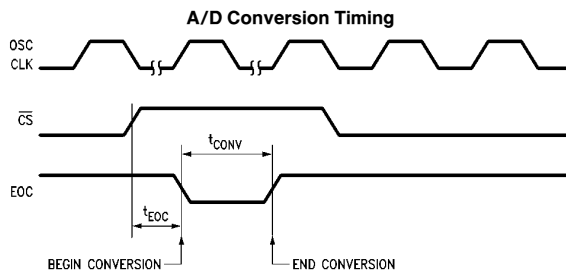

TL/H/11021-13

Timing Diagrams for ADC0851 and ADC0858

Read Power Flag after Power Up ADC0851/ADC0858

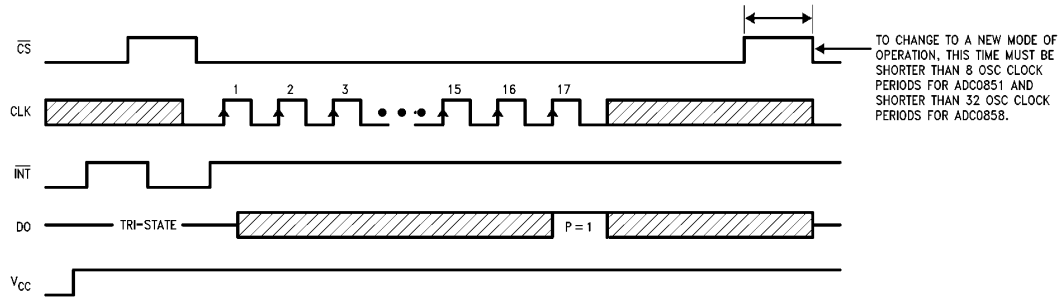

TL/H/11021-14

Timing Diagrams for ADC0851 and ADC0858 (Continued)

Watchdog Operation ADC0851

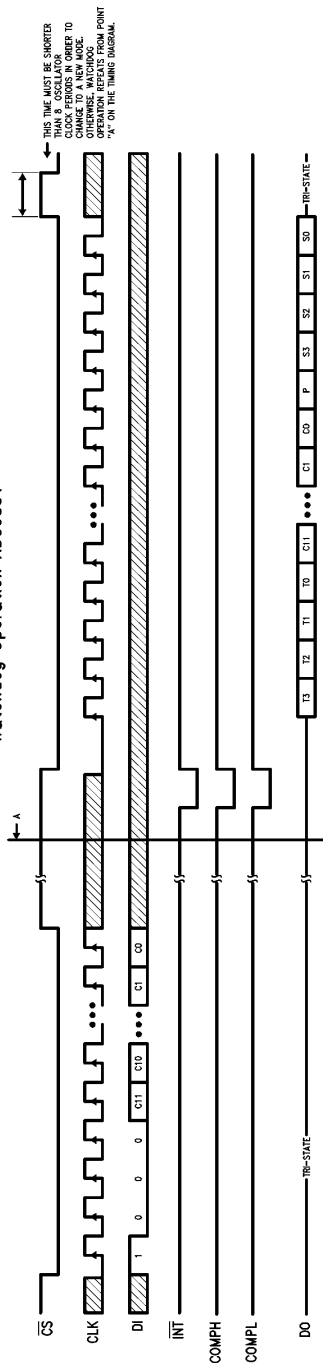

Watchdog Operation ADC0858

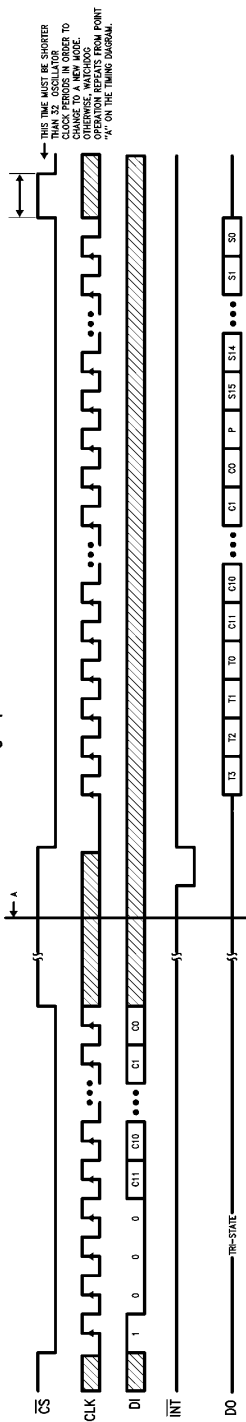

Write 1 Limit to ADC0851/ADC0858

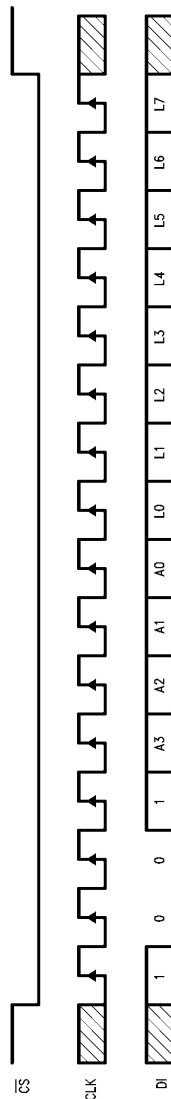

TL/H/11021-15

TL/H/11021-16

Timing Diagrams for ADC0851 and ADC0858 (Continued)

Write all Limits to ADC0851/ADC0858

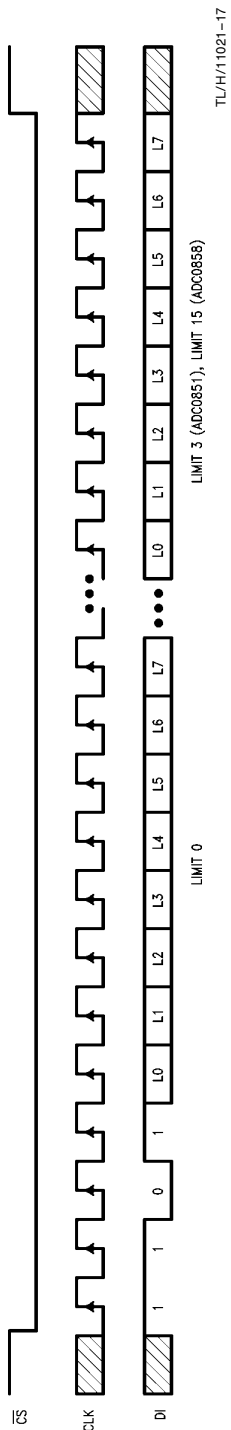

Read 1 Limit from ADC0851/ADC0858

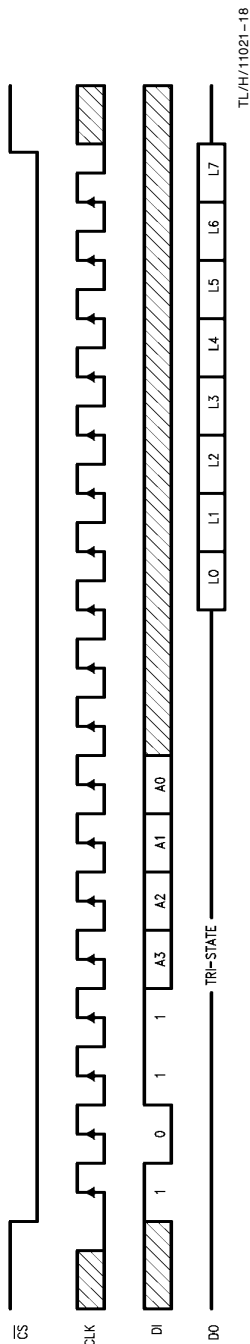

Read all Limits from ADC0851/ADC0858

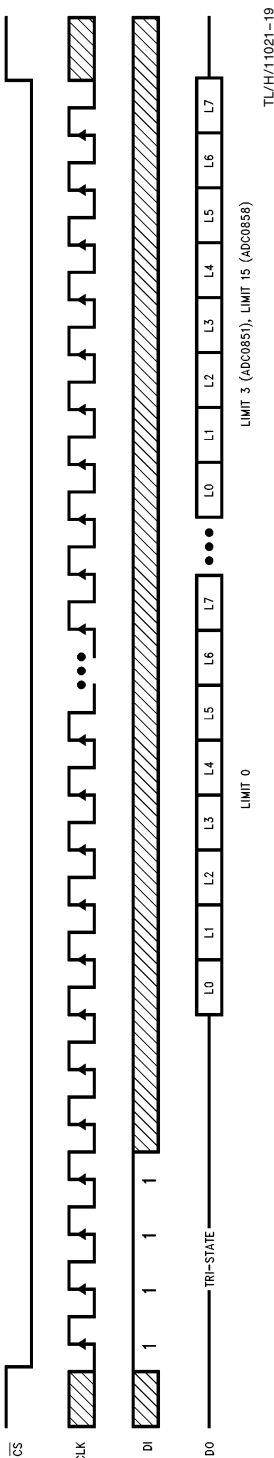

Timing Diagrams for ADC0851 and ADC0858 (Continued)

1 A/D Conversion ADC0851/ADC0858

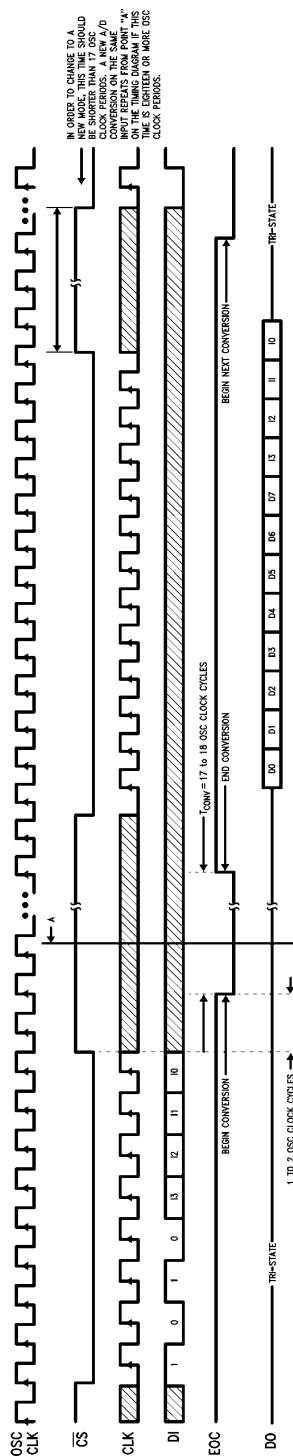

TL/H/11021-20

Auto A/D Conversion ADC0851/ADC0858

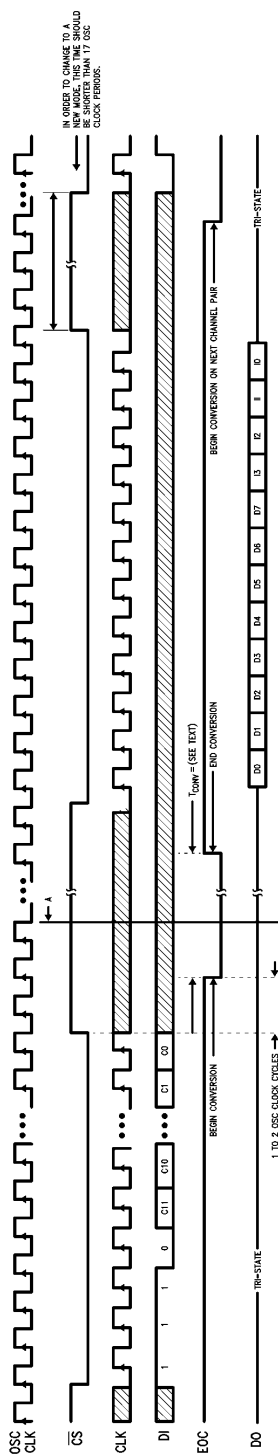

TL/H/11021-21

ADC0851 Programming Chart

Function	Receive (DI)		Transmit (DO)	Comments
	Mode			
Watchdog	1000	C11 ... C0	T3 ... T0, C11 ... C0, P, S3 ... S0	Send Data after \overline{INT}
Write 1 Limit	1001	A3 ... A0, L0 ... L7		Write Limit to RAM
1 A/D Conversion	1010	I3 ... I0	D0 ... D7, I3 ... I0	Send Data after Conversion
Read 1 Limit	1011	A3 ... A0	L0 ... L7	Send Limit from RAM
Test	1100			Do Not Use (See Text)
Write all Limits	1101	4 Bytes, L0 First		Write All Limits to RAM
Auto A/D Convert	1110	C11 ... C0	D0 ... D7, I3 ... I0	Continuous Conversion
Read all Limits	1111		4 Bytes, L0 First	Send all Limits from RAM

ADC0858 Programming Chart

Function	Receive (DI)		Transmit (DO)	Comments
	Mode			
Watchdog	1000	C11 ... C0	T3 ... T0, C11 ... C0, P, S15 ... S0	Send Data after \overline{INT}
Write 1 Limit	1001	A3 ... A0, L0 ... L7		Write Limit to RAM
1 A/D Conversion	1010	I3 ... I0	D0 ... D7, I3 ... I0	Send Data after Conversion
Read 1 Limit	1011	A3 ... A0	L0 ... L7	Send Limit from RAM
Test	1100			Do Not Use (See Text)
Write all Limits	1101	16 Bytes, L0 First		Write all Limits to RAM
Auto A/D Convert	1110	C11 ... C0	D0 ... D7, I3 ... I0	Continuous Conversion
Read all Limits	1111		16 Bytes, L0 First	Send all Limits from RAM

Serial Communication Bit Order

Information Type	Bit Order					
	ADC0851			ADC0858		
	First		Last	First		Last
Limit Data	L0	...	L7	L0	...	L7
A/D Conversion Data	D0	...	D7	D0	...	D7
Limit Address	A3	...	A0	A3	...	A0
Status	S3	...	S0	S15	...	S0
Channel Tag	T3	...	T0	T3	...	T0
Channel Configuration	C11	...	C0	C11	...	C0
Channel Information	I3	...	I0	I3	...	I0
Mode	M3	...	M0	M3	...	M0
Power Fail	P (One Bit)			P (One Bit)		

Pin Descriptions

V _{CC}	Positive power supply pin. Bypass to analog ground with a 0.1 μ F ceramic capacitor in parallel with a 10 μ F tantalum capacitor.	AGND	Analog ground reference.
OSC	Input/Output pin used to generate internal timing for A/D conversion. This pin is connected to an external resistor and capacitor to set the oscillation frequency for analog timing (see <i>Figure 12</i>).	DGND	Digital ground reference for the logic inputs. Both AGND and DGND should be at same potential.
$\overline{\text{CS}}$	This is the chip select input pin. It must be held low while data is transferred to or from the ADC0851/8 (see Timing Diagram).	V _{REF}	This is the analog reference pin. The voltage applied to this pin sets the full scale A/D conversion range. Recommended voltages applied to this pin range from 1V to V _{CC} . Bypass to analog ground with a 0.1 μ F ceramic capacitor in parallel with a 10 μ F tantalum capacitor.
CLK	The serial clock input pin is used to clock serial data either into the data input pin (DI) or out of the data output pin (DO). Input data is loaded on the rising edge of CLK and the output data is valid at the falling edge of CLK.	COM	The COM pin functions as an inverting differential input common to all analog inputs when each channel is configured as a single-ended channel. If the input channels are programmed as differential pairs then the COM input has no effect.
DI	Serial data digital input pin.	CH0–CH1 (ADC0851)	CH0–CH7 are analog input channels which can be configured as single ended inputs or as differential pairs. The analog input voltage should stay within the power supply range.
DO	TRI-STATE data output pin.	CH0–CH7 (ADC0858)	
$\overline{\text{INT}}$	This is the active low interrupt pin that indicates that at least one analog input channel voltage level has exceeded the programmed window limits. Since this pin has an open drain output, an external pull up resistor is required. This allows many devices to be wire-ORed together using a single pull-up resistor.	COMPL, COMPH	These output pins are available only on the ADC0851. During “Watchdog” operation, if either of the inputs exceeds the window limits, not only is an interrupt generated but also the COMPL and COMPH pins go low to indicate whether the upper or lower boundary was exceeded (See applications section for more information.)
EOC	End of conversion output pin. The low state indicates that an A/D conversion is in progress. The EOC pin goes high when the conversion is completed.		

General Overview

The ADC0851/58 is a versatile microprocessor-compatible data acquisition system with an on-board watchdog capability. The device is capable of synchronous serial interface with most microprocessors and includes a multiplexer, a RAM and a successive approximation register. The ADC0851 and the ADC0858 have two and eight input channels respectively.

1.0 Modes of Operation

The device can be used in any one of the eight modes of operation listed below. A mode is selected by taking \overline{CS} low and providing the IC with an input word whose first four bits specify the desired mode (see the "Programming Charts" for the mode selection codes):

1.1 WATCHDOG MODE

This mode of operation allows the device to operate as a digitally-programmable window comparator. The analog input voltage at each channel is compared against the upper and lower boundary limits stored in an internal RAM. When an input falls outside of its programmed window limits, an interrupt is generated. The microprocessor can then pull \overline{CS} low which causes the device to produce a bit stream that indicates which channel(s) crossed which limit(s).

The watchdog mode is selected by taking \overline{CS} low and shifting in the four bit word (1 0 0 0) followed by a twelve bit word that configures the analog inputs to operate either as single-ended or as differential pairs (CH0-CH1, CH2-CH3, etc.). When a channel is operating single-ended, its input voltage is compared to the upper and lower limits stored in RAM for that input. When two inputs are configured as a differential pair, the limits stored in the RAM for the channel with the lower number will be compared against the differential input voltage. For example, the differential voltage CH0-CH1 will be compared with the lower and upper limits for CH0. The limits are programmed using the "write one limit to RAM" or "write all limits to RAM" mode.

Data Input (DI) Word—ADC0851 or ADC0858

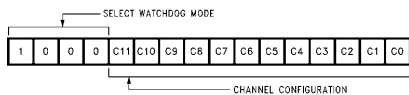

TL/H/11021-23

1.2 WRITE ONE LIMIT TO RAM

This mode allows the user to update a single limit for one of the input channels. This is accomplished by using a 16-bit stream of input data (see "Programming Chart"). The first four bits (1 0 0 1) select the mode, the next four bits select

the input channel and the limit (upper or lower) that will be preset, and the last eight bits set the limit (or comparator threshold).

The limit data representing the input voltage limit (or comparator threshold) is expressed as per the following equation:

$$V_{LIM} = V_{REF} (1/2 L7 + 1/4 L6 + \dots + 1/256 L0)$$

where L7 is the MSB.

Data Input (DI) Word—ADC0851 or ADC0858

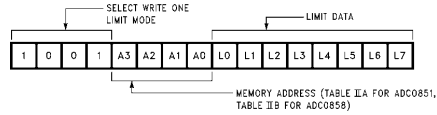

TL/H/11021-24

1.3 WRITE ALL LIMITS TO RAM

This mode is used to update each pair of lower and upper limits for all channels. This is accomplished by a stream of input data whose first four bits select the mode of operation followed by four bytes of limit data for the ADC0851 and sixteen bytes of limit data for the ADC0858.

The limit data representing the input voltage limit (or comparator threshold) is expressed as per the following equation:

$$V_{LIM} = V_{REF} (1/2 L7 + 1/4 L6 + \dots + 1/256 L0)$$

where L7 is the MSB.

Data Input (DI) Word—ADC0851 or ADC0858

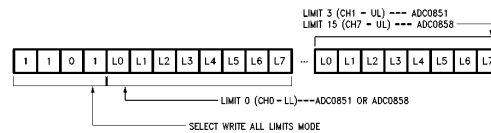

TL/H/11021-25

1.4 READ ONE LIMIT FROM RAM

When the ADC0851/8 is configured in this mode, the user can read back an 8-bit limit word from the RAM memory location pointed to by the limit address. An 8-bit input word selects the mode (1 0 1 1) and the memory location to be read.

Data Input (DI)—ADC0851 or ADC0858

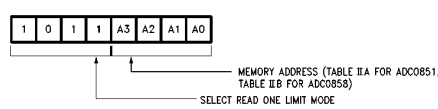

TL/H/11021-26

1.0 Modes of Operation (Continued)

1.5 READ ALL LIMITS FROM RAM

This mode of operation allows the device to serially output 8-bit limit data from each memory location in succession starting with CH0-lower limit (see Section 2.4 under interface considerations).

Data Input (DI) Word—ADC0851 or ADC0858

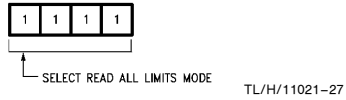

1.6 INITIATE ONE A/D CONVERSION

At any time, the user can initiate an A/D conversion on any input channel. Note that the input channels may be configured as single ended or differential inputs. The first four bits of the input word select the mode of operation and the next four bits assign the multiplexer configuration.

Data Input (DI) Word—ADC0851 or ADC0858

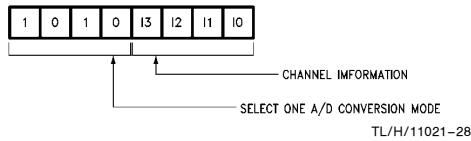

1.7 INITIATE AUTO A/D CONVERSION

When configured in this mode, an A/D conversion is done on a channel or channel pair and after the output data is transmitted, conversion begins on the next subsequent channel or channel pair. In this mode the device continually scans through the input channels making A/D conversions unless the device's mode of operation is changed. The first four bits of the input word select the mode of operation and the next twelve bits assign the multiplexer configuration.

Data Input (DI) Word—ADC0851 or ADC0858

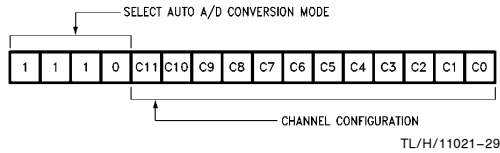

1.8 TEST MODE

This mode is used to test the ADC0851/8 at the factory and is **not** intended for normal use. If this mode is accidentally selected, the supply voltage must be disconnected and then reconnected to reset the device.

2.0 Conversion Timing vs Serial Interface Timing

Note that the ADC0851/8 uses two clock signals for proper operation. Connecting an external resistor (R_{ext}) from the OSC pin (pin 2) to V_{CC} and an external capacitor (C_{ext}) from

the OSC pin to ground causes the device's internal oscillator to generate the OSC clock signal for A/D conversion and watchdog timing. With $R_{ext} = 3.16 \text{ k}\Omega$ and $C_{ext} = 170 \text{ pF}$, the OSC clock frequency is approximately 1 MHz. Note that internally, ADC0851/8 divides the OSC clock frequency by two. An A/D conversion is completed in eighteen OSC clock periods maximum. It should be noted that the OSC pin of the ADC0851/8 should not be driven by an external clock.

An external clock signal is applied to the CLK pin (pin 4) of the ADC0851/8. The CLK signal is used to clock serial data either into the data input pin (DI) or out of the data output pin (DO).

Note that input data is loaded at the rising edge of CLK while the output data is valid at the falling edge of CLK. All digital timing such as data set-up and hold times and delays are measured with respect to the CLK signal. The OSC clock and CLK frequencies need not be the same.

3.0 Programming Information

The ADC0851 and ADC0858 communicate data serially over the DI (data input) and DO (data output) lines. The data format for the input and output words for various modes of operation are shown in the "programming charts."

There are nine types of data as shown in the "serial communication bit order" table. The order in which data is communicated is MSB first in all but two cases: Limit data and A/D conversion data. The various data types are described below.

3.1 LIMIT DATA (L0, L1, . . . L7)

Limits on the ADC0851/8 are 8 bits in width and can either represent an upper or lower boundary limit. Limit data can either be written (in the "write one limit" or "write all limits" mode) to or read (in the "read one limit" or "read all limits" mode) from the limit RAM. Being able to read back the limit data allows system testability, and it also allows independent software routines to see what window limits were previously written to the chip. During watchdog operation, a programmed limit must be crossed in order to cause an interrupt.

3.2 A/D CONVERSION DATA (D0, D1, . . . D7)

There are two A/D conversion modes (One A/D conversion and Auto A/D conversion) that produce 8-bit conversion data. During either type of A/D conversion, a single-ended analog input or a differential analog input pair is digitized to produce this conversion data.

3.3 LIMIT ADDRESS (A3, A2, . . . A0)

The limit address points to the location, within the limit RAM, to which limit data is sent or from which it is received. Limit address is used in the "write one limit to RAM", "write all limits to RAM", "read one limit from RAM" or "read all limits from RAM" mode. There are two addresses for each analog input; the even addresses correspond to the lower

3.0 Programming Information

(Continued)

limits while the odd addresses correspond to the upper limits. The ADC0851 and ADC0858 both use four bits (A3–A0) to address the limit RAM but the ADC0851 only decodes the two LSBs while ignoring the two MSBs. The ADC0858 decodes all four bits thus yielding sixteen limit addresses.

3.4 STATUS AND CHANNEL TAG DATA (S3, S2, . . . , S0, ADC0851; S15, S14, . . . , S0, ADC0858) (T3, T2, . . . , T0)

During watchdog mode, immediately after one analog input is determined to be outside of its programmed window limit, its channel number is stored in the channel tag register and the remaining inputs are checked one more time and the pass/fail status of each input is stored in the status register. When the microprocessor receives the interrupt signal, it can read the status and channel tag data by pulling \overline{CS} low and clocking out the data.

3.5 CHANNEL CONFIGURATION DATA (C11, C10, . . . C0)

The channel configuration data assigns the configuration of the multiplexer. The data is comprised of twelve bits with each group of three bits addressing an analog input channel pair. Each channel pair can be configured for single-ended operation, differential operation, one single ended channel and one disabled channel, or both channels disabled. The channel configuration data is required when the device is in the watchdog or Auto A/D conversion mode.

3.6 CHANNEL INFORMATION DATA (I3, I2, . . . I0)

This data is used by the ADC0851/8 only when the device is configured in the “One A/D conversion” mode. The channel information data assigns the configuration of the multiplexer.

3.7 MODE ADDRESS (M3, M2, . . . M0)

The input word (DI) configures the ADC0851/8 for various modes of operation. The first four bits of the input word constitute the mode address which specifies the mode of operation.

3.8 POWER FAIL BIT (P)

The ADC0851/8 is automatically configured to the watchdog mode upon power-up and an interrupt is immediately generated after \overline{CS} is pulled high. Pulling \overline{CS} low produces a 17-bit data stream. The seventeenth bit of the output word DO in the watchdog mode is the power fail bit, P. If the output data is read after power-up then P will be at logical “1”. Changing the mode of operation resets P to logical “0”. Any subsequent power failure will cause the device to configure in the watchdog mode upon power-up with P at logical “1”.

4.0 Initialization after Power-Up

The ADC0851/8 is automatically configured in the watchdog mode upon power-up. After reading the power fail bit \overline{CS} is pulled high. To exit the watchdog mode and to change to a new mode of operation, \overline{CS} should be high less than eight oscillator clock periods for the ADC0851 and less than

thirty two oscillator clock periods for the ADC0858 respectively (see the Timing Diagram, “Read Power Flag after Power Up ADC0851/8”). When changing to a new mode of operation, the device readies itself to read a new input word clocked in at the data input (DI) pin. The input word configures the new mode of operation.

Functional Description

The simplified block diagram (Figure 1, front page) shows the various functional blocks. The ADC0851 and ADC0858 include 2- and 8-channel analog input multiplexers respectively. Using the appropriate serial input word at the Data Input (DI) pin, the analog channels can be configured for either single-ended operation or differential mode operation. The COM input pin provides additional flexibility since the COM pin functions as an inverting differential input common to all analog inputs when each channel is configured as a single ended channel. Applying an external DC voltage at the COM pin allows offsetting the single ended analog input voltages from ground (pseudo-differential mode). Input channels that are configured as differential pairs will be unaffected by the voltage at COM pin.

The ADC0851/8 includes an 8-bit DAC, a comparator and an 8-bit successive approximation register. An analog-to-digital conversion can be initiated at any time on any one of the input channels. The 8-bit digital word corresponding to the analog input voltage is serially clocked out at the Data Output (DO) pin. In addition to its use as a multiplexed A/D converter, the ADC0851/8 may also be used as a window comparator in the watchdog mode. An upper and lower boundary limit corresponding to each analog input voltage may be stored in an internal RAM. The RAM consists of sixteen memory locations, each 8 bit wide; however, for the ADC0851 only four memory locations are used. Limit data can either be written into or read back from the RAM. The read/write capability allows independent software routines to read back previously programmed window limits. Furthermore, currently programmed limits may also be read back to ensure system testability. An address register holds the addresses of the RAM's memory locations where data may either be stored or retrieved from.

When the device is operated in the watchdog mode (as described in the “general overview” section), the analog inputs are continually polled and compared against their respective window limits. Once an input signal that has exceeded either boundary limit is detected, a “1” is stored in the MSB position in a 16-bit status register, indicating a limit crossing. Note that the ADC0851 uses only four locations of the status register because it has only four limits. In addition, the tag register is updated so that the register holds the address which indicates the channel and the corresponding upper or lower limit that was crossed. After the first limit crossing is detected, the device cycles through the remaining limits and compares them against their respective input signals. If any additional limit crossing is or are detected then a “1” is stored in the appropriate locations of the status register. After the completion of this operation, the interrupt pin (\overline{INT}) goes low, providing a flag to a microprocessor. The microprocessor can then cause the serial status data to be shifted out by bringing the \overline{CS} line low. Together with the status and tag bits, the microprocessor can determine which channel exceeded which limit. If desired the mi-

Functional Description (Continued)

croprocessor can then initiate an A/D conversion on any channel(s). The ADC0851 includes two additional output pins, COMPL and COMPH. During watchdog operation, if either of the inputs exceeds its respective window bounds then not only is an interrupt generated but a logic low at COMPL or COMPH indicates whether the lower or upper boundary was crossed.

A mode register within the ADC0851/8 allows the device to be used in any one of the eight modes of operation as described in the "general overview" section.

The features described make the ADC0851/8 ideal for use in microprocessor-based automotive, instrumentation and control applications. Such applications often require monitoring of various transducer signals and comparison against pre-programmed window limits. With its watchdog operation, the ADC0851/8 frees up the microprocessor from having to continually monitor the analog variables; the microprocessor is interrupted only when the input signal crosses the preset bounds. Furthermore, the window limits can easily be changed with simple software control.

Applications Information

I. Digital Interface Considerations

The ADC0851 and ADC0858 communicate data serially over the DI (Data Input) and DO (Data Output) pins. The data transfer is synchronous with the external clock (CLK) signal and is clocked in or out of the device at the rising edge of clock. Note that although the output data is clocked out starting at the rising edge of CLK, the data is valid at the falling edge of CLK.

All internal timing in the device is with respect to the oscillator clock. The oscillator frequency is set by connecting a resistor from the OSC pin (pin 2 for ADC0851 or ADC0858) to V_{CC} and a capacitor from the OSC pin to ground. The period of the oscillator clock will determine the A/D conversion time and chip select (\overline{CS}) high duration as will be discussed in the following sections.

1.0 Modes of Operation

To initiate the operation of the device in any one of the eight modes, the chip select (\overline{CS}) line must go low. After a \overline{CS} low is detected, serial input data at the DI pin is clocked in starting at the first rising edge of the serial clock. The first four bits of the input word are reserved for specifying the mode

of operation, with the first bit of the input word always being a logic "1". Table I shows the mode addresses for selecting the different modes of operation.

TABLE I. Modes of Operation

Mode Address				Mode
M3	M2	M1	M0	
1	0	0	0	Watchdog
1	0	0	1	Write One Limit
1	0	1	0	One A/D Conversion
1	0	1	1	Read One Limit
1	1	0	0	Test (for Factory Use Only)
1	1	0	1	Write All Limits
1	1	1	0	Auto A/D Conversion
1	1	1	1	Read All Limits

1.1 POWER FAILURE DETECTION/INITIALIZATION AFTER POWER-UP

Upon power up, the device is automatically configured in the watchdog mode. The status of the power flag bit, P, provides power failure indication to the microprocessor. The timing diagram of Figure 2 shows the sequence of events.

First consider the case of initial power up. After power is applied, \overline{CS} should be brought high. Bringing \overline{CS} high causes the \overline{INT} pin to go low, which signals the microprocessor that a failure has occurred. The microprocessor can then interrogate the device as to the type of failure by bringing \overline{CS} low. When \overline{CS} goes low, it resets the \overline{INT} pin to high and the output data is read starting at the first rising edge of clock (CLK) after \overline{CS} has gone low. Since this is the first read cycle after power up, the power flag bit, P, is set high and appears at the rising edge of the seventeenth clock cycle after \overline{CS} low is detected (Figure 2). After the power flag is read by the microprocessor, \overline{CS} is taken high. Note that the duration for which \overline{CS} remains high (after the power flag is read) must be less than eight oscillator clock periods for ADC0851 and less than thirty-two oscillator clock periods for ADC0858. This is required to interrupt the device from watchdog mode so that when \overline{CS} goes low, the device reads a valid data input (DI) word and configures to a new mode.

During normal operation, the power flag bit is reset to zero after the first "read" cycle and will be updated to a "1" only if a power interruption occurs.

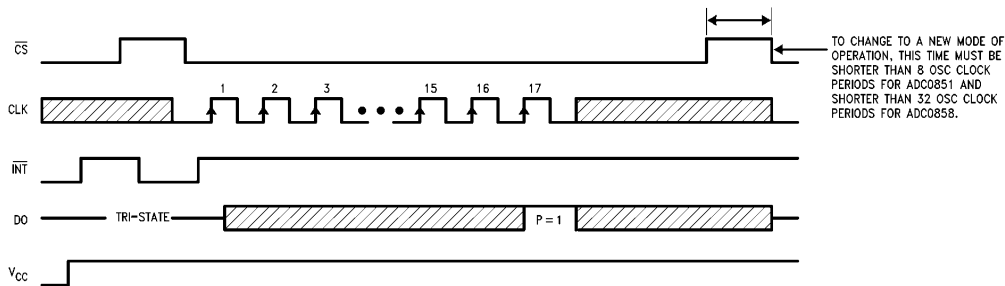

FIGURE 2. Read Power Flag after Power Up ADC0851/ADC0858

TL/H/11021-30

2.0 Memory Access Modes

The ADC0851/8 has an internal RAM with sixteen memory locations (one location for the upper limit and one for the lower limit for each of the 8 input channels). Each memory location is 8 bits wide. An 8-bit limit word representing an upper or lower limit boundary can either be written to or read from the RAM. The ADC0851 uses only four memory locations for the four boundary limits corresponding to the two inputs. The eight channel ADC0858, however, makes use of all sixteen memory locations.

Each memory location is accessed by a specific address as shown by Table II(a) and (b). Note that even addresses correspond to the lower limits while the odd addresses correspond to the upper limits. The ADC0851 and ADC0858 both use 4 bits (A3, . . . A0) to address the RAM, however, ADC0851 decodes only the two LSBs of the address data while ignoring the two MSBs.

TABLE IIa. RAM Address and Limit Data for ADC0851

RAM Address				Corresponding Channel and Limit
A3	A2	A1	A0	
X	X	0	0	CH0–Lower Limit
X	X	0	1	CH0–Upper Limit
X	X	1	0	CH1–Lower Limit
X	X	1	1	CH1–Upper Limit

Limit Data (ADC0851)

L0	L1	L2	L3	L4	L5	L6	L7
----	----	----	----	----	----	----	----

TABLE IIb. RAM Address and Limit Data for ADC0858

RAM Address				Corresponding Channel and Limit
A3	A2	A1	A0	
0	0	0	0	CH0–Lower Limit
0	0	0	1	CH0–Upper Limit
0	0	1	0	CH1–Lower Limit
0	0	1	1	CH1–Upper Limit
0	1	0	0	CH2–Lower Limit
0	1	0	1	CH2–Upper Limit
0	1	1	0	CH3–Lower Limit
0	1	1	1	CH3–Upper Limit
1	0	0	0	CH4–Lower Limit
1	0	0	1	CH4–Upper Limit
1	0	1	0	CH5–Lower Limit
1	0	1	1	CH5–Upper Limit
1	1	0	0	CH6–Lower Limit
1	1	0	1	CH6–Upper Limit
1	1	1	0	CH7–Lower Limit
1	1	1	1	CH7–Upper Limit

Limit Data (ADC0858)

L0	L1	L2	L3	L4	L5	L6	L7
----	----	----	----	----	----	----	----

2.1 WRITE ONE LIMIT

This mode is used to update a single memory location in the limit RAM. An 8-bit limit word is written to the location pointed to by the limit address. From Table I we can see that to initiate the operation of the device in the “write one limit” mode, the mode address has to be 1 0 0 1. The data format for the input word is as shown below.

Data Input (DI) Word—ADC0851 or ADC0858

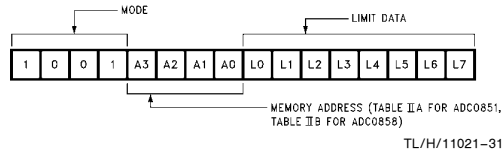

TL/H/11021–31

2.0 Memory Access Modes (Continued)

The address bits access specific memory locations as per Table II(a) and (b) for the ADC0851 and ADC0858 respectively. The address data is clocked in with the MSB (bit A3) first.

The timing diagram in Figure 5 shows that after \overline{CS} goes low, the first four bits of the input word configure the device to “read one limit” mode. Next, the address bits select the desired memory location. Third clock rising edge after the address data’s LSB is loaded, the limit data is output with the LSB (bit L0) first.

2.4 READ ALL LIMITS MODE

With a mode address of 1 1 1 1, the device is configured in the “read all limits mode”. When in this mode, 8-bit limit data from each memory location is serially transmitted out. The data format for the input word is as follows:

Data Input (DI) Word—ADC0851 or ADC0858

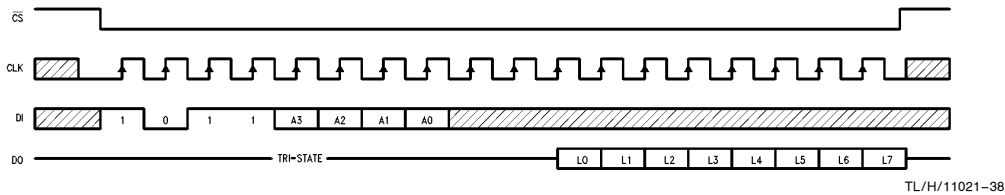
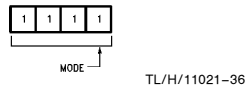

FIGURE 5. Timing Diagram for Read One Limit ADC0851/ADC0858

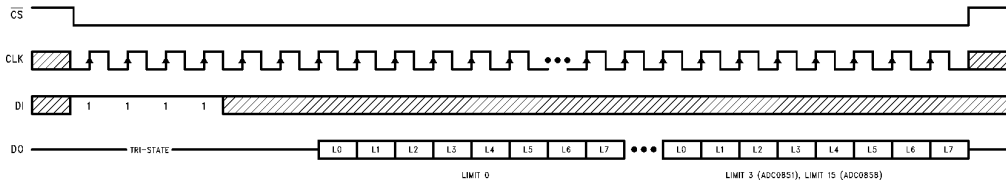

FIGURE 6. Timing Diagram for Read All Limits ADC0851/ADC0858

Note that no memory address data is required. The limit data is sequentially transmitted out starting from the memory location for CH0–Lower Limit and ending at; CH1–Upper Limit for the ADC0851 (see Table II(a)), CH7–Upper Limit for the ADC0858 (see Table II(b)).

The timing diagram of Figure 6 shows that the input data is loaded starting at the first rising edge of CLK after \overline{CS} goes low. Third clock rising edge after the last bit of the input data is loaded, the limit data is serially transmitted out. Four limit words are transmitted for the ADC0851; sixteen for the ADC0858. Each limit word is output with the LSB (bit L0) first. Taking \overline{CS} high after the MSB of the last limit data is transmitted completes the operation.

3.0 Watchdog Mode

This is the primary real time operating mode. During watchdog operation, the upper and lower limits stored in the RAM are applied sequentially to the DAC's digital inputs. The DAC's analog output is applied to the comparator input and compared against the voltage at the enabled analog input pin. The data format for the input word is as shown below.

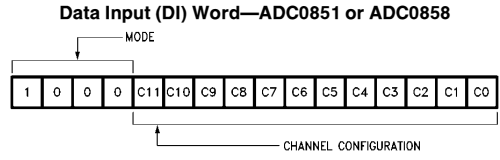

The last twelve bits of the input word assign the multiplexer channel configuration.

3.1 SELECTING THE CHANNEL CONFIGURATION

When the device is either in the watchdog or automatic A/D conversion mode, each pair of analog input channels must be programmed to determine which channel(s) will be active, and whether they will be operating single-ended or differentially. Table III(a) and (b) show the channel addresses for the ADC0851 and the ADC0858 in various channel configurations. When the channels are configured as single-ended inputs, the input voltages are measured with respect to the voltage at the COM pin. Applying a DC voltage at the

COM pin will cause the device to measure the difference between the input signal and the voltage at the COM pin. The voltage at the COM pin has no effect on an input channel that is configured as a differential pair. When the channel pairs are configured as differential inputs (i.e., CH0-CH1, CH2-CH3, etc.) the differential voltage is compared with the limits for the lower numbered channel. For example, the differential voltage CH0-CH1 will be compared with the limits for CH0. Note that the channel pairs are programmed in groups of three bits. The channel address is input to the A/D converter with the MSB (bit C11) first.

The timing diagrams for ADC0851 and ADC0858 watchdog operation are shown in *Figure 7*. After a \overline{CS} low is detected, the input word (DI) is clocked in starting at the first rising edge of the serial clock (CLK). Once the least significant bit of the channel address is loaded, \overline{CS} should go high. Taking \overline{CS} high after the proper input word is loaded initiates the operation of the device in the watchdog mode. To keep the device in continuous watchdog mode, \overline{CS} should remain high for eight or more OSC clock periods for the ADC0851 and thirty-three or more OSC clock periods for the ADC0858. If the input signals are within the boundary limits, the interrupt pin (INT) remains at logic "1" and the Data Output (DO) pin is in TRI-STATE. In addition, in the case of the ADC0851, the COMPL and COMPH pins remain at logic "1".

TABLE IIIa. Multiplexer Channel Configuration (ADC0851)

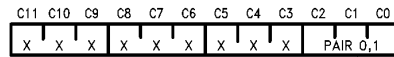

CHANNEL ADDRESS			CHANNEL CONFIGURATION			COMMENTS
C2	C1	C0	CH0	CH1	COM	
0	0	0	+	+	-	BOTH SINGLE-ENDED
1	0	0		+	-	CH1 ONLY
0	1	0	+		-	CH0 ONLY
1	1	0	+	-		DIFFERENTIAL CH0-CH1
X	X	1				CH0 AND CH1 DISABLED

TL/H/11021-40

TABLE IIIb. Multiplexer Channel Configuration (ADC0858)

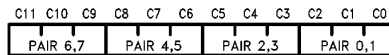

SUBSTITUTE CHANNELS 6 AND 7 INTO TABLE
 SUBSTITUTE CHANNELS 4 AND 5 INTO TABLE
 X = DON'T CARE
 SUBSTITUTE CHANNELS 2 AND 3 INTO TABLE

CHANNEL ADDRESS			CHANNEL CONFIGURATION			COMMENTS
C2	C1	C0	CH0	CH1	COM	
0	0	0	+	+	-	BOTH SINGLE-ENDED
1	0	0		+	-	CH1 ONLY
0	1	0	+		-	CH0 ONLY
1	1	0	+	-		DIFFERENTIAL CH0-CH1
X	X	1				CH0 AND CH1 DISABLED

TL/H/11021-41

3.0 Watchdog Mode (Continued)

The device will read the new input word and configure to a different mode if \overline{CS} is high for less than eight oscillator clock periods for the ADC0851 and less than thirty-two oscillator clock periods for the ADC0858.

Once a boundary limit is crossed, \overline{INT} goes low. Moreover, for ADC0851, COMPL goes low if a lower limit is crossed, whereas COMPH goes low if an upper limit is crossed. If the input signals exceed both the upper and lower boundary limits then both COMPL and COMPH would go low.

To output data after a limit crossing occurs (i.e., after \overline{INT} goes low), \overline{CS} should be brought low. Note that \overline{INT} , COMPL and COMPH would remain low as long as \overline{CS} doesn't go low. After \overline{CS} goes low \overline{INT} , COMPL and COMPH go high and one clock cycle later output data is transmitted starting at the first rising edge of CLK, however, the data is valid at the falling edge of CLK (Figure 7).

3.2 LIMIT CROSSING DETECTION

When the ADC0851/8 is configured in the watchdog mode, the device operates as a window comparator. First the lower window limit (stored in the RAM) for CH0 is compared against the input voltage at CH0. If the input voltage is greater than the lower limit, then no interrupt is generated. Next the upper window limit for CH0 is compared against CH0 input voltage. If the input voltage is less than the upper window limit then no interrupt is generated for CH0 and the device starts a similar comparison cycle for the next channel (CH1). Note that the lower limit can be greater than the upper limit; in this case the device will flag the microprocessor if the input signal falls inside a window.

TABLE IVa. Channel Tag Address and Status (ADC0851)

Tag #	Tag Address				Corresponding Limit and Channel
	T3	T2	T1	T0	
0	0	0	0	0	Lower Limit—CH0
1	0	0	0	1	Upper Limit—CH0
2	0	0	1	0	Lower Limit—CH1
3	0	0	1	1	Upper Limit—CH1

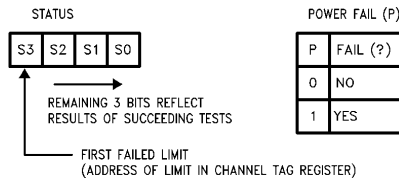

TL/H/11021-43

TABLE IVb. Channel Tag Address and Status (ADC0858)

Tag #	Tag Address				Corresponding Limit and Channel
	T3	T2	T1	T0	
0	0	0	0	0	Lower Limit—CH0
1	0	0	0	1	Upper Limit—CH0
2	0	0	1	0	Lower Limit—CH1
3	0	0	1	1	Upper Limit—CH1
4	0	1	0	0	Lower Limit—CH2
5	0	1	0	1	Upper Limit—CH2
6	0	1	1	0	Lower Limit—CH3
7	0	1	1	1	Upper Limit—CH3
8	1	0	0	0	Lower Limit—CH4
9	1	0	0	1	Upper Limit—CH4
10	1	0	1	0	Lower Limit—CH5
11	1	0	1	1	Upper Limit—CH5
12	1	1	0	0	Lower Limit—CH6
13	1	1	0	1	Upper Limit—CH6
14	1	1	1	0	Lower Limit—CH7
15	1	1	1	1	Upper Limit—CH7

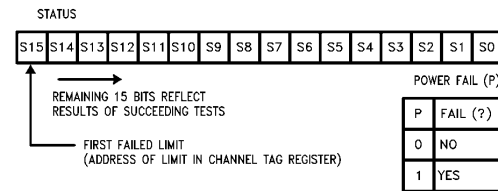

TL/H/11021-44

Each comparison takes 2 μ s; thus a total of 4 μ s is required per channel.

When in watchdog mode, the device will continuously cycle through the input channels until an input that has crossed its preset window limit is detected. When this occurs, a logical "1" is stored in the MSB (bit S3 for ADC0851 and S15 for ADC0858) position of the status register. In addition the tag register is updated with the channel's address (see Tables IV(a) and (b) for ADC0851 and ADC0858 respectively). Note that the tag address indicates which channel crossed which limit. Once the tag register is updated after the first limit is crossed, the device will once more cycle through the remaining channels and compare the input voltages against

3.0 Watchdog Mode (Continued)

their respective window limits. A logical "1" will be placed in the appropriate location of the status register for each limit that is crossed as the device cycles through the remaining channels. Note that the tag register is updated only once i.e., when the first limit is exceeded. After the last limit comparison is made subsequent to the first limit crossing, the device will cease any further limit comparisons and will cause the interrupt pin to go low. Taking \overline{CS} low causes the data in the status and tag registers to be transmitted along with the programmed channel configuration information. In addition, an extra bit, P, is inserted between the channel and status information. This bit is updated to a logic "1" in case of a power interruption.

The format for the output data is as shown below.

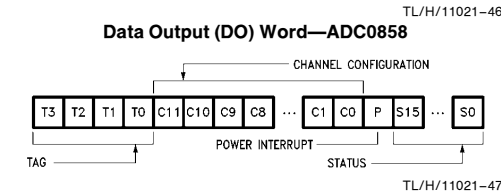
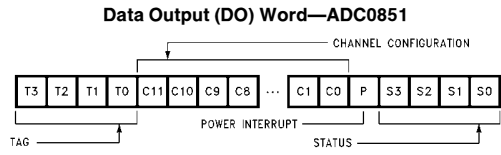

The order in which data is transmitted is as follows (ADC0851 or ADC0858):

- Tags (4 bits)—MSB (T3) first
- Channel configuration (12 bits)—MSB (C11) first
- Power interrupt (1 bit)
- Status (4 bits for ADC0851, 16 bits for ADC0858)—MSB (S3/S15) first

It is important to note that any channel that is disabled will not cause an interrupt. Furthermore, when operated in the differential mode, the arithmetic difference of the two voltages will be compared with the lower and upper limits for the lower numbered channel. For example, with CH0 and CH1 operating as a differential input pair, the CH0 limits will apply.

Consider an example where the lower limit of CH1 is crossed first and while the remaining limits are being checked, the upper limit of CH0 is crossed. *Figure 8* illustrates the sequence of events for the ADC0851. During watchdog operation, CH0's lower limit stored in the RAM is compared against the input voltage at CH0. Since no limit crossing is detected, the upper limit is compared against CH0 input voltage. Again no limit crossing is detected and so CH1's lower limit is next compared against the CH1 input voltage. This time a limit crossing is detected and a logic "1" is now stored in the MSB (S3) position of the status register (see Table IV(a)). Also the Tag register is updated with the corresponding address (0 0 1 0) from Table IV(a). The device now cycles through the remaining channels once more. Since no limit crossing is detected for the upper limit of CH1, a logic "0" is stored for S2 of the status register. Similarly a logic "0" is stored for S1 of the status register. Finally to complete the cycle, the last limit (upper limit of CH0) is checked and a limit crossing is detected. Consequently, a logic "1" is stored for S0. Note that the Tag regis-

ter is only updated once when the first limit crossing is detected thus indicating which channel first exceeded its lower or upper limit.

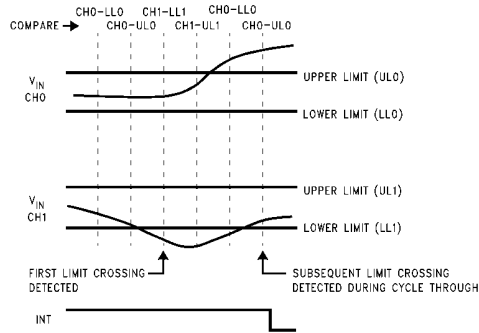

(Example: Lower limit of CH1 is crossed first. During cycle through, upper limit of CH0 is crossed)

FIGURE 8. Example of Limit Crossing Detection (ADC0851)

Assuming that there is no power interruption and that the ADC0851 was configured for single ended operation, the output word for our example would be:

(Example of ADC0851 Data Output. Single ended input. Lower limit of CH1 fails first. During cycle through, upper limit—CH0 failure is detected).

0 0 1 0 X X X X X ... 0 0 0 1 0 0 1

T3 T2 T1 T0 C11 C10 C9 C8 C7 C1 C0 P S3 S2 S1 S0
X = Don't care, whatever bit was initially programmed (ADC0851 only).

The ADC0858 operates similar to the ADC0851 except that the ADC0858 has a 16-bit status word for the sixteen limits and sixteen tag addresses (See Table IV(b)). The output word transmitted to the microprocessor not only contains information as to how the channels are configured but also which input crossed which limit. If desired, the microprocessor can go through a status bit normalization routine to normalize the status information with the tag number as will be discussed next.

3.3 STATUS BIT NORMALIZATION

Figure 9 shows the procedure for normalizing the status information. Let's consider the example cited earlier for the ADC0851. In our example, the lower limit of CH1 was crossed first and during cycle-through, upper limit—CH0 crossing was detected. The serial status data is thus 1 0 0 1 and the tag data 0 0 1 0 corresponds to tag #2 (see Table IV(a)). Since the most significant bit (S3) of the status data is transmitted first, the data stored in the microprocessor's memory is 1 0 0 1. The microprocessor next computes the tag number from the tag data and rotates the status bits left "TAG" places as in *Figure 9*. For our example, the status bits are rotated by shifting left 2 places. The status information in the microprocessor's memory is now normalized i.e., U0 corresponds to tag 0, U1 corresponds to tag 1 and so on. From the example in *Figure 9* we can see that the status register in the microprocessor's memory shows that tag 2 and tag 1 failed. The ADC0858 uses a 16-bit status word and operates similar to the ADC0851. An example shown in *Figure 9* for the ADC0858 demonstrates how status bit normalization is carried out.

3.0 Watchdog Mode (Continued)

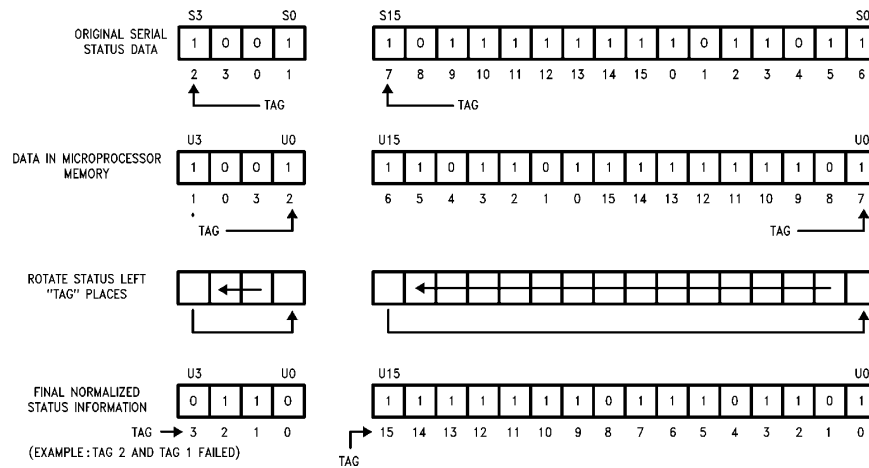

FIGURE 9. Status Bit Normalization

TL/H/11021-48

4.0 A/D Conversion Modes

The ADC0851/8 can be used in two A/D conversion modes. In "One A/D conversion" mode, the device operates as a multiplexed A/D converter and a conversion may be initiated on any channel or channel pair configured in the differential mode. In the "Automatic A/D conversion" mode, an A/D conversion is done on a channel or channel pair and after the output data is transmitted, conversion begins on the next subsequent channel or channel pair. This process will continue unless the device's mode of operation is changed.

Note that the A/D conversion time is determined by the oscillator clock period and has no relation with the digital clock signal, CLK. The oscillator clock's frequency is set by connecting a resistor from the OSC pin (pin 2 for ADC0851 or ADC0858) to V_{CC} and a capacitor from the OSC pin to ground. The conversion time of the A/D converter is eighteen OSC clock periods maximum. Assuming that the oscillation clock frequency is set at 1 MHz (with R_{ext} = 3.16 kΩ and C_{ext} = 170 pF) then the conversion time would be 18 μs maximum.

4.1 ONE A/D CONVERSION MODE

This mode is used to initiate one A/D conversion on a single channel or channel pair configured in the differential mode. The necessary mode address as per Table I is 1 0 1 0. The format for the input word is as follows:

Data Input (DI) word—ADC0851 or ADC0858.

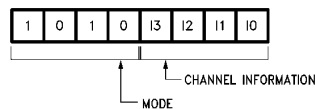

TL/H/11021-49

(Table V(a) for ADC0851, Table V(b) for ADC0858)

The 4-bit data following the mode address is the channel information address. These four bits assign the MUX configuration for the single A/D conversion. The channel information addresses and the corresponding MUX configurations are shown in Table V(a) and (b) for ADC0851 and ADC0858 respectively. Note that the ADC0851 only decodes the two LSBs of the channel information data while ignoring the two MSBs (I3 and I2). When a channel pair is configured in the differential mode, it is important to note that the arithmetic difference of the channel voltages should not be negative. Negative difference voltage would result in all zeroes at the output.

TABLE V(a). Channel Information for One A/D Conversion (ADC0851)

Channel Information				Channels Enabled
I3	I2	I1	I0	
X	X	0	0	CH0
X	X	0	1	CH0-CH1
X	X	1	0	CH1
X	X	1	1	Invalid

4.0 A/D Conversion Modes (Continued)

TABLE V(b). Channel Information for One A/D Conversion (ADC0858)

Channel Information				Channels Enabled
I3	I2	I1	I0	
0	0	0	0	CH0
0	0	0	1	CH0–CH1
0	0	1	0	CH1
0	0	1	1	Invalid
0	1	0	0	CH2
0	1	0	1	CH2–CH3
0	1	1	0	CH3
0	1	1	1	Invalid
1	0	0	0	CH4
1	0	0	1	CH4–CH5
1	0	1	0	CH5
1	0	1	1	Invalid
1	1	0	0	CH6
1	1	0	1	CH6–CH7
1	1	1	0	CH7
1	1	1	1	Invalid

The timing diagram for one A/D conversion is shown in *Figure 10*. After \overline{CS} goes low, the input word (DI) is clocked in starting at the first rising edge of the digital clock signal, CLK. The first four bits of the input word configure the device for “one A/D conversion” mode while the following four bits (channel information address) assign the configuration of the MUX as per Table V(a) and (b) for the ADC0851 and ADC0858 respectively. Any input data following the channel information address is ignored until the device’s mode of operation is changed.

Taking \overline{CS} high after the last bit of the channel information address loads the input word. Had \overline{CS} been kept low longer, the following bits of the input word would have been ignored. The device takes one to two OSC clock periods after \overline{CS} goes high to initiate the start of A/D conversion. The EOC output goes low, thus signalling the start of the conversion process. After a maximum of eighteen OSC clock periods, conversion is completed and EOC output goes high, thus signalling the end of conversion. The output data is now available and will be transmitted only if \overline{CS} is brought low. The output data is transmitted starting at the first rising edge of CLK after \overline{CS} goes low.

The format for the output word is as shown below.

Data Output (DO)—ADC0851 or ADC0858

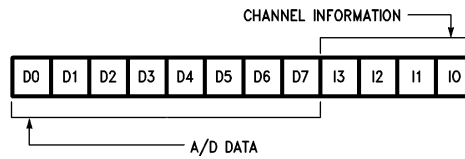

TL/H/11021–50

The first eight bits of the output word represent the digital equivalent of the input voltage. Bits I3 through I0 provide the channel configuration information as per Table V(a) and (b) for ADC0851 and ADC0858 respectively. Note that this information is the same as the channel information in the input word. The order in which the output data is transmitted is as follows:

- Data—LSB (D0) first
- Channel information—MSB (I3) first

Note that the output will be TRI-STATE if \overline{CS} remains low after I0 is transmitted. Taking \overline{CS} high after the output data is transmitted causes the device to initiate the start of the next A/D conversion on the same input while ignoring the data input word (DI). If the duration for which \overline{CS} is high is less than seventeen OSC clock periods, the conversion process will be interrupted and the device will look for the mode address at the falling edge of \overline{CS} so as to configure to a new mode of operation. However, if \overline{CS} is high for eighteen or more OSC clock periods then the conversion operation will continue from point A on the timing diagram (*Figure 10*).

To ensure repetitive A/D conversion on the same input, \overline{CS} going low should be synchronized with EOC going high. Thus after EOC goes high, the conversion is completed and \overline{CS} can go low to transmit the output data. Meanwhile, if \overline{CS} goes low while EOC is low then the conversion process is interrupted and the device is readied for a new mode of operation.

4.2 AUTO A/D CONVERSION MODE

When used in this mode, the ADC0851/8 offers added flexibility that many multiplexed A/D converters don’t. In the auto A/D conversion mode, the ADC0851/8 scans through the selected input channels, performing A/D conversion on each channel without the need for reloading a new data input word each time. From Table I, the mode address for the “Auto A/D Conversion” mode is 1 1 1 0.

The format for the input word is as follows:

Data Input (DI) Word—ADC0851 or ADC0858

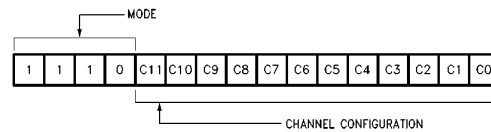

TL/H/11021–51

4.0 A/D Conversion Modes (Continued)

The 12-bit channel address following the mode address assigns the MUX configuration as per Table III(a) and (b) for ADC0851 and ADC0858 respectively. Note that the ADC0851 only decodes the three LSBs (C0, C1 and C2) of the channel address.

The timing diagram for "Auto A/D Conversion" mode is shown in Figure 11. The input word is loaded starting at the first rising edge of the CLK after \overline{CS} goes low. The first four bits configure the device for the "Auto A/D Conversion" mode while the 12-bit channel address assigns the configuration of each channel pair. If \overline{CS} remains low after C0 is loaded then any subsequent input data is ignored. Taking \overline{CS} high after the input word is loaded initiates the start of A/D conversion. A/D conversion starts one to two OSC clock periods after \overline{CS} goes high. The EOC output goes low to signal the start of an A/D conversion. The conversion time may range from 17 μs to 74 μs depending on how

the channel pairs are configured. The EOC output goes high at the end of conversion thus signalling that the result of the A/D conversion can now be retrieved. The output data will be transmitted only if \overline{CS} goes low and is transmitted starting at the first rising edge of CLK signal after \overline{CS} goes low. The format for the output word is as follows:

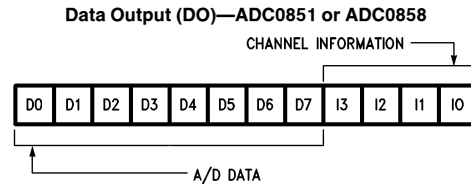

TL/H/11021-52

4.0 A/D Conversion Modes (Continued)

The first eight bits of the output word represents the digital equivalent of the analog input voltage. Status bits I3 through I0 provide the channel configuration information as per Table V(a) and (b) for ADC0851 and ADC0858 respectively.

Keeping \overline{CS} low after I0 is transmitted causes the output to be TRI-STATE. Once the output data is transmitted, \overline{CS} may go high to initiate the start of the next A/D conversion. The subsequent A/D conversion starts on the next channel pair that is configured as per the initially loaded input word (Figure 11). Any data on the data input (DI) line is ignored. Note that if the duration for which \overline{CS} is high is less than seventeen OSC clock periods then the conversion process would be interrupted and the device would look for the mode address at the falling edge of \overline{CS} so that a new mode of operation can be configured.

To ensure proper operation in the "Auto A/D Conversion" mode, \overline{CS} going low should be synchronized with EOC going high. Thus after EOC goes high, the conversion is completed and \overline{CS} can go low to transmit the output data. After the output data is transmitted, \overline{CS} should go high to initiate automatic A/D conversion on the next channel pair and remain high until the conversion is completed and EOC goes high. Meanwhile, if \overline{CS} goes low while EOC is low then the conversion process is interrupted and the device is readied for a new mode of operation.

5.0 Test Mode

A mode address of 1 1 0 0 configures the device in the test mode. This mode is used to test the internal operation of the device at the factory and is not recommended for normal use. If the device is accidentally configured in the test mode then the power supply must be disconnected and reconnected again to reset the device.

6.0 Bidirectional I/O

If the microprocessor has bidirectional Input/Output capability then ADC0851/8's input and output pins can be tied together and a single wire can be used to serially input data to or output data from ADC0851/8. This capability is made possible because when the input word is clocked in, the output pin is in TRI-STATE and when the output word is clocked out, the data at the input pin is ignored.

II. Analog Considerations

1.0 A/D Conversion Time

The A/D conversion time is a function of the OSC clock frequency. The oscillator frequency is set by connecting an external resistor, R_{ext} from the ADC0851/8's OSC pin to V_{CC} and an external capacitor, C_{ext} from the OSC pin to ground. With $R_{ext} = 3.16 \text{ k}\Omega$ and $C_{ext} = 170 \text{ pF}$, the OSC frequency is 1 MHz at $V_{CC} = 4.5\text{V}$ and 1.05 MHz at $V_{CC} = 5.5\text{V}$.

The OSC frequency will vary as the ambient temperature varies, this is shown by the Typical Performance Characteristics curve, "OSC Frequency vs Temperature". For a specified external resistor, the OSC frequency can be changed by varying the external capacitor as is shown by the Typical Performance Characteristics curve, "OSC Frequency vs R_{ext} and C_{ext} ". Note that the OSC pin of the ADC0851/8 should not be driven by an external clock as this might

cause improper operation. The A/D converter's conversion time is a minimum of seventeen OSC clock periods and a maximum of eighteen. Figure 12 shows a typical connection for the ADC0851 and ADC0858.

2.0 The Reference

The magnitude of the reference voltage (V_{REF}) applied to the A/D converter determines the analog input voltage span (i.e., the difference between $V_{IN(max)}$ and $V_{IN(min)}$) over which the 256 possible output codes apply. The reference voltage source connected to the V_{REF} pin of ADC0851/8 must be capable of driving a minimum load of 4 k Ω .

The ADC0851/8 can be used in either ratiometric applications or in systems requiring absolute accuracy. In a ratiometric system, the analog input voltage is proportional to the voltage used for the A/D's reference. This voltage is usually the system power supply, so the V_{REF} pin can be tied to V_{CC} .

For absolute accuracy, where the analog input varies between very specific voltage limits, the reference pin must be connected to a voltage source that is stable over time and temperature. The LM385 and LM336 micropower references are good low current devices for use with these A/D converters.

The maximum value of the reference voltage is limited by the A/D converter's power supply voltage, V_{CC} . The minimum value, however, can be as low as 1V while maintaining a typical Integral Linearity of ± 1 LSB (see Typical Performance Characteristics curve, "Linearity Error vs Reference voltage"). This allows direct conversion of transducer outputs that provide less than a 5V output span. Due to the increased sensitivity of the A/D converter at low reference voltages (e.g., 1 LSB = 3.9 mV for a 1V full scale range), care must be exercised with regard to noise pickup, circuit layout, and system error voltage sources.

3.0 The Analog Inputs

3.1 REDUCING COMMON MODE ERROR

Rejection of common mode noise can be achieved by configuring the ADC0851/8's inputs in the differential mode since the offending common mode signal is common to both the selected "+" and "-" inputs. The time interval between sampling the "+" input and the "-" input is one oscillator clock period. A change in the common-mode voltage during this short time interval can cause conversion errors. For a sinusoidal common-mode signal this error is:

$$V_{error(Max)} = V_{PEAK}(2\pi f_{CM}) (1/f_{OSC})$$

where f_{CM} is the frequency of the common-mode signal, V_{PEAK} is the signal's peak voltage and f_{OSC} is the A/D converter's OSC clock frequency.

For a 60 Hz common-mode signal to generate a $1/4$ LSB error ($\approx 5 \text{ mV}$ for a 5V full scale range) with the converter running at $f_{OSC} = 250 \text{ kHz}$, its peak voltage would have to be 3.3V.

3.2 SOURCE RESISTANCE

For a source resistance under 2 k Ω , the ADC0851/8's total unadjusted error is typically ± 0.2 LSB at $V_{REF} = 4.75\text{V}$ and $f_{OSC} \leq 1 \text{ MHz}$ (see Typical Performance Characteristics curves, "Total Unadjusted Error vs Source Impedance").

One source of error is the multiplexer's leakage current of 3 μA which contributes a 3 mV drop across a 1 k Ω source

3.0 The Analog Inputs (Continued)

resistance. Another source of error is the sampling nature of the A/D converter. Short spikes of current enter the “+” input and exit the “-” input at the rising and falling transition of the OSC clock. These currents decay rapidly and generally do not cause errors since the internal comparator is strobed at the end of a clock period. If large source resistances are used however, then the transients caused by the current spikes may not settle completely before conversion begins. If a capacitor is used at the input of the A/D converter for input filtering then the input signal source resistance should be kept at 1 kΩ or less.

3.3 ANALOG INPUT PROTECTION

Often the analog inputs of A/D converters are driven from voltage sources that can swing higher than V_{CC} or lower than GND. Analog inputs often come from op amps which use $\pm 15V$ supplies. While during normal operation the input voltages stay within the 0V–5V A/D converter supply voltage range, at power up the input voltage may actually rise above or fall below the A/D converter’s supply voltages. If the input voltage to any A/D converter input pin does fall outside the supply voltage by more than 0.3V (worst case) and the input draws more than 5 mA then there is a good possibility that the converter may latch up and provide a low impedance short between V_{CC} and GND.

Figure 13 shows the overvoltage protection circuit for the analog input. If, for instance, the amplifier’s output saturates to its positive supply rail, then the junction of R1 and R2 would be clamped to V_{CC} plus a diode drop. Resistor R1 limits the op amp’s output current and R2 limits the current flowing into the input of the A/D converter. Likewise, the junction of R1 and R2 would be clamped to a diode drop below ground if the op amp’s output saturates to the negative rail.

4.0 Zero Scale and Full Scale Adjustment

4.1 ZERO SCALE ERROR

The zero scale error of the A/D converter does not require adjustment. If the minimum analog input voltage value, $V_{IN(Min)}$, is not at ground potential then a zero offset can be done. The converter can be made to output 0000 0000 digital code for this minimum input voltage by biasing the $V_{IN(-)}$

input of a differential input pair at this $V_{IN(Min)}$ value. This utilizes the differential mode operation of the A/D converter.

The zero scale error of the A/D converter relates to the location of the first riser of the transfer function and can be measured by grounding the $V_{IN(-)}$ input and applying a small magnitude positive voltage to the $V_{IN(+)}$ input. Zero error is the difference between the actual DC input voltage (the ideal $\frac{1}{2}$ LSB value, $\frac{1}{2}$ LSB = 9.8 mV for $V_{REF} = 5.000 V_{DC}$) and the applied input voltage that causes an output digital code transition from 0000 0000 to 0000 0001.

4.2 FULL SCALE ADJUSTMENT

The full-scale adjustment can be made by applying an input voltage that is 1.5 LSB less than the desired analog full-scale voltage and then adjusting the magnitude of the V_{REF} input voltage for a digital output code that just changes from 1111 1110 to 1111 1111.

4.3 ADJUSTING FOR AN ARBITRARY ANALOG INPUT VOLTAGE RANGE

Analog input voltages that span from a positive non-zero minimum value can easily be accommodated by the ADC0851/8. In this case, the A/D converter is used in the differential mode and a reference voltage equal to $V_{IN(Min)}$ is applied to the $V_{IN(-)}$ input. Normally zero scale adjustment is not required because the zero scale error is very small. However, if zero scale adjustment is desired then a voltage equal to $V_{IN(Min)}$ plus $\frac{1}{2}$ LSB (where 1 LSB = Input voltage span/256) should be applied to $V_{IN(+)}$ and the reference voltage at $V_{IN(-)}$ should be adjusted such that the output code just changes from 0000 0000 to 0000 0001.

Once the proper reference voltage is applied to the $V_{IN(-)}$ input then full scale adjustment can be made. Full scale adjustment is made by first applying a voltage to the $V_{IN(+)}$ input that is 1.5 LSB less than $V_{IN(Max)}$ i.e.;

$$V_{IN(+)} \text{ FS ADJ} = V_{Max} - 1.5 [(V_{Max} - V_{Min})/256]$$

where, V_{Max} = the high end of the analog input voltage range

V_{Min} = the low end of the analog input voltage range

The reference voltage, V_{REF} applied to the reference input pin of the A/D converter is adjusted so that the output code just changes from 1111 1110 to 1111 1111. This completes the adjustment procedure.

Typical Applications

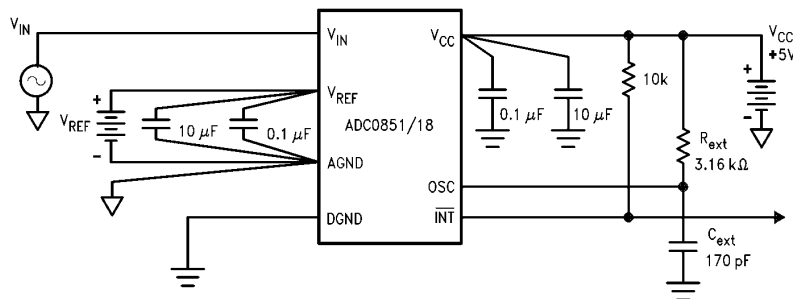
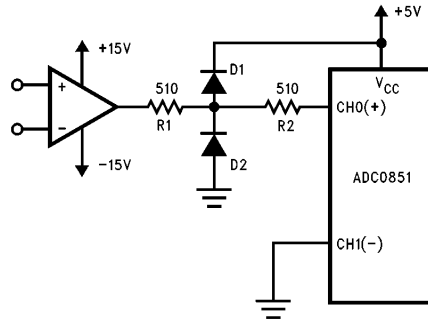

FIGURE 12. Recommended Connection for ADC0851 and ADC0858

TL/H/11021-55

Typical Applications (Continued)



TL/H/11021-56

FIGURE 13. Over Voltage Protection of the Analog Inputs

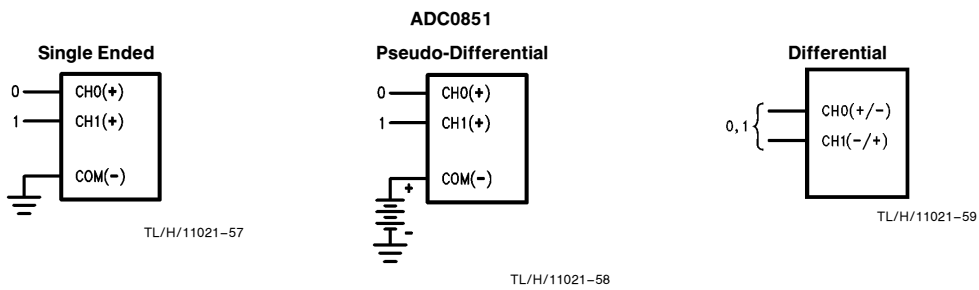

FIGURE 14. Analog Input Multiplexer Options for ADC0851

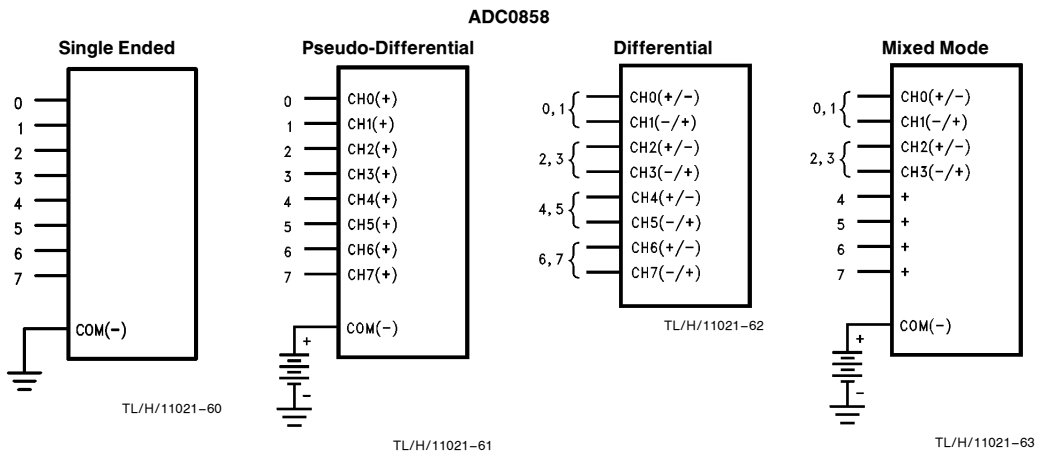
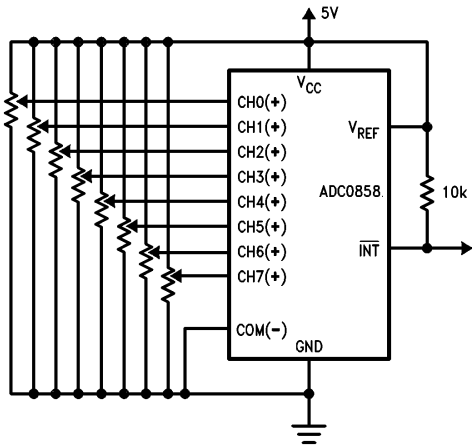

FIGURE 15. Analog Input Multiplexer Options for ADC0858

Typical Applications (Continued)



TL/H/11021-64

FIGURE 16. Adaptive Instrumentation Control (Ratiometric Operation) with Over Range Flag

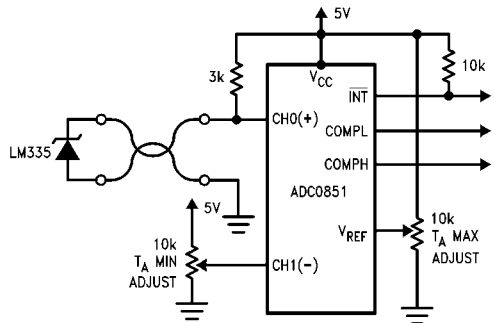

TL/H/11021-65

FIGURE 17. Remote Temperature Sensor with Over Range Flag

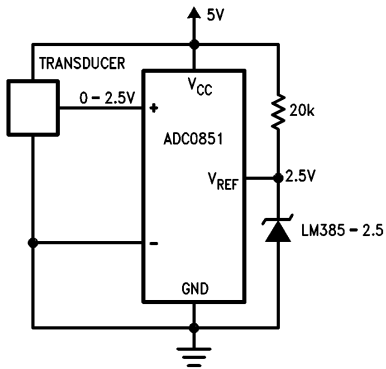

TL/H/11021-66

FIGURE 18. Absolute Input with 2.5V Input Voltage Span

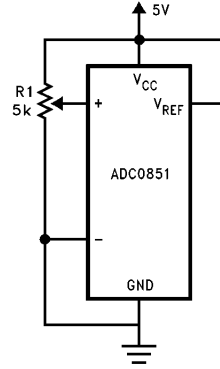

TL/H/11021-67

FIGURE 19. Single Channel Ratiometric Operation

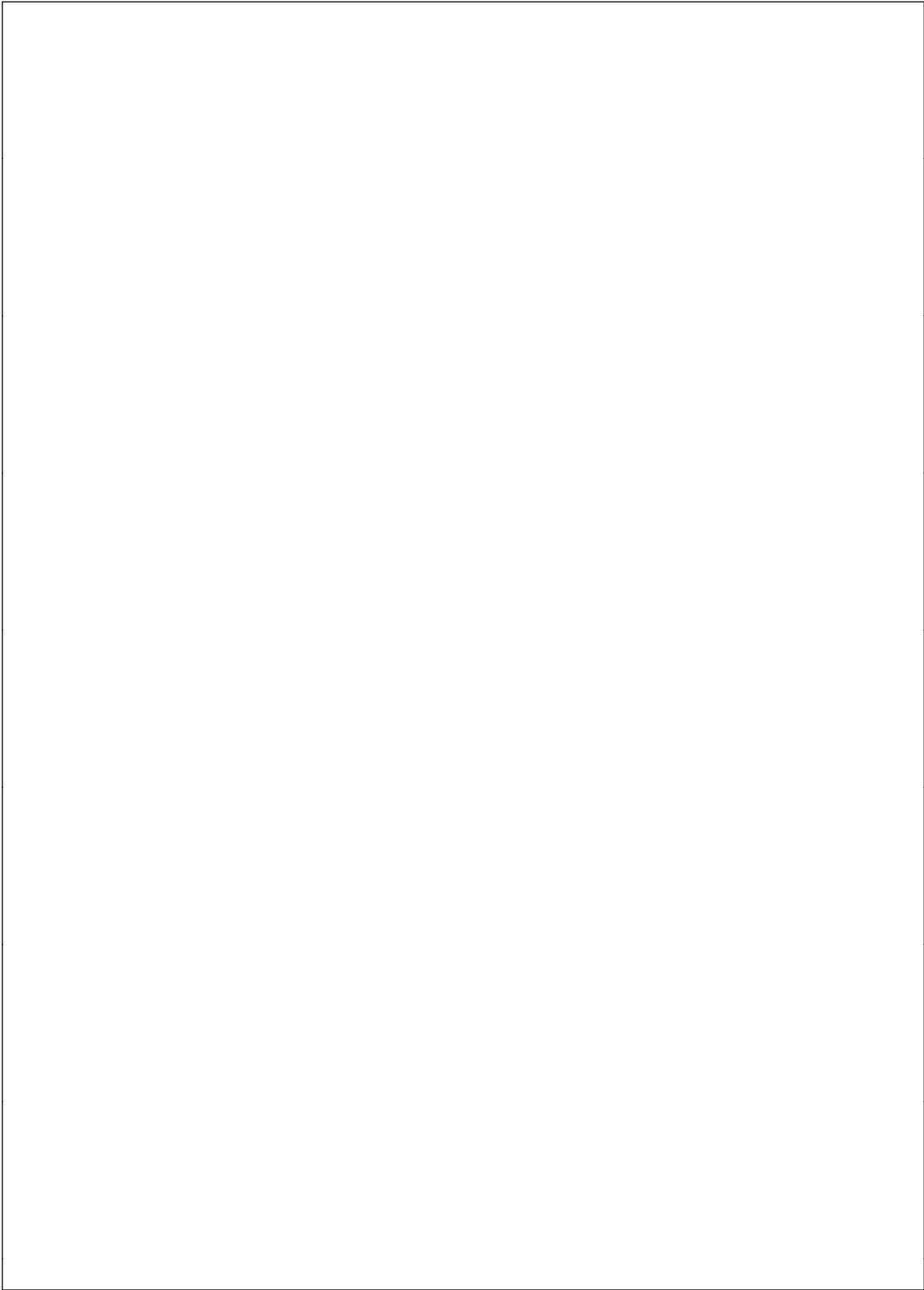

Physical Dimensions inches (millimeters)

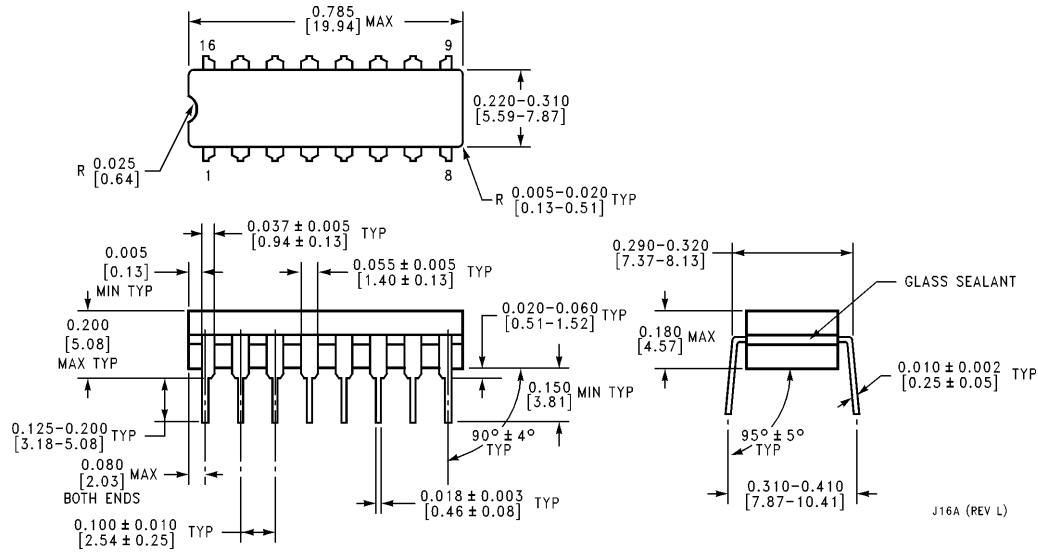

16-Pin Ceramic DIP
Order Number ADC0851CMJ/883
NS Package Number J16A

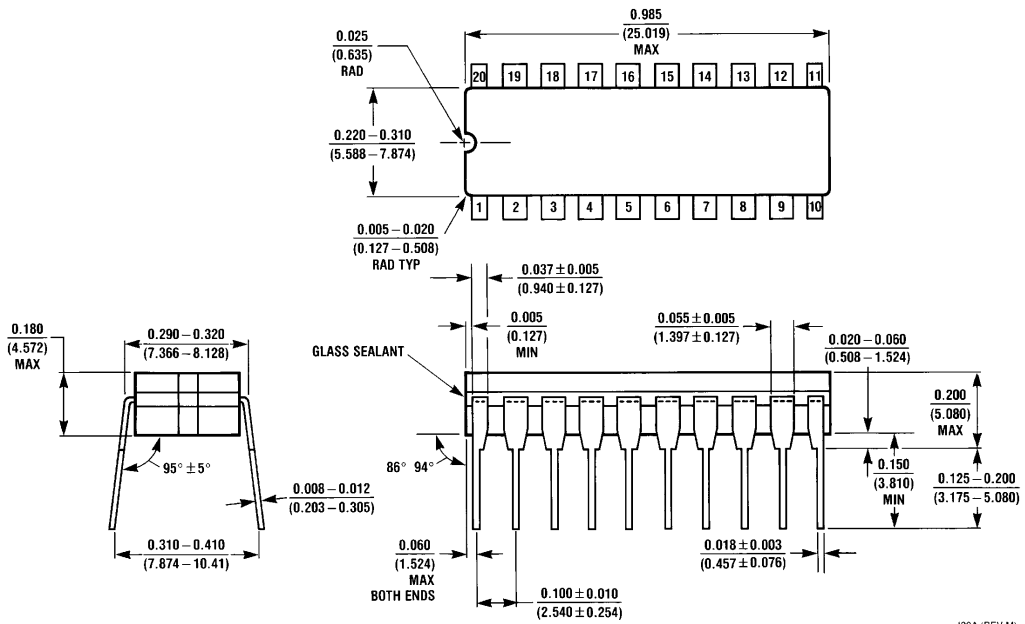

20-Pin Ceramic DIP
Order Number ADC0858CMJ/883
NS Package Number J20A

Physical Dimensions inches (millimeters) (Continued)

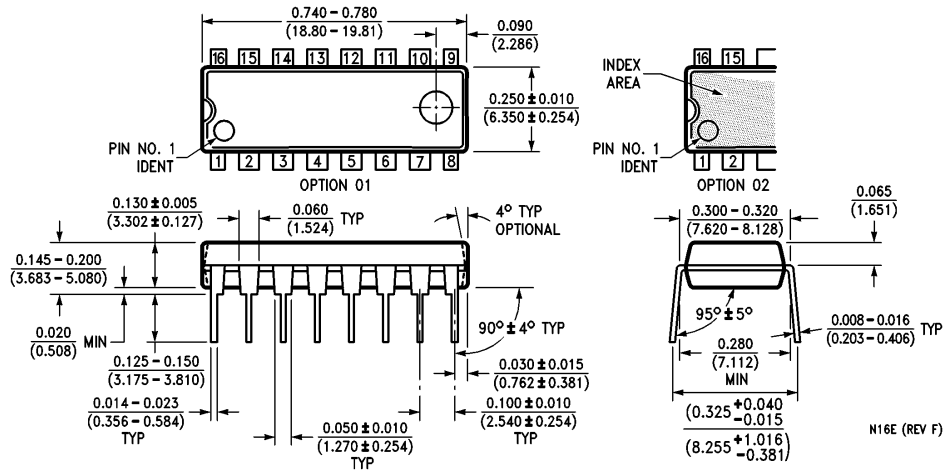

16-Pin Plastic DIP
Order Number ADC0851BIN or ADC0851CIN
NS Package Number N16E

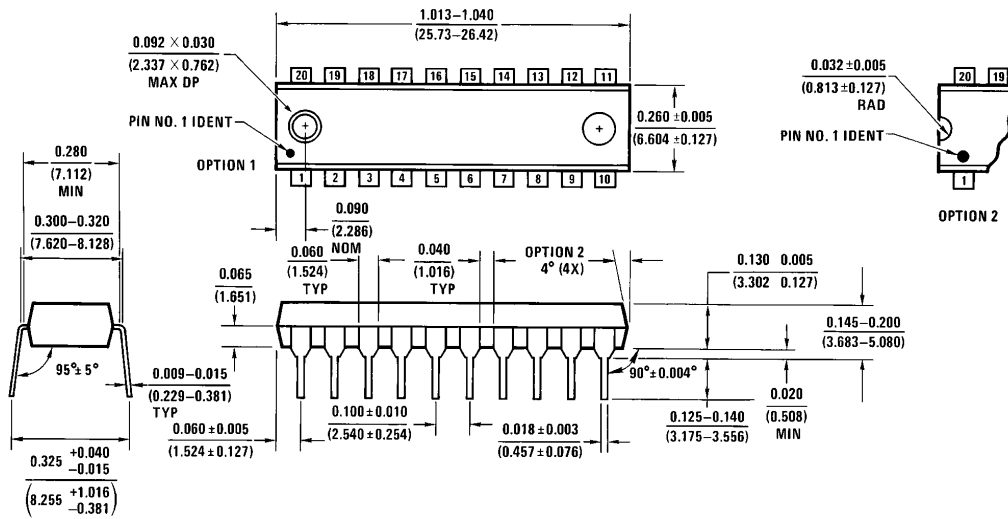

20-Pin Plastic DIP
Order Number ADC0858BIN or ADC0858CIN
NS Package Number N20A

Physical Dimensions inches (millimeters) (Continued)

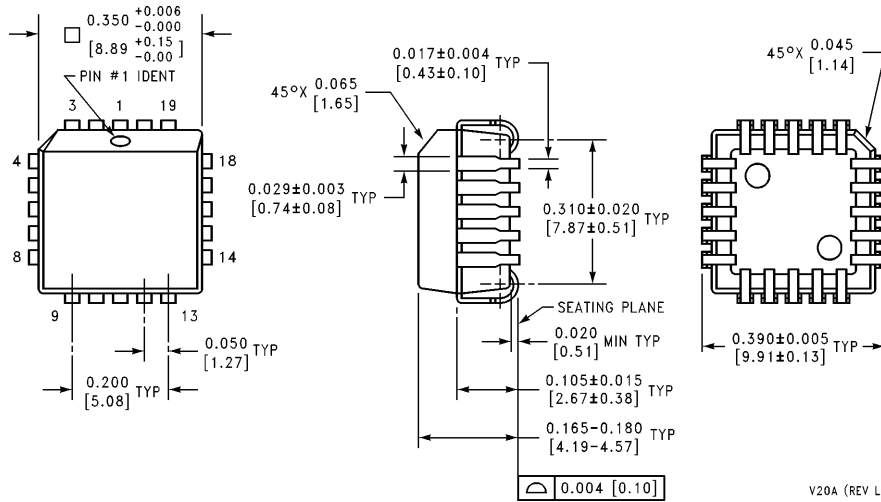

20-Lead PLCC
Order Number ADC0851BIV, ADC0851CIV,
ADC0858BIV or ADC0858CIV
NS Package Number V20A

V20A (REV L)

LIFE SUPPORT POLICY

NATIONAL'S PRODUCTS ARE NOT AUTHORIZED FOR USE AS CRITICAL COMPONENTS IN LIFE SUPPORT DEVICES OR SYSTEMS WITHOUT THE EXPRESS WRITTEN APPROVAL OF THE PRESIDENT OF NATIONAL SEMICONDUCTOR CORPORATION. As used herein:

1. Life support devices or systems are devices or systems which, (a) are intended for surgical implant into the body, or (b) support or sustain life, and whose failure to perform, when properly used in accordance with instructions for use provided in the labeling, can be reasonably expected to result in a significant injury to the user.
2. A critical component is any component of a life support device or system whose failure to perform can be reasonably expected to cause the failure of the life support device or system, or to affect its safety or effectiveness.



National Semiconductor Corporation
 2900 Semiconductor Drive
 P.O. Box 58090
 Santa Clara, CA 95052-8090
 Tel: (800) 272-9959
 TWX: (910) 339-9240

National Semiconductor GmbH
 Livny-Gargan-Str. 10
 D-82256 Fürstenfeldbruck
 Germany
 Tel: (81-41) 35-0
 Telex: 527849
 Fax: (81-41) 35-1

National Semiconductor Japan Ltd.
 Sumitomo Chemical
 Engineering Center
 Bldg. 7F
 1-7-1, Nakase, Mihama-Ku
 Chiba-City,
 Chiba Prefecture 261
 Tel: (043) 299-2300
 Fax: (043) 299-2500

National Semiconductor Hong Kong Ltd.
 13th Floor, Straight Block,
 Ocean Centre, 5 Canton Rd.
 Tsimshatsui, Kowloon
 Hong Kong
 Tel: (852) 2737-1600
 Fax: (852) 2736-9960

National Semicondutores Do Brazil Ltda.
 Rue Deputado Lacorda Franco
 120-3A
 Sao Paulo-SP
 Brazil 05418-000
 Tel: (55-11) 212-5066
 Telex: 391-1131931 NSBR BR
 Fax: (55-11) 212-1181

National Semiconductor (Australia) Pty. Ltd.
 Building 16
 Business Park Drive
 Monash Business Park
 Nottingham, Melbourne
 Victoria 3168 Australia
 Tel: (3) 558-9999
 Fax: (3) 558-9998

National does not assume any responsibility for use of any circuitry described, no circuit patent licenses are implied and National reserves the right at any time without notice to change said circuitry and specifications.