



# Ultra-Low Power RS-485/RS-422 Transceiver with Low EMI and +/-10kV ESD Protection

## Preliminary Technical Data

## ADM1487

### FEATURES

- Low Power - 120 $\mu$ A Max ICC with Driver Disabled
- High Input Impedance — Up to 256 Transceivers on Bus
- Low-Current (1 $\mu$ A) Shutdown Mode
- Slew Rate Control for Error-Free Data Transmission and Low EMI
- $\pm$ 10kV ESD Protection (Human Body Model) on RS-485 I/O pins
- Thermal Protection of Driver
- Glitch-Free Driver Power-Up Allows Hot Connection
- Driver Maintains High Output Impedance with Power Off
- Wide Common-Mode Range Allows  $\pm$ 7V Ground Differences Between Devices
- Pin-Compatible with Industry Standard 75176

### APPLICATIONS

- Battery-Powered RS-485/RS-422 Systems
- Level Translation

### GENERAL DESCRIPTION

The ADM1487 is an ultra-low power RS-485/RS-422 transceiver consisting of one driver and one receiver per package. Quiescent operating current is typically 80 $\mu$ A and 1 $\mu$ A in shutdown mode. The driver and receiver both have three-state outputs. This allows multiple drivers to be connected to an RS-485/RS-422 bus, or several receiver outputs to be connected to a serial data bus. The driver will maintain a high-impedance output state even with power off, while the receiver features fail-safe operation that guarantees a logic high output if the inputs are left open-circuit.

The device has slew-rate limited drivers to minimize electromagnetic interference (EMI) and reduce reflections caused by incorrectly terminated cables.

### FUNCTIONAL BLOCK DIAGRAM

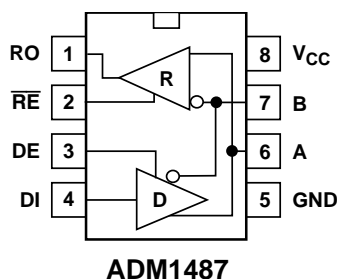

REV. PrC 08/02

Information furnished by Analog Devices is believed to be accurate and reliable. However, no responsibility is assumed by Analog Devices for its use, nor for any infringements of patents or other rights of third parties which may result from its use. No license is granted by implication or otherwise under any patent or patent rights of Analog Devices.

One Technology Way, P.O. Box 9106, Norwood, MA 02062-9106, U.S.A.  
Tel: 781/329-4700  
Fax: 781/326-8703  
www.analog.com  
Analog Devices, Inc., 2002

# PRELIMINARY TECHNICAL DATA

## ADM1487

# ADM1487 SPECIFICATIONS

DC ELECTRICAL CHARACTERISTICS ( $V_{CC} = +5V \pm 5\%$ ,  $T_A = 0^\circ C$  TO  $+70^\circ C$ , UNLESS OTHERWISE NOTED)

Parameter	Min	Typ	Max	Units	Test Conditions/Comments
Differential Driver Output Voltage, $V_{OD1}$			5	V	Unloaded, $I_O = 0$
Differential Driver Output Voltage, $V_{OD2}$	2.0 1.5		5	V V	Figure 1, $R = 50\Omega$ (RS-422) Figure 1, $R = 27\Omega$ (RS-485)
Change in Magnitude of Driver Differential Output Voltage for Complementary Output States, $\Delta V_{OD}$			0.2	V	Figure 1, $R = 27\Omega$ or $R = 50\Omega$
Driver Common-Mode Output Voltage, $V_{OC}$			3	V	Figure 1, $R = 27\Omega$ or $R = 50\Omega$
Change in Magnitude of Driver Common-Mode Output Voltage for Complementary Output States, $\Delta V_{OC} $			0.2	V	$R = 27\Omega$ or $R = 50\Omega$
Input High Voltage (DE, DI, $\overline{RE}$ ), $V_{IH}$	2			V	
Input Low Voltage (DE, DI, $\overline{RE}$ ), $V_{IL}$			0.8	V	
Input Current (DE, DI, $\overline{RE}$ ), $I_{IN1}$			$\pm 2$	$\mu A$	
Input Current (A, B), $I_{IN2}$			0.30 -0.15	mA mA	DE = 0, $V_{CC} = 0V$ or $5.25V$ , $V_{IN} = 12V$ DE = 0, $V_{CC} = 0V$ or $5.25V$ , $V_{IN} = -7V$
Differential Input Threshold Voltage for Receiver, $V_{TH}$	-0.2		0.2	V	$-7V \leq V_{CM} \leq 12V$
Receiver Input Hysteresis, $\Delta V_{TH}$		45		mV	$V_{CM} = 0V$
Receiver Output High Voltage, $V_{OH}$	3.5			V	$I_O = -4mA$ , $V_{ID} = 200mV$
Receiver Output Low Voltage, $V_{OL}$			0.4	V	$I_O = 4mA$ , $V_{ID} = -200mV$
Three-State (High Impedance) Output Current at Receive, $I_{OZR}$			$\pm 1$	$\mu A$	$V_{CC} = \text{Max}$ , $0.4V \leq V_O \leq 2.4V$
Receiver Input Resistance, $R_{IN}$	70	96		k $\Omega$	$-7V \leq V_{CM} \leq 12V$
Supply Current, $I_{CC}$		120 80	200 120	$\mu A$ $\mu A$	No Load, Output Enabled No Load, Output Disabled
Supply Current in Shutdown Mode, $I_{SHDN}$		1	10	$\mu A$	DE = 0V, $\overline{RE} = V_{CC}$
Driver Short-Circuit Current, $I_{OSD1}$	35		250	mA	$V_{OUT} = \text{HIGH}$ , $-7V \leq V_O \leq 12V$
Driver Short-Circuit Current, $I_{OSD2}$	35	250		mA	$V_{OUT} = \text{LOW}$ , $-7V \leq V_O \leq 12V$
Receiver Short-Circuit Current, $I_{OSR}$	7		85	mA	$0V \leq V_O \leq V_{OC}$

# ADM1487 SPECIFICATIONS (continued)

**ELECTRICAL CHARACTERISTICS** ( $V_{CC} = +5V \pm 5\%$ ,  $T_A = -40^\circ C$  TO  $+85^\circ C$ , UNLESS OTHERWISE NOTED)

Parameter	Min	Typ	Max	Units	Test Conditions/Comments
Differential Driver Output Voltage, $V_{OD1}$			5	V	Unloaded, $I_O = 0$
Differential Driver Output Voltage, $V_{OD2}$	2.0			V	Figure 1, $R = 50\Omega$ (RS-422)
	1.5		5	V	Figure 1, $R = 27\Omega$ (RS-485)
Driver Common-Mode Output Voltage, $V_{OC}$			3	V	Figure 1, $R = 27\Omega$ or $R = 50\Omega$
Differential Input Threshold Voltage for Receiver, $V_{TH}$	-0.2		0.2	V	$-7V \leq V_{CM} \leq 12V$
Receiver Input Hysteresis, $\Delta V_{TH}$		45		mV	$V_{CM} = 0V$
Supply Current, $I_{CC}$		120	200	$\mu A$	No Load, Output Enabled
		80	120	$\mu A$	No Load, Output Disabled
Supply Current in Shutdown Mode, $I_{SHDN}$		1	10	$\mu A$	$DE = 0V$ , $\overline{RE} = V_{CC}$
Driver Input to Output High, $t_{DPLH}$	150		1200	ns	Figures 2, 3, $R_{DIFF} = 54\Omega$ , $C_{L1} = C_{L2} = 100pF$
Driver Input to Output Low, $t_{DPHL}$	150		1200	ns	Figures 2, 3, $R_{DIFF} = 54\Omega$ , $C_{L1} = C_{L2} = 100pF$
Driver Output to Output, $t_{SKEW}$		100	600	ns	Figures 2, 3, $R_{DIFF} = 54\Omega$ , $C_{L1} = C_{L2} = 100pF$
Driver Rise or Fall Time, $t_{DR}$ , $t_{DF}$	150		2000	ns	Figures 2, 3, $R_{DIFF} = 54\Omega$ , $C_{L1} = C_{L2} = 100pF$
Receiver Input to Output High, $t_{RPLH}$	30	140	250	ns	Figures 2, 4, $R_{DIFF} = 54\Omega$ , $C_{L1} = C_{L2} = 100pF$
Receiver Input to Output Low, $t_{RHL}$	30	140	250	ns	Figures 2, 4, $R_{DIFF} = 54\Omega$ , $C_{L1} = C_{L2} = 100pF$
Differential Receiver Skew, $t_{SKD}$ $ t_{RPLH} - t_{RPHL} $		13		ns	Figures 2, 4, $R_{DIFF} = 54\Omega$ , $C_{L1} = C_{L2} = 100pF$
Maximum Data Rate, $f_{MAX}$	250			kbps	

**SWITCHING CHARACTERISTICS** ( $V_{CC} = +5V \pm 5\%$ ,  $T_A = -40^\circ C$  TO  $+85^\circ C$ , UNLESS OTHERWISE NOTED)

Parameter	Min	Typ	Max	Units	Test Conditions/Comments
Driver Input to Output High, $t_{DPLH}$	150		1200	ns	Figures 2, 3, $R_{DIFF} = 54\Omega$ , $C_{L1} = C_{L2} = 100pF$
Driver Input to Output, $t_{DPHL}$	150		1200	ns	Figures 2, 3, $R_{DIFF} = 54\Omega$ , $C_{L1} = C_{L2} = 100pF$
Driver Output to Output, $t_{SKEW}$		250	600	ns	Figures 2, 3, $R_{DIFF} = 54\Omega$ , $C_{L1} = C_{L2} = 100pF$
Driver Rise or Fall Time, $t_{DR}$ , $t_{DF}$	150		1200	ns	Figures 2, 3, $R_{DIFF} = 54\Omega$ , $C_{L1} = C_{L2} = 100pF$
Driver Enable to Output High, $t_{DZH}$	100		1500	ns	Figures 5, 6, $C_L = 100pF$ , S2 Closed
Driver Enable to Output Low, $t_{DZL}$	100		1500	ns	Figures 5, 6, $C_L = 100pF$ , S1 Closed
Driver Disable Time from Low, $t_{DLZ}$	150		1500	ns	Figures 5, 6, $C_L = 15pF$ , S1 Closed

## ADM1487

## ADM1487 SPECIFICATIONS (continued)

SWITCHING CHARACTERISTICS ( $V_{CC} = +5V \pm 5\%$ ,  $T_A = -40^\circ C$  TO  $+85^\circ C$ , UNLESS OTHERWISE NOTED)

Parameter	Min	Typ	Max	Units	Test Conditions/Comments
Driver Disable Time from High, $t_{DZH}$	150		1500	ns	Figures 5, 6, $C_L = 15pF$ , S2 Closed
Receiver Input to Output, $t_{RPLH}$	30	140	250	ns	Figures.2, 4, $R_{DIFF} = 54\Omega$ , $C_{L1} = C_{L2} = 100pF$
Receiver Input to Output Low, $t_{RPHL}$	30	140	250	ns	Figures.2, 4, $R_{DIFF} = 54\Omega$ , $C_{L1} = C_{L2} = 100pF$
Differential Receiver Skew, $t_{SKD}$ $ t_{PLH} - t_{PHL} $		13		ns	Figures.2, 4, $R_{DIFF} = 54\Omega$ , $C_{L1} = C_{L2} = 100pF$
Receiver Enable to Output Low, $t_{RZL}$		20	50	ns	Figures 7, 8, $C_{RL} = 15pF$ , S1 Closed
Receiver Enable to Output High, $t_{RZH}$		20	50	ns	Figures 7, 8, $C_{RL} = 15pF$ , S2 Closed
Receiver Disable from Low, $t_{RLZ}$		20	50	ns	Figures 7, 8, $C_{RL} = 15pF$ , S1 Closed
Receiver Disable from High, $t_{RHZ}$		20	50	ns	Figures 7, 8, $C_{RL} = 15pF$ , S2 Closed
Maximum Data Rate, $f_{MAX}$	250			kbps	
Time to Shutdown, $t_{SHDN}$	50	200	600	ns	DE = 0, $\overline{RE} =$ low to high transition
Driver Enable from Shutdown to Output High, $t_{DZH(SHDN)}$			2000	ns	Figures 5, 6, $C_L = 100pF$ , S2 Closed
Driver Enable from Shutdown to Output Low, $t_{DZL(SHDN)}$			2000	ns	Figures 5, 6, $C_L = 100pF$ , S1 Closed
Receiver Enable from Shutdown to Output High, $t_{RZH(SHDN)}$			2000	ns	Figures 7, 8, $C_L = 15pF$ , S2 Closed
Receiver Enable from Shutdown to Output Low, $t_{RZL(SHDN)}$			2000	ns	Figures 7, 8, $C_L = 15pF$ , S1 Closed

## NOTES

<sup>1</sup>Absolute maximum ratings are those beyond which the safety of the device cannot be guaranteed.<sup>2</sup>All currents into device pins are positive; all currents out of device pins are negative. All voltages are referenced to device ground unless otherwise specified.<sup>3</sup>All typicals are given for  $V_{CC} = 5V$  and  $T_p = 25^\circ C$ .<sup>4</sup>The ADM1487 is not tested and is not quality-assurance sampled at  $-40^\circ C$  and at  $85^\circ C$ . These specifications are guaranteed by design, correlation, and/or inference from  $0^\circ C$ ,  $25^\circ C$  and/or  $70^\circ C$  tests.

## ABSOLUTE MAXIMUM RATINGS

Supply Voltage ( $V_{CC}$ )	12V
Control Input Voltage	$-0.5V$ to $V_{CC} + 0.5V$
Driver Input Voltage	$-0.5V$ to $V_{CC} + 0.5V$
Driver Output Voltage	$\pm 14V$
Receiver Input Voltage	$\pm 14V$
Receiver Output Voltage	$-0.5V$ to $V_{CC} + 0.5V$
Operating Temperature Range	$0^\circ C \leq T_A \leq 70^\circ C$
Lead Temperature (Soldering, 10 sec)	$300^\circ C$

\*Stresses above those listed under "Absolute Maximum Ratings" may cause permanent damage to the device. This is a stress rating only; functional operation of the device at these or any other conditions above those indicated in the operational section of this specification is not implied. Exposure to absolute maximum rating conditions for extended periods may affect device reliability.

## THERMAL CHARACTERISTICS

8-Pin Plastic DIP Package

 $\theta_{JA} =$  tbd K/Watt,  $\theta_{JC} =$  tbd K/Watt

8-Pin Plastic SO Package

 $\theta_{JA} =$  tbd K/Watt,  $\theta_{JC} =$  tbd K/Watt

## PIN CONFIGURATION

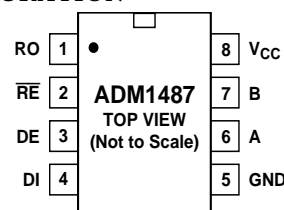

## ORDERING INFORMATION

Model	Temperature Range	Package Option
ADM1487JN	$0^\circ C$ to $+70^\circ C$	8 Pin Plastic DIP
ADM1487JR	$0^\circ C$ to $+70^\circ C$	8 Pin SO
ADM1487AN	$-40^\circ C$ to $+85^\circ C$	8 Pin Plastic DIP
ADM1487AR	$-40^\circ C$ to $+85^\circ C$	8 Pin SO



ADM1487

# ADM1487 TYPICAL PERFORMANCE CHARACTERISTICS

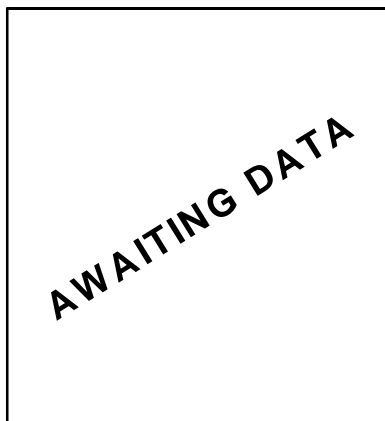

TPC1. No-load Supply Current vs. Temperature

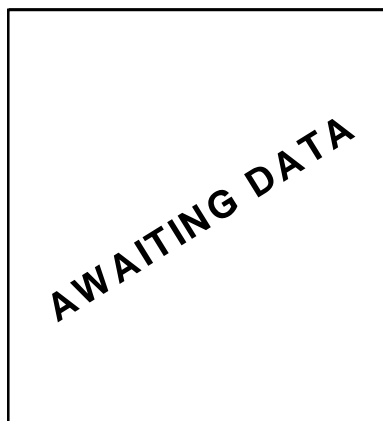

TPC2. Output Current vs. Receiver Output High Voltage

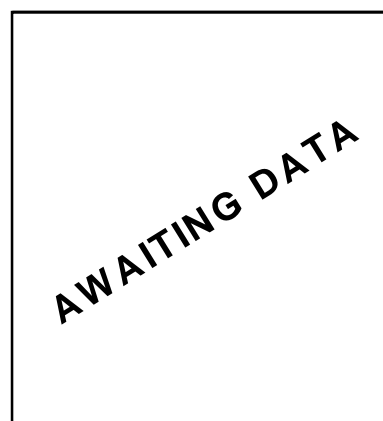

TPC3. Output Current vs. Receiver Output Low Voltage

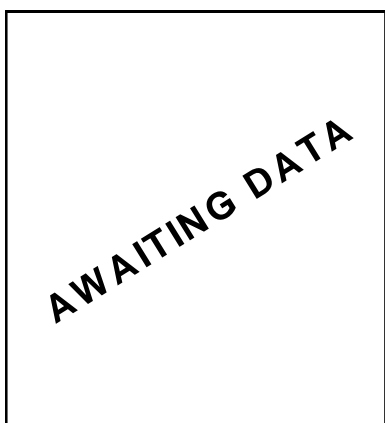

TPC4. Receiver Output High Voltage vs. Temperature

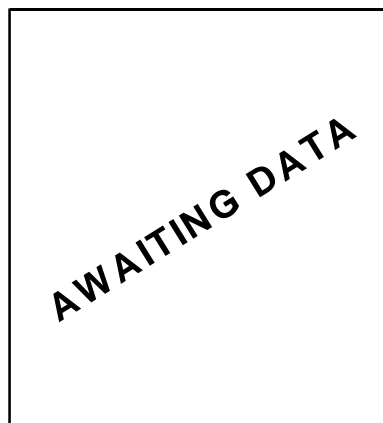

TPC5. Receiver Output Low Voltage vs. Temperature

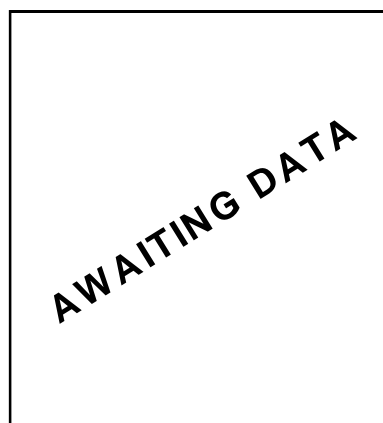

TPC6. Shutdown Current vs. Temperature

## PIN FUNCTION DESCRIPTION

Pin	Mnemonic	Description
1	RO	Receiver Output. When $\overline{RE}$ is low and $A - B \geq$ (more positive than) 200mV, RO will be high. When $\overline{RE}$ is low and $A - B \leq$ (more negative than) -200mV, RO will be low.
2	$\overline{RE}$	Receiver Output Enable. Take $\overline{RE}$ low to enable RO; RO is high impedance when $\overline{RE}$ is high. Take $\overline{RE}$ high and DE low to enter low-power shutdown mode.
3	DE	Driver Output Enable. Take DE high to enable driver outputs. These outputs are high impedance when DE is low. Take RE high and DE low to enter low-power shutdown mode.
4	DI	Driver Input. With DE high, a low on DI forces non-inverting output low and inverting output high. Similarly, a high on DI forces non-inverting output high and inverting output low.
5	GND	Ground
6	A	Non-Inverting Receiver Input and Non-Inverting Driver Output
7	B	Inverting Receiver Input and Inverting Driver Output
8	V <sub>CC</sub>	Positive Supply 4.75V =V <sub>CC</sub> =5.25V

## DEVICE TRUTH TABLES

## TRANSMITTING

INPUTS			OUTPUTS	
$\overline{RE}$	DE	DI	Z	Y
X	1	1	0	1
X	1	0	1	0
0	0	X	High-Z	High-Z
1	0	X	Shutdown*	

X = Don't care

## CIRCUIT DESCRIPTION

The ADM1487 is a differential input, differential output transceiver designed RS-485/RS-422 serial data communications over twisted-pair cables. It is a half-duplex device intended for alternate transmission and reception of data over a single twisted-pair cable, and the driver outputs and receiver inputs are internally linked and brought out to a single pair of pins.

Its principal features include ultra-low power operation, a controlled slew-rate driver that minimizes electromagnetic interference (EMI) and signals reflections due to incorrectly terminated lines, and high input impedance that allows up to 256 receivers to be connected to a bus.

## THREE-STATE BUS CONNECTION

The ADM1487 has a Driver Enable pin (DE) that enables the driver outputs when taken high or puts the driver outputs into a high-impedance state when taken low. This allows several driver outputs to be connected to an RS-422/RS-485 bus.

Similarly, the device has a (active-low) Receiver Enable pin ( $\overline{RE}$ ). Taking this low enables the receiver, while taking it high puts the receiver outputs into a high-impedance state. This allows several receiver outputs to be connected to a serial data bus.

The input impedance of the device is 96k $\Omega$ , which is 8 times higher than the standard RS-485 load of 12k $\Omega$ . A standard driver can driver 32 standard loads, so up to 256 ADM1487 receivers, or a combination of ADM1487 and other devices up to 32 unit loads, may be connected to an RS-422/RS485 bus driven by a single driver.

## LOW POWER OPERATION

The ADM1487 draws very little supply current (typically 80 $\mu$ A) when the driver outputs are disabled or unloaded. This will increase by up to 72 $\mu$ A if the driver outputs are enabled (but unloaded) and applying the maximum output swing of 5V across the receiver input resistors.

However, in practical applications with the device driving and RS-485/RS422 cable or bus, the current drain is dominated by the current sourced into the line termination resistors and any other devices on the bus. With a half-termination (120 $\Omega$  load) between the driver outputs, the load current can be in excess of 13mA as the drivers force a minimum of 1.5V across the line, and can be greater than 25mA with a fully terminated 60 $\Omega$  line attached.

## RECEIVING

INPUTS			OUTPUT
$\overline{RE}$	DE	A-B	RO
0	X	$\geq 0.2V$	1
0	X	$\leq -0.2V$	0
0	X	Open/shorted	1
1	0	X	Shutdown*

\*In shutdown mode, driver and receiver outputs high impedance

## SHUTDOWN MODE

If  $\overline{RE}$  is taken high while DE is taken low, the device will enter a low-power shutdown mode, in which the supply current is typically 1 $\mu$ A.

If the driver outputs are active immediately before shutdown (DE high), the supply current will not drop to 1 $\mu$  until the driver outputs have settled to their three-state mode, which can take up to 2.6 $\mu$ s worst-case. If DE is already low and shutdown is entered by taking  $\overline{RE}$  high, the supply current will drop to 1 $\mu$ A very quickly.

When  $\overline{RE}$  is taken low and/or DE is taken high, the device will wake up within 3.5 $\mu$ s.

If shutdown mode is not used, the fact that DE is active-high and  $\overline{RE}$  is active-low offers a convenient way of switching the device between transmit and receive, by tying DE and  $\overline{RE}$  together. This is useful, for example, in applications using half duplex operation and where several receiver outputs are connected to a serial bus.

The device is guaranteed not to enter shutdown mode if DE and  $\overline{RE}$  are driven in this way. If DE is low and  $\overline{RE}$  is high for less than 50ns the device will not enter shutdown. If DE is low and  $\overline{RE}$  is high for greater than 600ns, the device is guaranteed to enter shutdown.

## RECEIVER INPUTS

The ADM1487 receiver has an input common-mode range covering the entire RS-485 range of -7V to 12V. Internal 96k $\Omega$  input resistors from each line terminal to ground provide a 1/8 unit load to the RS485 bus.

Differential signals greater than  $\pm 200mV$  within the specified input common-mode range are converted to a TTL-compatible logic signal at the receiver output. A small amount of input hysteresis is included to minimize the effects of noise on the line signals. If the line is terminated or the receiver inputs are shorted together, the receiver output will retain the last valid line signal due to the 45mV of hysteresis incorporated in the receiver circuit. If the receiver inputs are left floating (unterminated), an internal pull-up of 10 $\mu$ A at the A input will force the receiver output to a guaranteed high output state.

## DRIVER OUTPUT STAGE

The RS-485 specification requires that a transceiver withstand common-mode voltages of up to 12V above or -7V below system ground at the RS-485 line connections.

In addition, the transceiver must be protected against both ESD and latch-up. This precludes the use of conventional

# ADM1487

CMOS output stages, which include parasitic diodes from their driver outputs to each supply rail and can latch up when these diodes conduct.

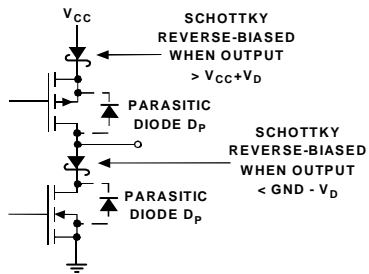

Figure 9. ADM1487 Driver Output Stage

The ADM1487 output includes Schottky diodes in series with the positive supply to the drain of the P-channel output device and in series with the drain of the N-channel output device. These diodes prevent the P-channel's parasitic diode from conducting when the output voltage exceeds  $V_{CC}$  and prevent the N-channel's parasitic diode from conducting when the output voltage falls below ground.

## SLEW RATE CONTROL

The driver output stage of the ADM1487 has a controlled slew rate to minimize signal reflections on incorrectly terminated lines and to reduce electromagnetic interference (EMI).

## CURRENT LIMIT AND THERMAL SHUTDOWN

The ADM1487 incorporates two protection mechanisms to guard the drivers against short-circuits, bus contention or other fault conditions. The first is a current-limited output stage that protects the driver against short-circuits over the entire common-mode voltage range by limiting the output current to about 70mA. Under extreme fault conditions where the current limit is not effective, a thermal shutdown circuit puts the driver outputs into a high-impedance state if the die temperature exceeds  $150^{\circ}\text{C}$ , and does not turn them back on until the temperature has fallen to  $130^{\circ}\text{C}$ .

## ENHANCED ESD PROTECTION

All Analog Devices parts incorporate protection against electrostatic discharge (ESD) to protect the devices during handling, assembly and normal operation. In addition, the ADM1487 has enhanced ESD protection up to  $\pm 10\text{kV}$  on the A and B I/O pins to protect against severe operational conditions such as line transients, connection and disconnection.

## APPLICATION INFORMATION

Figure 10 shows a typical application of the ADM1487. This is a half-duplex RS-485/RS-422 network. Up to 254 additional ADM1487s can be connected along the cable (termination resistors are only required at each end).

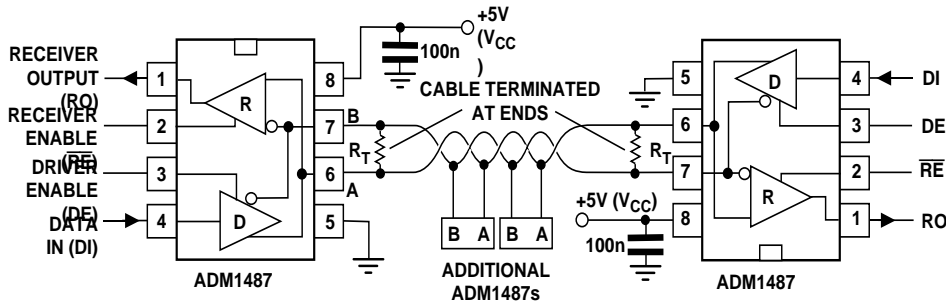
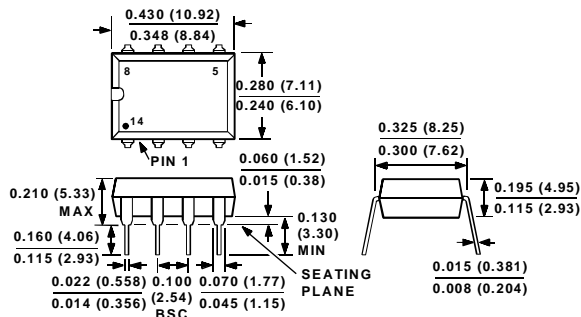

Figure 10. Typical Half-Duplex RS-485/RS-422 Network

## OUTLINE DIMENSIONS

Dimensions shown in inches and (mm).

### 8-Pin Plastic Dual-In-Line Package (N-8)



### 8-Pin SO Package (R-8)

