

Dual N-Channel 30-V (D-S) MOSFET

■ Features

- Low $r_{DS(on)}$ Provides Higher Efficiency and Extends Battery Life
- Miniature SO-8 Surface Mount Package Saves Board Space
- High power and current handling capability
- Low side high current DC-DC Converter applications

■ General Description

These miniature surface mount MOSFETs utilize High Cell Density process. Low $r_{DS(on)}$ assures minimal power loss and conserves energy, making this device ideal for use in power management circuitry. Typical applications are PWM DC-DC converters, power management in portable and battery-powered products such as computers, printers, battery charger, telecommunication power system, and telephones power system.

■ Product Summary

V_{DS} (V)	$r_{DS(on)}$ (m Ω)	I_D (A)
30	13.5@ $V_{GS}=10V$	10
	20@ $V_{GS}=4.5V$	8

■ Pin Assignments

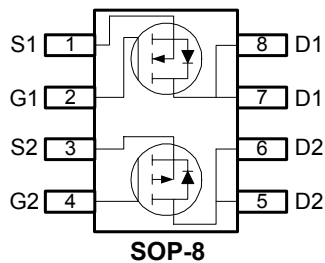

■ Pin Descriptions

Pin Name	Description
S1/2	Channel 1/2 Source
G1/2	Channel 1/2 Gate
D1/2	Channel 1/2 Drain

■ Ordering information

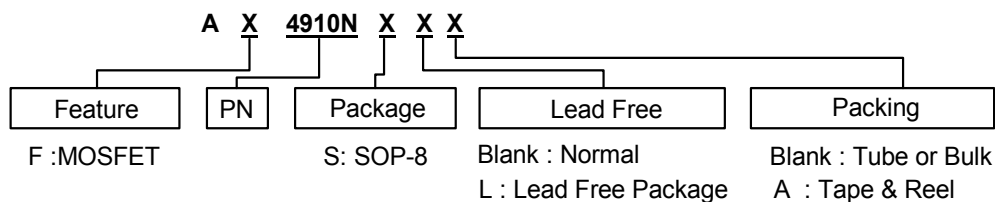



Dual N-Channel 30-V (D-S) MOSFET

Absolute Maximum Ratings ($T_A=25^\circ\text{C}$ unless otherwise noted)

Symbol	Parameter	Rating	Units
V_{DS}	Drain-Source Voltage	30	V
V_{GS}	Gate-Source Voltage	± 20	V
I_D	Continuous Drain Current (Note 1)	$T_A=25^\circ\text{C}$	10
		$T_A=70^\circ\text{C}$	8.2
I_{DM}	Pulsed Drain Current (Note 2)	± 50	A
I_S	Continuous Source Current (Diode Conduction) (Note 1)	2.3	A
P_D	Power Dissipation (Note 1)	$T_A=25^\circ\text{C}$	2.1
		$T_A=70^\circ\text{C}$	1.3
T_J, T_{STG}	Operating Junction and Storage Temperature Range	-55 to 150	$^\circ\text{C}$

Thermal Resistance Ratings

Symbol	Parameter	Maximum	Units
$R_{\theta JC}$	Maximum Junction-to-Case (Note 1)	40	$^\circ\text{C/W}$
$R_{\theta JA}$	Maximum Junction-to-Ambient (Note 1)	60	$^\circ\text{C/W}$

Note 1: surface Mounted on 1"x1" FR4 Board.

Note 2: Pulse width limited by maximum junction temperature

Specifications ($T_A=25^\circ\text{C}$ unless otherwise noted)

Symbol	Parameter	Test Conditions	Limits			Unit
			Min.	Typ.	Max.	
Static						
$V_{(BR)DSS}$	Drain-Source breakdown Voltage	$V_{GS}=0V, I_D=250\mu\text{A}$	30	-	-	V
$V_{GS(th)}$	Gate-Threshold Voltage	$V_{DS}=V_{GS}, I_D=250\mu\text{A}$	1	1.95	3.0	V
I_{GSS}	Gate-Body Leakage	$V_{DS}=0V, V_{GS}=20V$	-	-	± 100	nA
I_{DSS}	Zero Gate Voltage Drain Current	$V_{DS}=24V, V_{GS}=0V$	-	-	1	uA
		$V_{DS}=24V, V_{GS}=0V, T_J=55^\circ\text{C}$	-	-	25	
$I_{D(on)}$	On-State Drain Current (Note 3)	$V_{DS}=5V, V_{GS}=10V$	20	-	-	A
$r_{DS(on)}$	Drain-Source On-Resistance (Note 3)	$V_{GS}=10V, I_D=10A$	-	11	13.5	m Ω
		$V_{GS}=4.5V, I_D=8A$	-	15	20	
		$V_{GS}=10V, I_D=15A, T_J=55^\circ\text{C}$	-	12.5	15	
g_{fs}	Forward Transconductance (Note 3)	$V_{DS}=15V, I_D=10A$	-	40	-	S
V_{SD}	Diode Forward Voltage	$I_S=2.3A, V_{GS}=0V$	-	0.7	1.1	V
Dynamic (Note 4)						
Q_g	Total Gate Charge	$V_{DS}=15V, V_{GS}=5V, I_D=10A$	-	20	34	nC
Q_{gs}	Gate-Source Charge		-	7.0	-	
Q_{gd}	Gate-Drain Charge		-	7.0	-	
Switching						
$t_{d(on)}$	Turn-On Delay Time	$V_{DD}=25, R_L=25\Omega, I_D=1A, V_{GEN}=10V$	-	20	30	nS
t_r	Rise Time		-	9	20	
$t_{d(off)}$	Turn-Off Delay Time		-	70	102	
t_f	Fall-Time		-	20	81	
t_{rr}	Source-Drain Reverse Recovery Time		$I_F=2.3A, DI/Dt=100A/\mu\text{s}$	-	41	

Note 3: Pulse test: $PW \leq 300\mu\text{s}$ duty cycle $\leq 2\%$.

Note 4: Guaranteed by design, not subject to production testing.

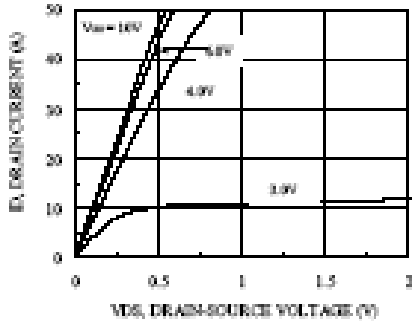
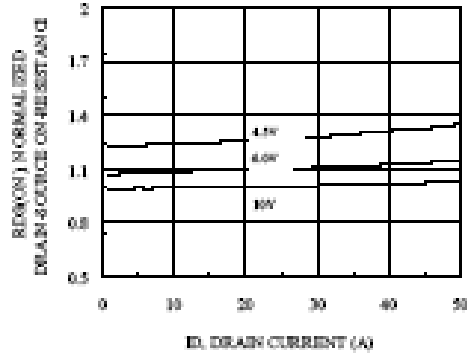
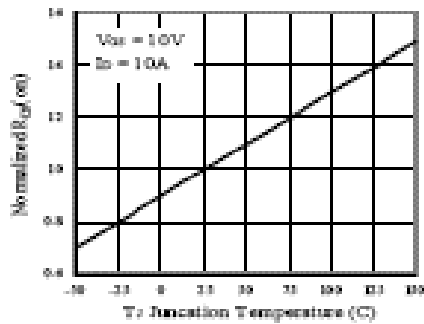
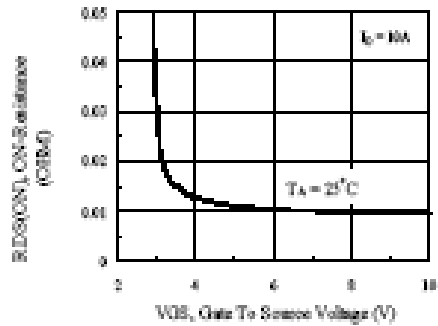
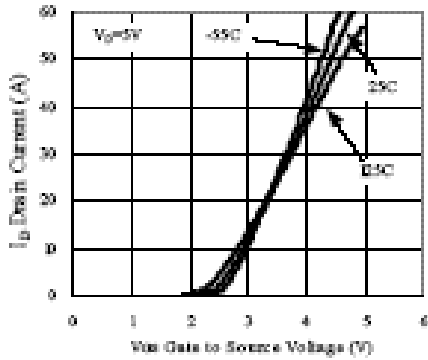
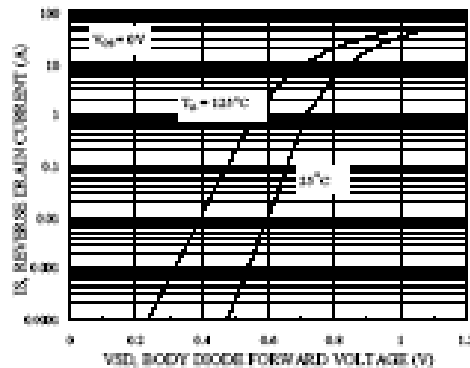
Dual N-Channel 30-V (D-S) MOSFET
■ Typical Performance Characteristics
Typical Electrical Characteristics (N-Channel)

Figure 1. On-Region Characteristics

Figure 2. On-Resistance with Drain Current

Figure 3. On-Resistance Variation with Temperature

Figure 4. On-Resistance Variation with Gate to Source Voltage

Figure 5. Transfer Characteristics

Figure 6. Body Diode Forward Voltage Variation with Source Current and Temperature

Dual N-Channel 30-V (D-S) MOSFET

■ Typical Performance Characteristics

Typical Electrical Characteristics (N-Channel)

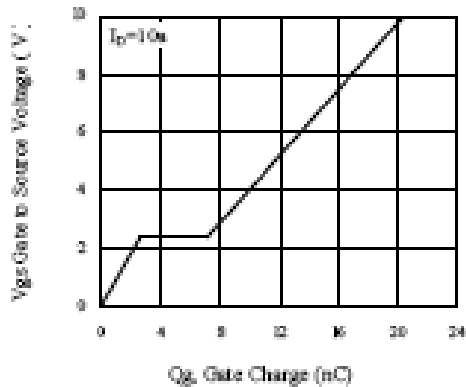

Figure 7. Gate Charge Characteristics

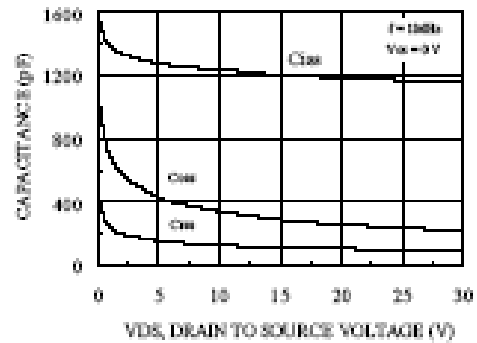

Figure 8. Capacitance Characteristics

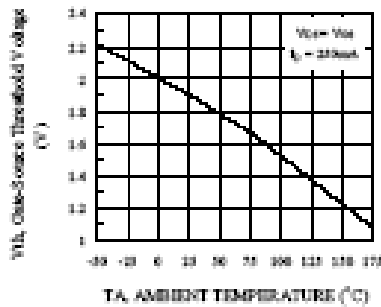

Figure 9. Threshold V_t vs Ambient Temperature

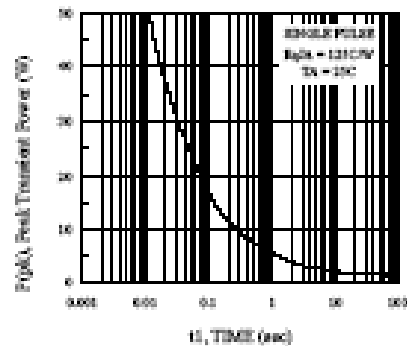

Figure 10. Single Pulse Maximum Power Dissipation

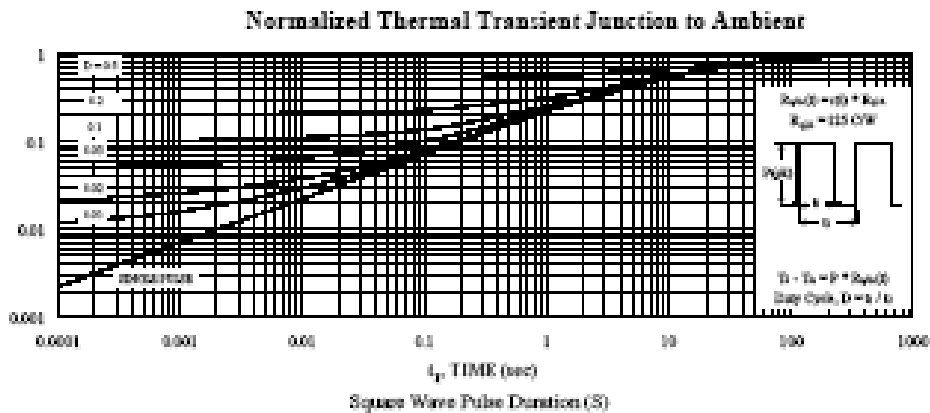
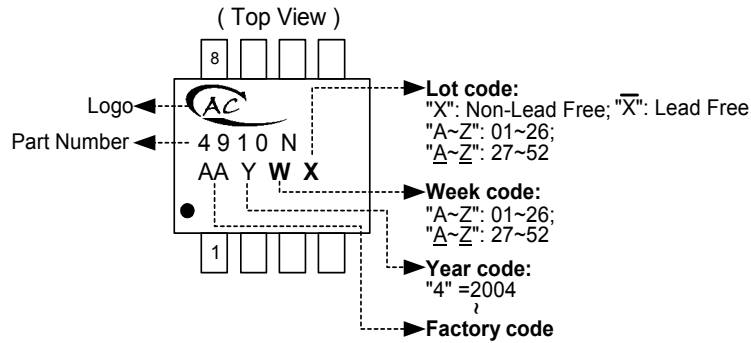

Figure 11. Transient Thermal Response Curve

Dual N-Channel 30-V (D-S) MOSFET

■ Marking Information

SOP-8L



■ Package Information

Package Type: SOP-8L

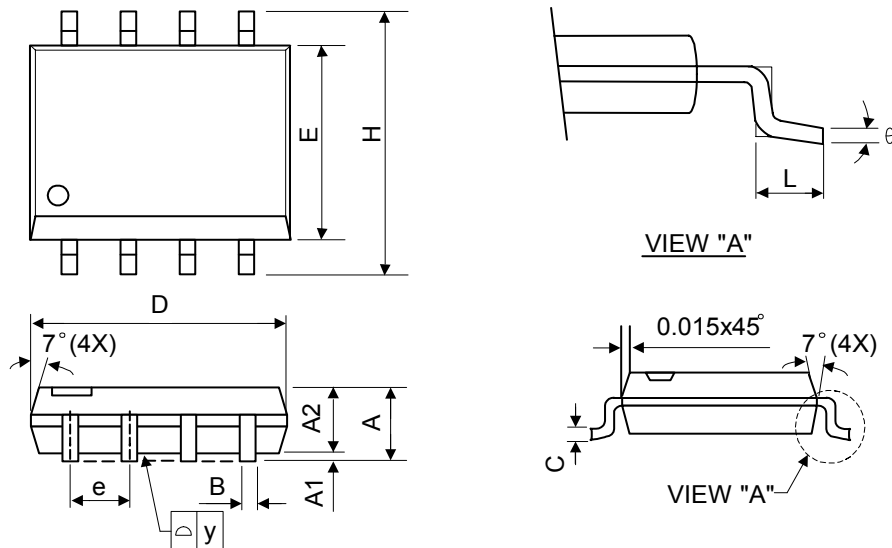

Symbol	Dimensions In Millimeters			Dimensions In Inches		
	Min.	Nom.	Max.	Min.	Nom.	Max.
A	1.40	1.60	1.75	0.055	0.063	0.069
A1	0.10	-	0.25	0.040	-	0.100
A2	1.30	1.45	1.50	0.051	0.057	0.059
B	0.33	0.41	0.51	0.013	0.016	0.020
C	0.19	0.20	0.25	0.0075	0.008	0.010
D	4.80	5.05	5.30	0.189	0.199	0.209
E	3.70	3.90	4.10	0.146	0.154	0.161
e	-	1.27	-	-	0.050	-
H	5.79	5.99	6.20	0.228	0.236	0.244
L	0.38	0.71	1.27	0.015	0.028	0.050
y	-	-	0.10	-	-	0.004
θ	0°	-	8°	0°	-	8°