

FEATURES

• **Compact slim body saves space**

Thanks to the small surface area of 5.7 mm × 10.6 mm .224 inch × .417 inch and low height of 9.0 mm .354 inch, the packaging density can be increased to allow for much smaller designs.

• **Outstanding surge resistance.**

Surge withstand between open contacts: 1,500 V 10×160 μs (FCC part 68)
Surge withstand between contacts and coil: 2,500 V 2×10 μs (Bellcore)

• **The use of twin crossbar contacts ensures high contact reliability.**

AgPd contact is used because of its good sulfide resistance. Adopting low-gas molding material. Coil assembly molding technology which avoids generating volatile gas from coil.

• **Increased packaging density**

Due to highly efficient magnetic circuit design, leakage flux is reduced and changes in electrical characteristics from components being mounted close-together are minimized. This all means a packaging density higher than ever before.

• **Nominal operating power: 140 mW**

• **Outstanding vibration and shock resistance.**

Functional shock resistance: 750 m/s² {75G}

Destructive shock resistance: 1,000 m/s² {100G}

Functional vibration resistance: 10 to 55 Hz (at double amplitude of 3.3 mm .130 inch)

Destructive vibration resistance: 10 to 55 Hz (at double amplitude of 5 mm .197 inch)

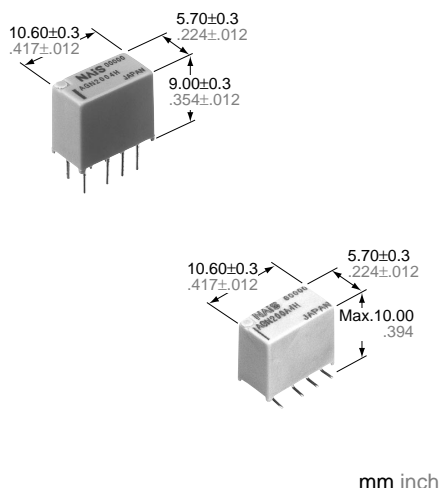

SPECIFICATIONS

Contact

Arrangement	2 Form C	
Initial contact resistance, max. (By voltage drop 6 V DC 1 A)	100 mΩ	
Contact material	Stationary: AgPd+Au clad Movable: AgPd	
Rating	Nominal switching capacity (resistive load)	1 A 30 V DC 0.3 A 125 V AC
	Max. switching power (resistive load)	30 W, 37.5 V A
	Max. switching voltage	110 V DC, 125 V AC
	Max. switching current	1 A
	Min. switching capacity *1	10 μA 10 mV DC
Nominal operating power	Single side stable	140mW (1.5 to 12 V DC) 230mW (24 V DC)
	1 coil latching	100mW (1.5 to 12 V DC) 120mW (24 V DC)
Expected life (min. operations)	Mechanical (at 180 cpm)	5 × 10 ⁷
	Electrical (at 20 cpm)	1 A 30 V DC resistive
		0.3 A 125 V AC resistive

Remarks:

- * Specifications will vary with foreign standards certification ratings.
- *1 Measurement at same location as "Initial breakdown voltage" section.
- *2 Detection current: 10mA.
- *3 Nominal voltage applied to the coil, excluding contact bounce time.
- *4 By resistive method, nominal voltage applied to the coil; contact carrying current: 1 A.
- *5 Half-wave pulse of sine wave: 6 ms; detection time: 10μs.
- *6 Half-wave pulse of sine wave: 6 ms.
- *7 Detection time: 10μs.
- *8 Refer to 5. Conditions for operation, transport and storage mentioned in AMBIENT ENVIRONMENT (Page 61)

Characteristics

Initial insulation resistance*1		Min. 1,000MΩ (at 500V DC)
Initial breakdown voltage*2	Between open contacts	750 Vrms for 1min.
	Between contact sets	1,000 Vrms for 1min.
Initial surge voltage	Between contacts and coil	1,500 Vrms for 1min.
	Between open contacts (10×160 μs)	1,500 V (FCC Part 68)
	Between contacts and coil (2×10 μs)	2,500 V (Bellcore)
Operate time [Set time]*3 (at 20°C)		Max. 4 ms (Approx. 2 ms) [Max. 4 ms (Approx. 2 ms)]
Release time (without diode) [Reset time]*3 (at 20°C)		Max. 4 ms (Approx. 1 ms) [Max. 4 ms (Approx. 2 ms)]
Temperature rise*4 (at 20°C)		Max. 50°C
Shock resistance	Functional*5	Min. 750 m/s ² {75G}
	Destructive*6	Min. 1,000 m/s ² {100G}
Vibration resistance	Functional*7	10 to 55 Hz at double amplitude of 3.3 mm
	Destructive	10 to 55 Hz at double amplitude of 5 mm
Conditions for operation, transport and storage*8 (Not freezing and condensing at low temperature)	Ambient temperature *2	-40°C to 85°C -40°F to 185°F
	Humidity	5 to 85% R.H.
Unit weight		Approx. 1 g.035 oz

Notes:

- *1 This value can change due to the switching frequency, environmental conditions, and desired reliability level, therefore it is recommended to check this with the actual load.
- *2 The upper limit for the ambient temperature is the maximum temperature that can satisfy the coil temperature rise. Under the packing condition, allowable temperature range is from -40 to +70°C -40° to +158°F.

TYPICAL APPLICATIONS

- Telephone exchange, transmission equipment
- Communications devices
- Measurement devices
- Home appliances, and audio/visual equipment
- Handheld and portable products

ORDERING INFORMATION

Ex. AGN 2 0 0 A 1 H Z

Contact arrangement	Operating function	Type of operation	Terminal shape	Coil voltage (DC)	Packing style
2: 2 Form C	0: Single side stable 1: 1 coil latching	0: Standard type (B.B.M.)	Nil: Standard PC board terminal A: Surface-mount terminal A type S: Surface-mount terminal S type	1H: 1.5V 09: 9V 03: 3V 12: 12V 4H: 4.5V 24: 24V 06: 6V	Nil: Tube packing Z: Tape and reel packing (piked from 5/6/7/8 pin side)

Note: Tape and reel packing symbol "Z" is not marked on the relay. "X" type tape and reel packing (piked from 1/2/3/4-pin side) is also available. Suffix "X" instead of "Z".

TYPES AND COIL DATA (at 20°C 68°F)

(1) Standard PC board terminal

Operating Function	Part No.	Coil Rating, V DC	Pick-up voltage, V DC (max.) (initial)	Drop-out voltage, V DC (min.) (initial)	Nominal operating current, mA (±10%)	Coil resistance, Ω (±10%)	Nominal operating power, mW	Max. allowable voltage, V DC
	Standard PC board terminal							
Single side stable	AGN2001H	1.5	1.13	0.15	93.8	16	140	2.25
	AGN20003	3	2.25	0.3	46.7	64.2	140	4.5
	AGN2004H	4.5	3.38	0.45	31	145	140	6.75
	AGN20006	6	4.5	0.6	23.3	257	140	9
	AGN20009	9	6.75	0.9	15.5	579	140	13.5
	AGN20012	12	9	1.2	11.7	1,028	140	18
	AGN20024	24	18	2.4	9.6	2,504	230	28.8
Operating Function	Part No.	Coil Rating, V DC	Set voltage, V DC (max.) (initial)	Reset voltage, V DC (max.) (initial)	Nominal operating current, mA (±10%)	Coil resistance, Ω (±10%)	Nominal operating power, mW	Max. allowable voltage, V DC
	Standard PC board terminal							
1 coil latching	AGN2101H	1.5	1.13	1.13	66.7	22.5	100	2.25
	AGN21003	3	2.25	2.25	33.3	90	100	4.5
	AGN2104H	4.5	3.38	3.38	22.2	202.5	100	6.75
	AGN21006	6	4.5	4.5	16.7	360	100	9
	AGN21009	9	6.75	6.75	11.1	810	100	13.5
	AGN21012	12	9	9	8.3	1,440	100	18
	AGN21024	24	18	18	5.0	4,800	120	36

1) Standard packing: 50 pcs. in an inner package (tube); 1,000 pcs. in an outer package

2) Specified value of pick-up, drop-out, set and reset voltage is with the condition of square wave coil pulse.

(2) Surface-mount terminal

Operating Function	Part No.		Coil Rating, V DC	Pick-up voltage, V DC (max.) (initial)	Drop-out voltage, V DC (min.) (initial)	Nominal operating current, mA (±10%)	Coil resistance, Ω (±10%)	Nominal operating power, mW	Max. allowable voltage, V DC
	Tube packing	Tape and reel packing							
Single side stable	AGN200○1H	AGN200○1HZ	1.5	1.13	0.15	93.8	16	140	2.25
	AGN200○03	AGN200○03Z	3	2.25	0.3	46.7	64.2	140	4.5
	AGN200○4H	AGN200○4HZ	4.5	3.38	0.45	31	145	140	6.75
	AGN200○06	AGN200○06Z	6	4.5	0.6	23.3	257	140	9
	AGN200○09	AGN200○09Z	9	6.75	0.9	15.5	579	140	13.5
	AGN200○12	AGN200○12Z	12	9	1.2	11.7	1,028	140	18
	AGN200○24	AGN200○24Z	24	18	2.4	9.6	2,504	230	28.8

○: For each surface-mounted terminal variation, input the following letter.

A type: A, S type: S

1) Standard packing: 50 pcs.(tube), 500pcs. (tape and reel)in an inner package; 1,000 pcs. in an outer package

2) Specified value of pick-up, drop-out, set and reset voltage is with the condition of square wave coil pulse.

Operating Function	Part No.		Coil Rating, V DC	Set voltage, V DC (max.) (initial)	Reset voltage, V DC (max.) (initial)	Nominal operating current, mA (±10%)	Coil resistance, Ω (±10%)	Nominal operating power, mW	Max. allowable voltage, V DC
	Tube packing	Tape and reel packing							
1 coil latching	AGN210○1H	AGN210○1HZ	1.5	1.13	1.13	66.7	22.5	100	2.25
	AGN210○03	AGN210○03Z	3	2.25	2.25	33.3	90	100	4.5
	AGN210○04H	AGN210○04HZ	4.5	3.38	3.38	22.2	202.5	100	6.75
	AGN210○06	AGN210○06Z	6	4.5	4.5	16.7	360	100	9
	AGN210○09	AGN210○09Z	9	6.75	6.75	11.1	810	100	13.5
	AGN210○12	AGN210○12Z	12	9	9	8.3	1,440	100	18
	AGN210○24	AGN210○24Z	24	18	18	5.0	4,800	120	36

○: For each surface-mounted terminal variation, input the following letter.

A type: **A**, S type: **S**

- 1) Standard packing: 50 pcs.(tube), 500pcs. (tape and reel)in an inner package; 1,000 pcs. in an outer package
- 2) Specified value of pick-up, drop-out, set and reset voltage is with the condition of square wave coil pulse.

DIMENSIONS

mm inch

1. PC board terminal

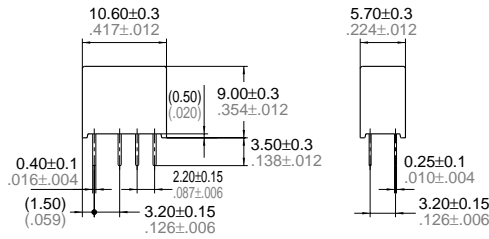

PC board pattern

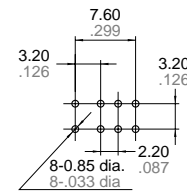

Tolerance: ±0.1 ±.004

Schematic (Bottom view)

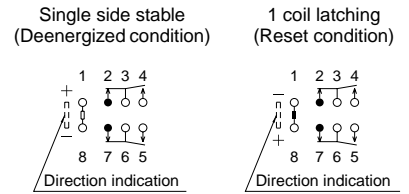

2. Surface-mount terminal

1) A type

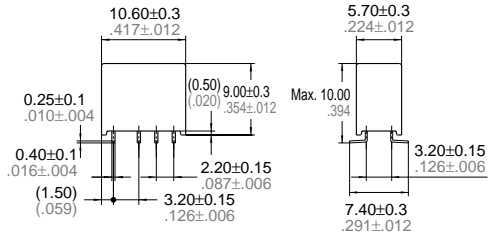
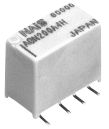

Suggested mounting pad

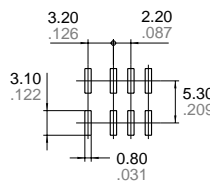

Tolerance: ±0.1 ±.004

Schematic (Top view)

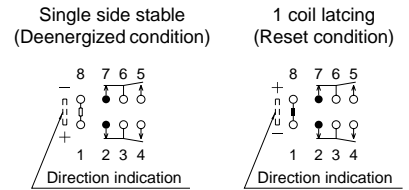

1) S type

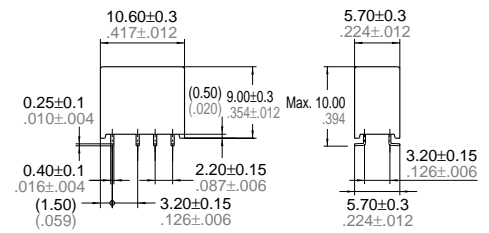
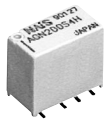

Suggested mounting pad

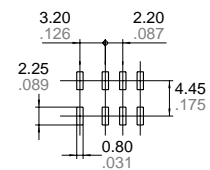

Tolerance: ±0.1 ±.004

REFERENCE DATA

1. Max. switching capacity

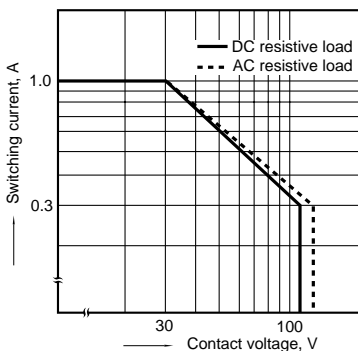

2. Life curve

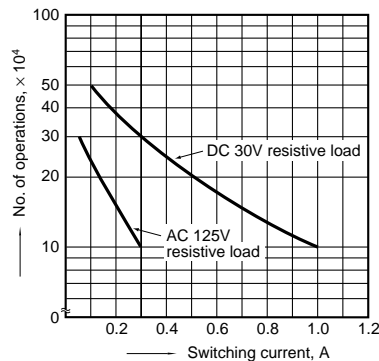

NOTES

1. Coil operating power

- As a general rule, only a pure DC power supply should be used for the coil drive.
- To ensure proper operation, the voltage applied to both terminals of the coil should be $\pm 5\%$ (at 20°C 68°F) the rated operating voltage of the coil. Also, be aware that the pick-up and drop-out voltages will fluctuate depending on the ambient temperature and operating conditions.
- The ripple factor for the voltage applied to the coil should be less than 5%.
- For set and reset latching relays, the rated operating voltage should be applied to the coil for 10 ms or more.

2. Coil connection

When connecting coils, refer to the wiring diagram to prevent mis-operation or malfunction.

3. External magnetic field

Since GN relays are highly sensitive polarized relays, their characteristics will be affected by a strong external magnetic field. Avoid using the relay under that conditions.

4. Cleaning

In automatic cleaning, cleaning with the boiling method is recommended. Avoid ultrasonic cleaning which subjects the relay to high frequency vibrations. It may cause the contacts to stick.

It is recommended that a fluorinated hydrocarbon or other alcoholic solvent be used.

5. Packing style

- The relay is packed in a tube with the relay orientation mark on the left side, as shown in the figure below.

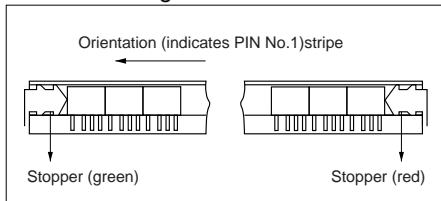

2) Tape and reel packing

(A type)

(1)-1 Tape dimensions

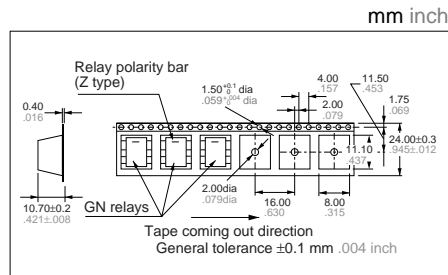

(S type)

(1)-2 Tape dimensions

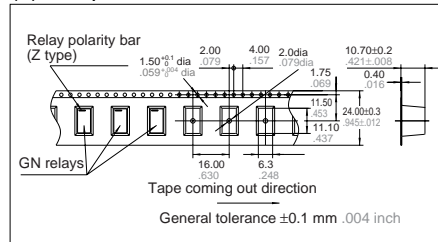

(2) Dimensions of plastic peel

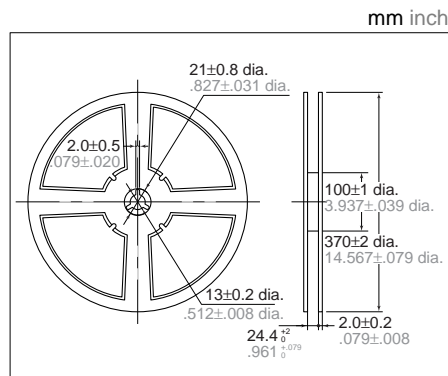

6. Automatic insertion

To maintain the internal function of the relay, the chucking pressure should not exceed the values below.

Chucking pressure in the direction A:

4.9 N {500gf} or less

Chucking pressure in the direction B:

9.8 N {1 kgf} or less

Chucking pressure in the direction C:

9.8 N {1 kgf} or less

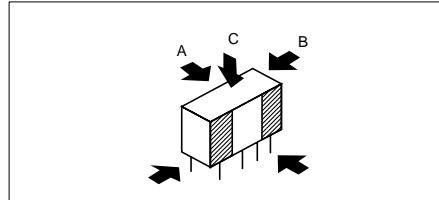

Please chuck the  portion.

Avoid chucking the center of the relay.

In addition, excessive chucking pressure to the pinpoint of the relay should be avoided.

For Cautions for Use, see Relay Technical Information (Page 48 to 76).