

# AKD4523

## Evaluation board Rev.A for AK4523

**General description**

AKD4523 is an evaluation board for audio codec, AK4523. A/D converter and D/A converter can be evaluated separately in addition to loopback mode(A/D → D/A). The A/D section can be evaluated by interfacing with AKM's DAC evaluation boards(AKD4319, AKD4320, AKD4321 and AKD4324) directly. The AKD4523 has the interface with AKM's wave generator using ROM data and AKM's ADC evaluation boards(AKD5391/2, AKD5330 and AKD5351/2). Therefore, it is easy to evaluate the D/A section. The AKD4523 also has the digital audio interface and can achieve the interface with digital audio systems via opt-connector

■ **Ordering guide**

AKD4523

--- Evaluation board of AK4523

**Function**

- On-Board analog input buffer circuit
- On-board clock generator
- Compatible with the following 2 types of interface
  - 1)Direct interface with AKM's A/D and D/A converter, direct interface with a signal generator(AKD43XX) by 10pin Header
  - 2)DIR/DIT with optical input/output
- A BNC connector for an external clock input

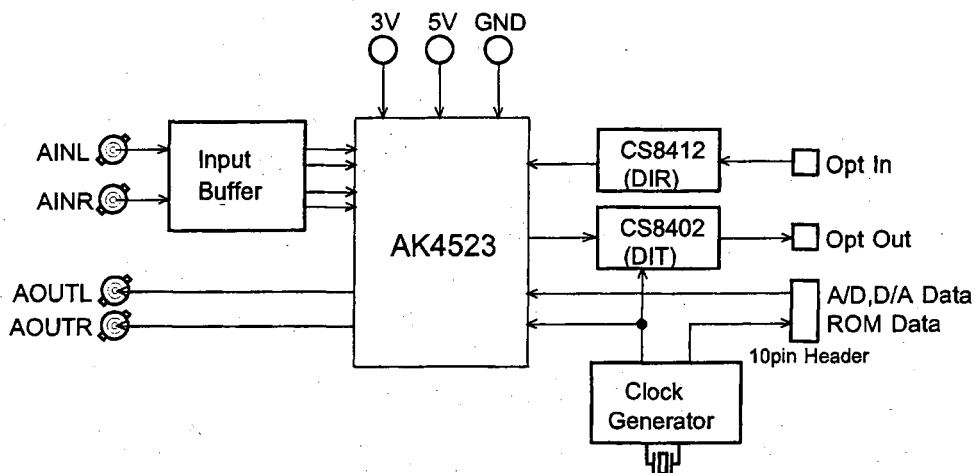
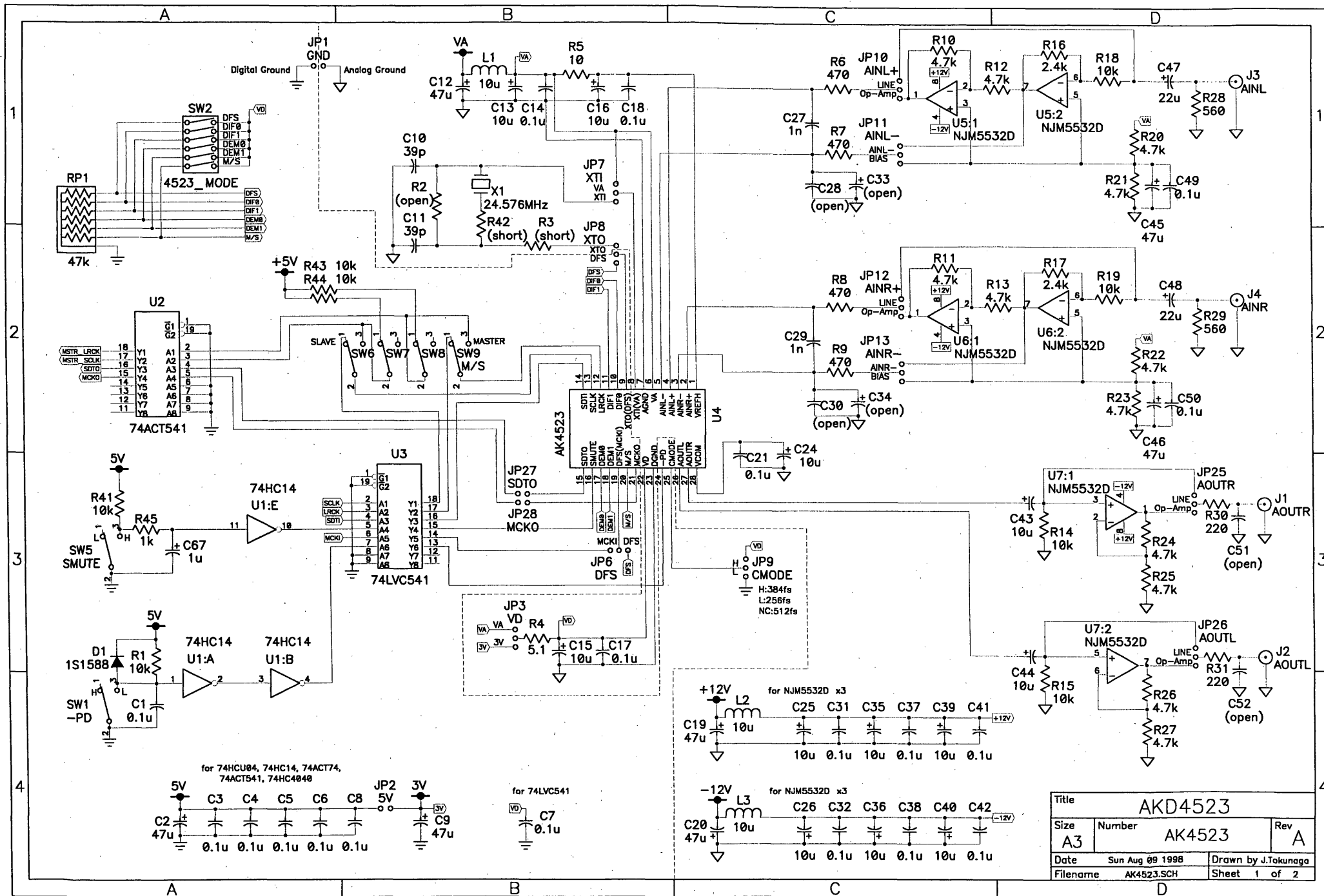
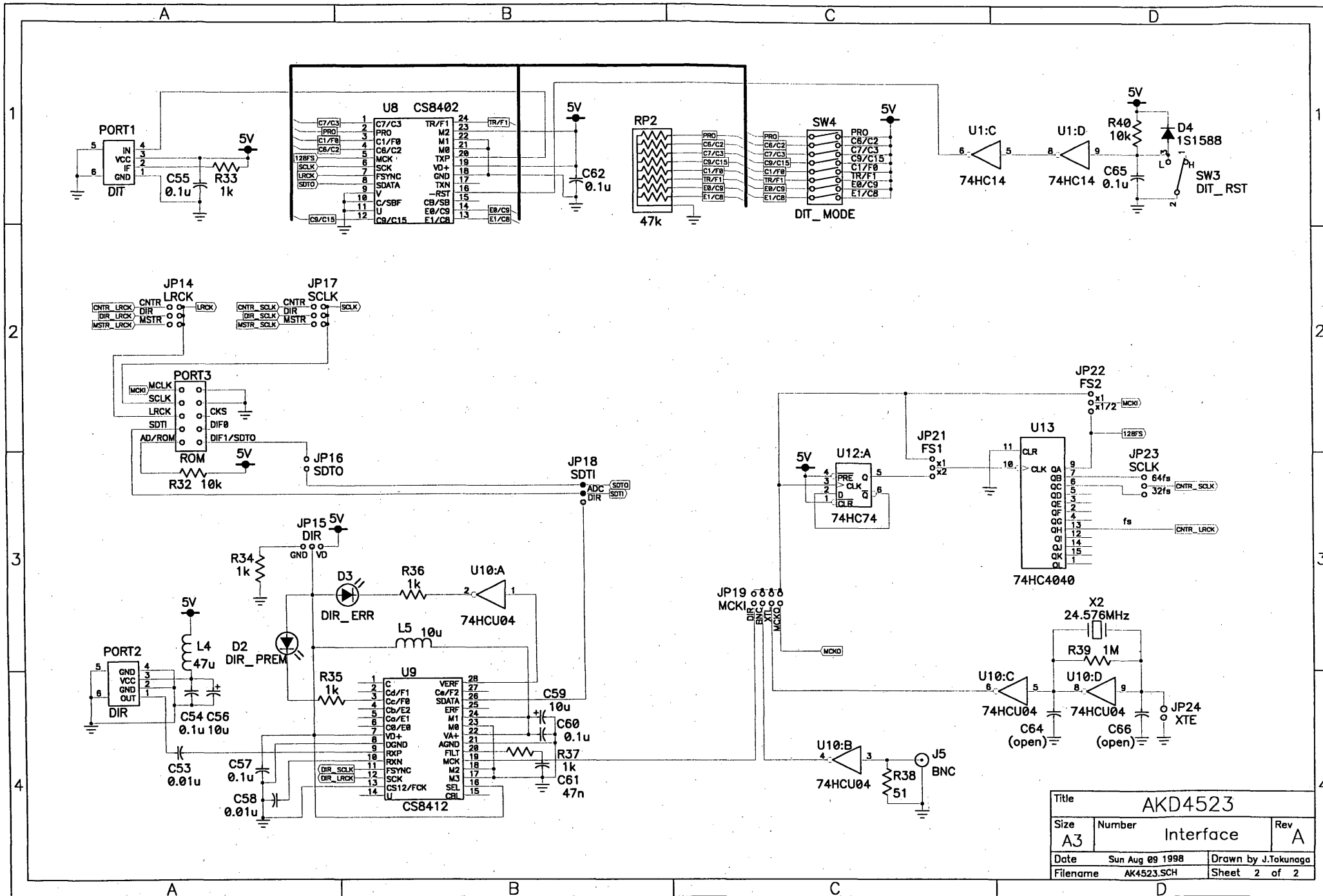

Figure 1. AKD4523 Block Diagram



Title			AKD4523		
Size	Number	AK4523		Rev	A
Date	Sun Aug 09 1998	Drawn by J.Takunaga			
Filename	AK4523.SCH	Sheet 1 of 2			



Title				AKD4523	
Size	Number	Interface	Rev		
A3			A		
Date	Sun Aug 09 1998	Drawn by J.Tokunaga			
Filename	AK4523.SCH	Sheet	2 of 2		

■ Analog Inputs

The ADC inputs are differential and internally biased to the common voltage( $V_A/2$ ) with  $30k\ \Omega$  (typ) resistance. The signal can be input from either positive or negative input, and the input signal range scales with the supply voltage and nominally  $0.6 \times V_{REFH}$  Vpp. In case of single ended input, the distortion around full scale degrades compared with differential input. The AK4523 can accept input voltages from AGND to  $V_A$ . The ADC output data format is 2's complement. The output code is 7FFFFH(@20bit) for input above a positive full scale and 80000H(@20bit) for input below a negative full scale. The ideal code is 00000H(@20bit) with no input signal. The DC offset is removed by the internal HPF.

1. In case of Full-Differential Inputs (default)

Non-inverted and inverted signal are input to AK4523 via inverted op-amp. Since gain of 1st op-amp is 0.24, maximum amplitude of the input signal can be about 4 times larger than spec of AK4523.

[JP10, JP12]	: Op-amp	C28, C30, C33, C34	: None
[JP11]	: AINL-	C27, C29	: 1nF
[JP13]	: AINR-		

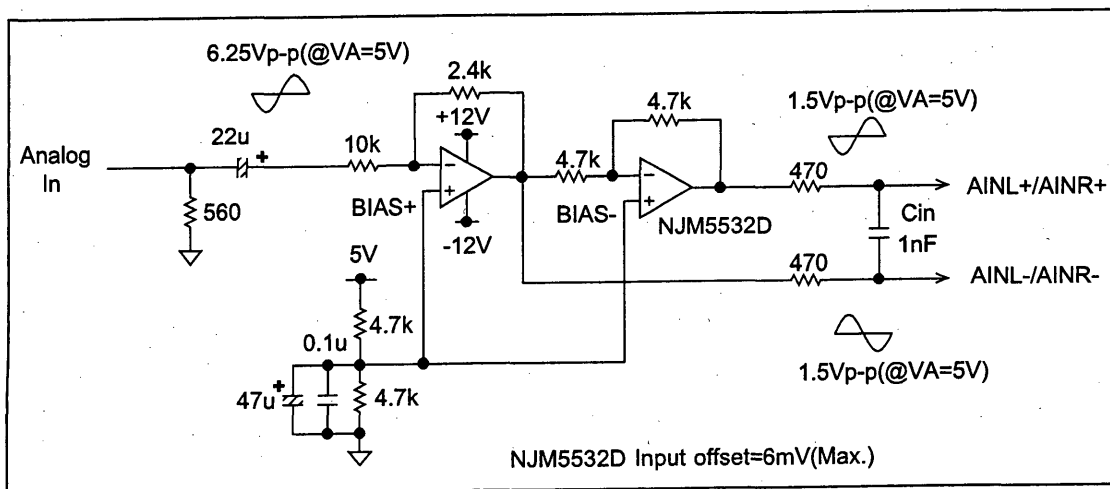

Figure 2. Full-differential Input Buffer Circuit Example

2. In case of Single-ended Input (bias voltage input)

In case of worrying Idle Tone Level, adds offset from external and moves it outside the audio band frequency. The difference between bias voltage of Op-amp and bias voltage( $V_A/2$ ) of internal device results in the offset. Two inverted op-amps are connected on the evaluation board, however, do not need 2nd op-amp. In this case, if inverted op-amp is input to AINL- or AINR- pin, can be corresponded with polarity. Since gain of 1st op-amp is 0.24, maximum amplitude of the input signal can be about 4 times larger than spec of AK4523.

[JP10, JP12]	: Op-amp	C28, C30, C33, C34	: None
[JP11]	: BIAS	C27, C29	: 1nF
[JP13]	: BIAS		



## ■ Grounding and Power Supply Decoupling of AK4523

The AK4523 requires careful attention to power supply and grounding arrangements. VA pin and VD pin are usually supplied from analog supply in system. Alternatively if VA pin and VD pin are supplied separately, the power up sequence is not critical. AGND pin and DGND pin of the AK4523 should be connected to analog ground plane. System analog ground and digital ground should be connected together near to where the supplies are brought onto the printed circuit board. Decoupling capacitors should be as near to the AK4523 as possible, with the small value ceramic capacitor being the nearest.

## ■ Voltage Reference Inputs of AK4523

The differential Voltage between VREFH pin and AGND pin sets the analog input/output range. VREFH pin is normally connected to VA pin with a 0.1uF ceramic capacitor. VCOM pin is a signal ground of this chip. An electrolytic capacitor 10uF parallel with a 0.1uF ceramic capacitor attached to VCOM pin eliminates the effects of high frequency noise. No load current may be drawn from VCOM pin. All signals, especially clocks, should be kept away from the VREFH and VCOM pins in order to avoid unwanted coupling into the AK4523.

## ■ Operation sequence

### ① Set up the power supply lines.

[VA]	(red)	= 4.5 ~ 5.5V	( VA of AK4523 )
[3V]	(orange)	= 2.7 ~ 5.5V	( VD of AK4523 )
[5V]	(red)	= 3.5 ~ 5.5V	( Power supply to digital interface )
[+12V]	(orange)	= 12 ~ 15V	( Op-amp )
[-12V]	(blue)	= -12 ~ -15V	( Op-amp )
[AGND]	(black)	= 0V	( AGND,DGND of AK4523 and Ground of analog interface )
[DGND]	(black)	= 0V	( Ground of digital interface )

Each supply line should be distributed from the power supply unit.

#### 1. VD of AK4523 and Power supply to digital interface

In case of separated	[JP2] : open
In case of common	[JP2] : short

#### 2. VA and VD of AK4523

In case of separated	[JP3] : 3V
In case of common	[JP3] : VA

#### 3. Analog ground (includes AGND and DGND of AK4523) and digital ground

In case of separated	[JP1] : open
In case of common	[JP1] : short

### ② Set up the evaluation modes and jumper pins. (See p.7 ~)

There are many jumper pins to cover many evaluation mode. Please take care of setting.

### ③ Set up the DIP-SW.

- SW2 : Set up AK4523 (See p.10)
- SW4 : Set up CS8402 (See p.11)
- (Upper side is "ON" and lower side is "OFF".)

### ④ Power on.

The AK4523 should be reset once bringing  $\overline{\text{PD}}$  (SW1)"L" upon power-up.

■ Evaluation modes and jumper pins

Applicable Evaluation Mode

- ① Loopback mode (Default)
- ② Evaluation of D/A using ideal sine wave generated by ROM data.
- ③ Evaluation of D/A using A/D converted data
- ④ Evaluation of D/A using DIR(Optical Link)
- ⑤ Evaluation of A/D using D/A converted data
- ⑥ Evaluation of A/D DIT(Optical Link)
- ⑦ All interface signals including master clock are fed externally.

※① and ⑥ can be evaluated at the same time by the same set up.

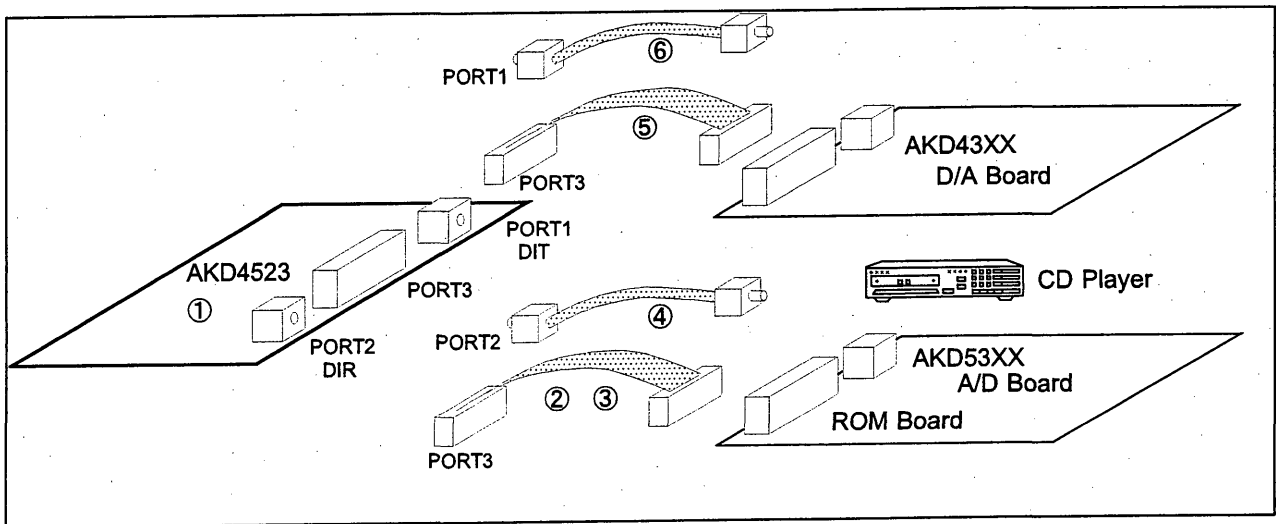

Figure 4. Wiring cables corresponded some evaluation modes

① Loopback mode (Default)

Nothing should be connected to PORT2, PORT3. If master clock is supplied from X2 in slave mode, set-up of each jumper switches is as follows. If supplied from except for X2, see Table 2.(p.9). In master mode, see Table 1.(p.8).

[JP15] (DIR)	: GND	[JP14] (LRCK)	: ADC
[JP19] (MCKI)	: XTL	[JP17] (SCLK)	: ADC
[JP24] (XTE)	: open	[JP18] (SDTI)	: ADC

② Evaluation of D/A using A/D converted data from ideal sine wave generated by ROM data

Digital signals generated by AKD43XX are used. PORT3 is used for the interface with AKD43XX. Master clock is sent from AKD4523 to AKD43XX and SCLK, LRCK, SDATA are sent from AKD43XX to AKD4523. Nothing should be connected to PORT2. If master clock is supplied from X2, set-up of each jumper switches is as follows. If supplied from except for X2, see Table 2.(p.9). Set slave mode (see p.8 Table 1.).

[JP15] (DIR)	: GND	[JP14] (LRCK)	: open
[JP19] (MCKI)	: XTL	[JP17] (SCLK)	: open
[JP24] (XTE)	: open	[JP18] (SDTI)	: open

## ③ Evaluation of D/A using A/D converted data

It is possible to make evaluation in the form of analog inputs and analog outputs by interfacing with various AKM's A/D evaluation boards (AKD5391/2, AKD5330 and AKD5352/1) with PORT3. Master clock, SCLK, LRCK and SDATA are sent from A/D board to AKD4523. Nothing should be connected to PORT2. Set slave mode (see p.8 Table 1.).

[JP15] (DIR)	: GND	[JP14] (LRCK)	: open
[JP19] (MCKI)	: open	[JP17] (SCLK)	: open
[JP24] (XTE)	: short	[JP18] (SDTI)	: open

## ④ Evaluation of D/A using DIR (Optical Link)

PORT2 is used. DIR generates MCLK, SCLK LRCK and SDATA from the received data through optical connector(TORX174). Used for the evaluation using CD test disk. Nothing should be connected to PORT3. CS8412(DIR) needs the operating voltage of  $VD+ \geq 3.2V$ . Set slave mode (see p.8 Table 1.).

[JP15] (DIR)	: VD	[JP14] (LRCK)	: DIR
[JP19] (MCKI)	: DIR	[JP17] (SCLK)	: DIR
[JP24] (XTE)	: short	[JP18] (SDTI)	: DIR

## ⑤ Evaluation of A/D using D/A converted data

It is possible to make evaluation in the form of analog inputs and analog outputs by interfacing with various AKM's D/A evaluation boards (AKD4319, AKD4320 AKD4321 and AKD4324) with PORT3. Nothing should be connected to PORT2. If master clock is supplied from X2 in slave mode, set-up of each jumper switches is as follows. If supplied from except for X2, see Table 2.(p.9). In master mode, see Table 1.(p.8).

[JP15] (DIR)	: GND	[JP14] (LRCK)	: ADC
[JP19] (MCKI)	: XTL	[JP17] (SCLK)	: ADC
[JP24] (XTE)	: open	[JP18] (SDTI)	: ADC

## ⑥ Evaluation of A/D using DIT (Optical Link)

PORT1 is used. DIT generates SDATA from received data and which is output through optical connector (TOTX174). It is possible to connect AKM's evaluation boards (AKD4319, AKD4320, AKD4321 and AKD4324), digital-amplifier and etc. Nothing should be connected to PORT2, PORT3. This set-up is same as that of ①. CS8402(DIT) needs the operating voltage of  $VD+ \geq 3.2V$ . SW5 should be kept "H" during normal operation. If master clock is supplied from X2 in slave mode, set-up of each jumper switches is as follows. If supplied from except for X2, see Table 2.(p.9). In master mode, see Table 1.(p.8).

[JP15] (DIR)	: GND	[JP14] (LRCK)	: ADC
[JP19] (MCKI)	: XTL	[JP17] (SCLK)	: ADC
[JP24] (XTE)	: open	[JP18] (SDTI)	: ADC

## ⑦ All interfacing signals including master clock are fed externally.

Under the following set-up, all external signals needed for the AK4523 to operate could be fed through PORT3. Set slave mode (see p.8 Table 1.).

[JP15] (DIR)	: GND	[JP14] (LRCK)	: open
[JP19] (MCKI)	: open	[JP17] (SCLK)	: open
[JP24] (XTE)	: short	[JP18] (SDTI)	: open

## ■ Master / Slave mode set-up

	Master mode	Slave mode (default)
SW2-6(M/S)	ON	OFF
SW6,7,8,9	Master	Slave
JP14, JP17	MSTR	See above

Table 1. Master / Slave mode set-up



### ■ Selection of master clock

	Internal clock (X1)	External clock (X2,J5,PORT2)
JP7	XTI	VA
JP8	XTO	DFS
JP6	DFS	MCKI

Table 2. Selection of master clock

Master clock is X2 at default.

### ■ Master clock set-up

		SW2 DFS	JP9 CMODE	JP21 FS1	JP22 FS2	
Normal Speed	256fs	OFF	L	x1	x1	(default)
	512fs	OFF	open	x2	x1	
Double Speed	128fs	ON	L	x1	x1/2	
	256fs	ON	open	x1	x1	

Table 3. Master clock set-up

In master mode, 128fs set-up cannot be used.

### ■ SCLK set-up

SCLK can be selected 64fs or 32fs by JP23(SCLK). In master mode, set 64fs. SCLK is 64fs at default.

### ■ Other jumpers set-up

[JP27, JP27] : short (always)  
[JP16] : open (always)

### ■ The function of the toggle SW.

[SW1] : Resets the AK4523. Keep "H" during normal operation.  
[SW5] : Initiates soft mute cycle of AK4523. If this switch goes "H", soft mute cycle is initiated.  
Keep "L" during normal operation.  
[SW3] : Resets the CS8402. "L" resets the internal counter of CS8402, then Bi-phase signal is not output.  
Keep "H" during normal operation.  
(Upper-side is "H" and lower-side is "L".)

### ■ The indication content for LED.

[D3] : Monitors VERF pin of the CS8412. LED turns on when some error has occurred to CS8412.  
[D2] : Indicates whether the input data of CS8412 is pre-emphasized or not.  
LED turns on when the data is pre-emphasized.

■ DIP switch set-up

[SW3] : This switch sets up the operation mode of the AK4523.  
 Confirm the set-up of the DIP-SW before evaluation starts.  
 Refer to AK4523 data-sheet about detail information. ON means "H" and OFF, "L".  
 Since formats of CS8402, CS8412 are fixed IIS(I2S), set DIF1,0 ON if use them.

No.	PIN	ON	OFF	default
1	DFS	Double Speed	Normal Speed	OFF
2	DIF0	Serial Data Interface Format Mode (See Table 5.)		ON
3	DIF1			ON
4	DEM0	De-emphasis filter control (See Table 6.)		ON
5	DEM1			OFF
6	M/S	Master mode	Slave mode	OFF

Table 4. Set-up of SW2(4523\_MODE)

Mode	DIF1	DIF0	SDTO(ADC)	SDTI(DAC)	L/R	SCLK
0	OFF	OFF	20bit, MSB justified	16bit, LSB justified	H/L	64fs, 32fs
1	OFF	ON	20bit, MSB justified	20bit, LSB justified	H/L	64fs
2	ON	OFF	20bit, MSB justified	20bit, MSB justified	H/L	64fs
3	ON	ON	IIS(I2S)	IIS(I2S)	L/H	64fs, 32fs

(default)

Table 5. Serial Data Interface Format Mode

DFS	DEM1	DEM0	Mode
OFF	OFF	OFF	44.1kHz
OFF	OFF	ON	OFF
OFF	ON	OFF	48kHz
OFF	ON	ON	32kHz
ON	OFF	OFF	OFF
ON	OFF	ON	OFF
ON	ON	OFF	OFF
ON	ON	ON	OFF

(default)

Table 6. De-emphasis filter control

[SW4] : This switch sets the C-bit of CS8402. (Default is the consumer mode)

This set-up does not affect the evaluation of the AK4523. In case of using DIT, need to set it up correctly. For more detailed configurations, please refer to the CS8402 data-sheet.

Switch	OFF=0,ON=1	Contents
1	$\overline{\text{PRO}}=0$	Professional mode, C0=1
2,3	$\overline{\text{C6,C7}}$	C6,C7 - Sampling frequency
	1 1	00 - Not indicated. Receiver default to 48kHz.
	1 0	01 - 48kHz
	0 1	10 - 44.1kHz
	0 0	11 - 32kHz
4	$\overline{\text{C9}}$	C8,C9,C10,C11 - 1bit of channel mode
	1	0000 - Mode not indicated. Receiver default to
	0	2-channel mode.
		0100 - Stereophonic.
5	$\overline{\text{C1}}$	C1 - Audio mode
	1	0 - Normal audio
	0	1 - Non-audio
6	TRNPT	Transparent mode * CS8402 is CRE
	0	Normal mode
	1	Transparent mode
8,7	EM1,EM0	C2,C3,C4 - Encoded audio signal emphasis
	1 1	000 - Emphasis not indicated. Receiver defaults to no
	1 0	emphasis with manual override enabled.
	0 1	100 - None
	0 0	110 - 50/15usec
		111 - CCITT J.17

Table 7. DIP switch set-up of CS8402 (Professional mode)

Switch	OFF=0,ON=1	Contents
1	$\overline{\text{PRO}}=1$	Consumer mode, C0=0 (Default)
2	$\overline{\text{C2}}$	C2 - Copy
	1	0 - Copy inhibited
Default	0	1 - Copy permitted
3	$\overline{\text{C3}}$	C3,C4,C5 - Pre-emphasis
	1	000 - None
Default	0	100 - 50/15usec
4	$\overline{\text{C15}}$	C15 - Generation Status
	1	0 - See the standard
Default	0	1 - See the standard
6,5	FC1,FC0	C24,C25,C26,C27- Sampling frequency
	0 0	0000 - 44.1kHz
	0 1	0100 - 48kHz
	1 0	1100 - 32kHz
Default	1 1	0000 - 44.1kHz, CD mode
8,7	$\overline{\text{C8,C9}}$	C8-C14 - Category code
	1 1	0000000 - General
	1 0	0100000 - PCM encoder/decoder
Default	0 1	1000000 - CD
	0 0	1100000 - DAT

Table 8. DIP switch set-up of CS8402 (Consumer mode)

**AK4523 Measurement Results**

**[Measurement Condition]**

- Measurement unit : ROHDE & SCHWARZ, UPD04
- MCLK : 256fs
- BCLK : 64fs
- Bit : 20bit
- fs : 44.1kHz
- Power Supply : VA=5V, VD=5V/3V
- Interface : DIT/DIR
- Temperature : Room

**1. A/D Output (Full-differential inputs, refer to Figure 2.)**

Parameter	Input signal	Measurement Filter	VD = 5V	VD = 3V
S/(N+D)	1kHz, -0.5dB	20kLPF	92.2 dB	92.5 dB
Dynamic Range	1kHz, -20dB	20kLPF	96.7 dB	96.9 dB
		20kLPF, A-weight	100.5 dB	100.7 dB
	1kHz, -60dB	20kLPF	96.7 dB	96.9 dB
		20kLPF, A-weight	100.0 dB	100.2 dB
S/N	1kHz, 0dB/GND IN	20kLPF	97.0 dB	97.3 dB
		20kLPF, A-weight	101.0 dB	101.1 dB

**4. D/A Output**

Parameter	Input signal	Measurement Filter	VD = 5V	VD = 3V
S/(N+D)	1kHz, 0dB	20kLPF	90.6 dB	90.7 dB
Dynamic Range	1kHz, -20dB	20kLPF	97.0 dB	97.1 dB
		20kLPF, A-weight	100.4 dB	100.5 dB
	1kHz, -60dB	20kLPF	97.1 dB	97.2 dB
		20kLPF, A-weight	100.6 dB	100.5 dB
S/N	1kHz, 0dB / "0" data IN	20kLPF	97.2 dB	97.3 dB
		20kLPF, A-weight	100.6 dB	100.6 dB

[Measurement Condition]

- Measurement unit : Audio Precision System two
- MCLK : 256fs
- BCLK : 64fs
- Bit : 20bit
- fs : 44.1kHz
- Power Supply : VA=5V, VD=5V/3V
- Interface : DIT/DIR
- Temperature : Room

1. A/D Output (Full-differential inputs, refer to Figure 2.)

Parameter	Input signal	Measurement Filter	VD = 5V	VD = 3V
S/(N+D)	1kHz, -0.5dB	20kLPF	94.7 dB	94.9 dB
Dynamic Range	1kHz, -20dB	20kLPF	97.0 dB	97.1 dB
		20kLPF, A-weight	99.8 dB	100.0 dB
	1kHz, -60dB	20kLPF	97.0 dB	97.2 dB
		20kLPF, A-weight	99.7 dB	100.0 dB
S/N	1kHz, 0dB/GND IN	20kLPF	97.1 dB	97.2 dB
		20kLPF, A-weight	100.1 dB	100.1 dB

2. A/D Output (Single-ended inputs with external bias, refer to Figure 3.)

Parameter	Input signal	Measurement Filter	VD = 5V	VD = 3V
S/(N+D)	1kHz, -0.5dB	20kLPF	80.8 dB	82.2 dB
Dynamic Range	1kHz, -20dB	20kLPF	97.0 dB	97.2 dB
		20kLPF, A-weight	99.8 dB	100.0 dB
	1kHz, -60dB	20kLPF	97.1 dB	97.4 dB
		20kLPF, A-weight	99.7 dB	100.0 dB
S/N	1kHz, 0dB/GND IN	20kLPF	97.3 dB	97.5 dB
		20kLPF, A-weight	100.1 dB	100.5 dB

3. A/D Output (Single-ended inputs without external bias, refer to Figure 4.)

Parameter	Input signal	Measurement Filter	VD = 5V	VD = 3V
S/(N+D)	1kHz, -0.5dB	20kLPF	79.7 dB	81.2 dB
Dynamic Range	1kHz, -20dB	20kLPF	97.1 dB	97.3 dB
		20kLPF, A-weight	99.9 dB	100.2 dB
	1kHz, -60dB	20kLPF	97.2 dB	97.5 dB
		20kLPF, A-weight	100.2 dB	100.4 dB
S/N	1kHz, 0dB/GND IN	20kLPF	97.2 dB	97.6 dB
		20kLPF, A-weight	100.3 dB	100.6 dB

Parameter	Input signal	Measurement Filter	VD = 5V	VD = 3V
S/(N+D)	1kHz, 0dB	20kLPF	91.4 dB	91.5 dB
Dynamic Range	1kHz, -20dB	20kLPF	97.0 dB	97.0 dB
		A-weight	99.6 dB	99.6 dB
	1kHz, -60dB	20kLPF	97.0 dB	97.0 dB
		A-weight	99.5 dB	99.6 dB
S/N	1kHz, 0dB / "0" data IN	20kLPF	97.0 dB	97.1 dB
		A-weight	99.6 dB	99.7 dB

## 5. A/D→D/A Loopback Output (Full-differential inputs, refer to Figure 2.)

Parameter	Input signal	Measurement Filter	VD = 5V	VD = 3V
S/(N+D)	1kHz, 0dB	20kLPF	89.3 dB	89.5 dB
Dynamic Range	1kHz, -20dB	20kLPF	93.9 dB	94.0 dB
		A-weight	96.6 dB	96.8 dB
	1kHz, -60dB	20kLPF	93.9 dB	94.0 dB
		A-weight	96.5 dB	96.7 dB
S/N	1kHz, 0dB/GND IN	20kLPF	93.9 dB	93.9 dB
		A-weight	96.7 dB	96.7 dB

## 6. A/D→D/A Loopback Output (Single-ended inputs with external bias, refer to Figure 3.)

Parameter	Input signal	Measurement Filter	VD = 5V	VD = 3V
S/(N+D)	1kHz, 0dB	20kLPF	79.1 dB	80.3 dB
Dynamic Range	1kHz, -20dB	20kLPF	94.0 dB	94.0 dB
		A-weight	96.6 dB	96.8 dB
	1kHz, -60dB	20kLPF	93.9 dB	94.0 dB
		A-weight	96.4 dB	96.7 dB
S/N	1kHz, 0dB/GND IN	20kLPF	94.0 dB	94.1 dB
		A-weight	96.8 dB	96.9 dB

## 7. A/D→D/A Loopback Output (Single-ended inputs without external bias, refer to Figure 4.)

Parameter	Input signal	Measurement Filter	VD = 5V	VD = 3V
S/(N+D)	1kHz, 0dB	20kLPF	78.2 dB	79.4 dB
Dynamic Range	1kHz, -20dB	20kLPF	94.0 dB	94.1 dB
		A-weight	96.6 dB	96.8 dB
	1kHz, -60dB	20kLPF	94.0 dB	94.1 dB
		A-weight	96.9 dB	97.0 dB
S/N	1kHz, 0dB/GND IN	20kLPF	93.9 dB	94.0 dB
		A-weight	96.8 dB	97.0 dB

**AK4523 ADC part****Conditions :**

AVDD = DVDD = 5.0V

fs = 44.1kHz, MCLK = 256fs, BICK = 64fs,

Measurement unit = ROHDE &amp; SCHWARZ UPD04

Interface = DIT

**Contents :**

Figure 34 : THD+N vs. Input level	..... p.16
Figure 35 : THD+N vs. Input frequency	
Figure 36 : Linearity	..... p.17
Figure 37 : Frequency response	
Figure 38 : Cross talk	..... p.18
Figure 39 : FFT (Full-differential input : 1kHz,-0.5dBFS)	
Figure 40 : FFT (Single-ended input (bias input) : 1kHz,-0.5dBFS)	..... p.19
Figure 41 : FFT (Single-ended input (no bias) : 1kHz,-0.5dBFS)	
Figure 42 : FFT (Full-differential input : 1kHz,-60dBFS)	..... p.20
Figure 43 : FFT (noise floor)	

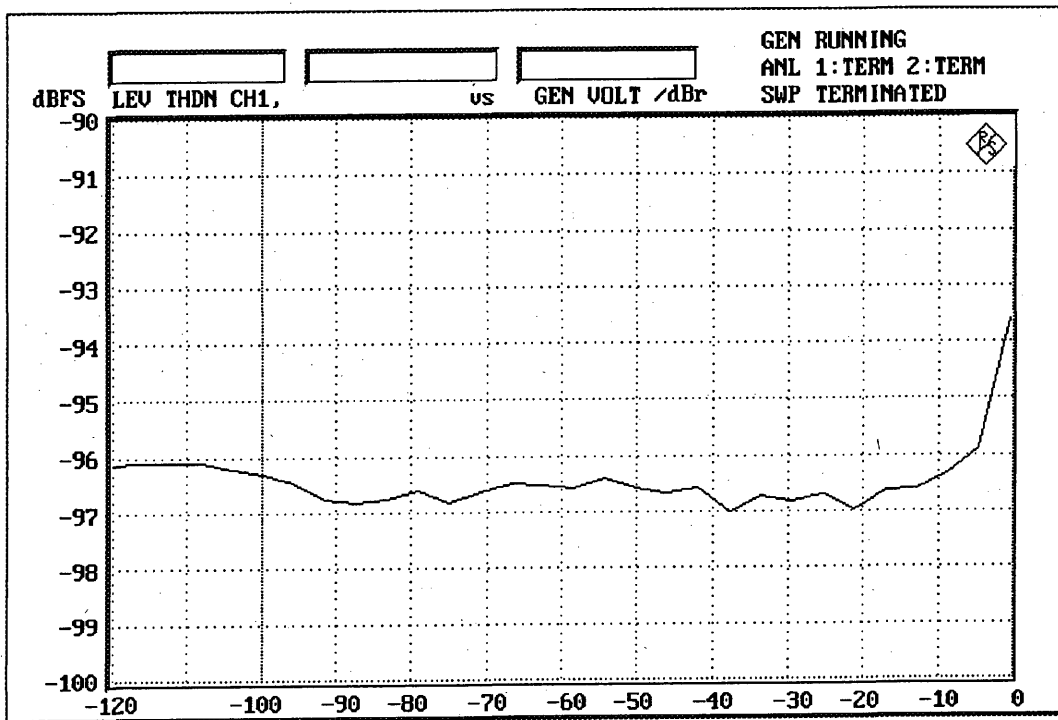

Figure 34 : THD+N vs. Input level (fin : 1kHz (Full-differential input))

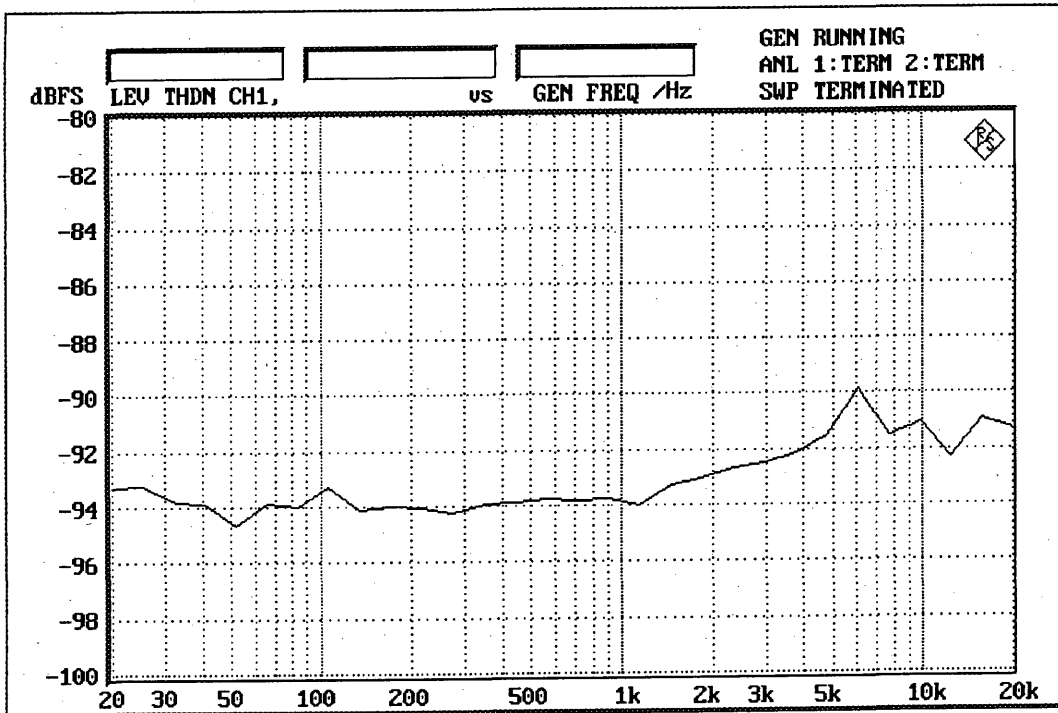

Figure 35 : THD+N vs. Input frequency (input level : -0.5dBFS (Full-differential input))



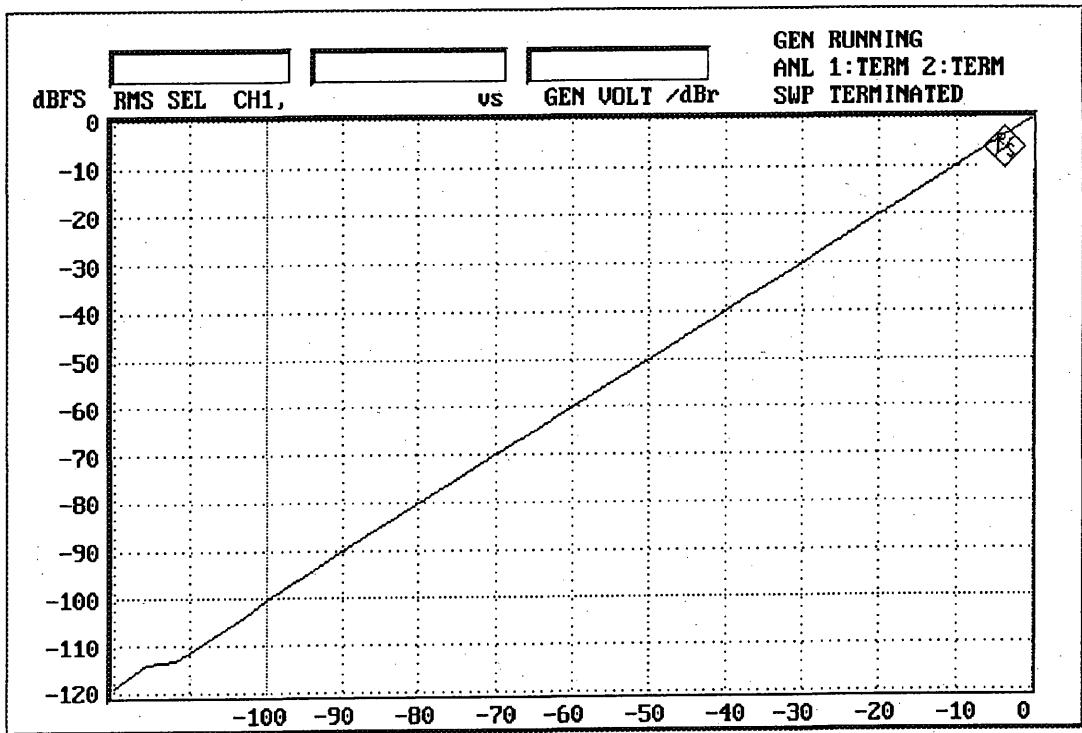

Figure 36 : Linearity (fin : 1kHz)

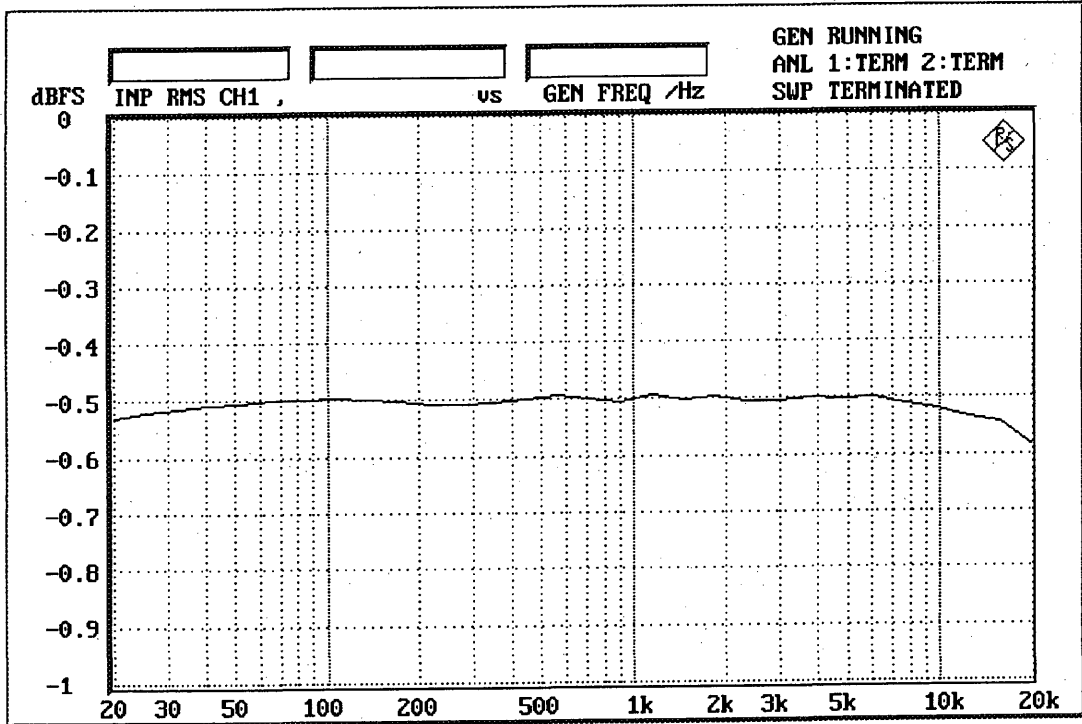

Figure 37 : Frequency response (input level : -0.5dBFS)

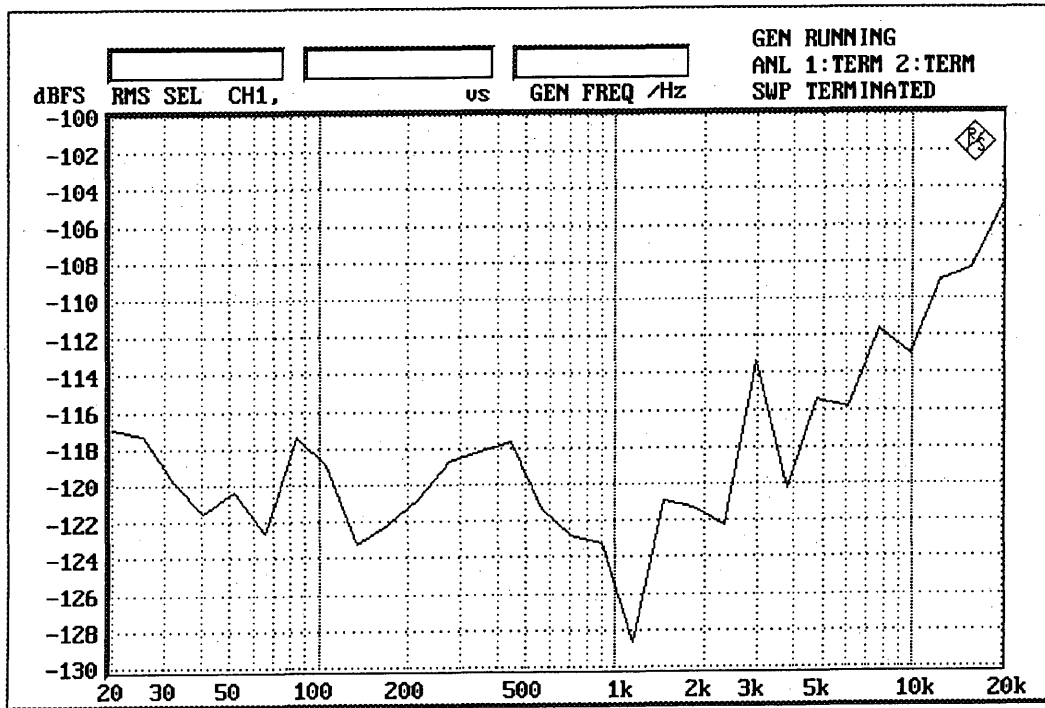

Figure 38 : Cross talk

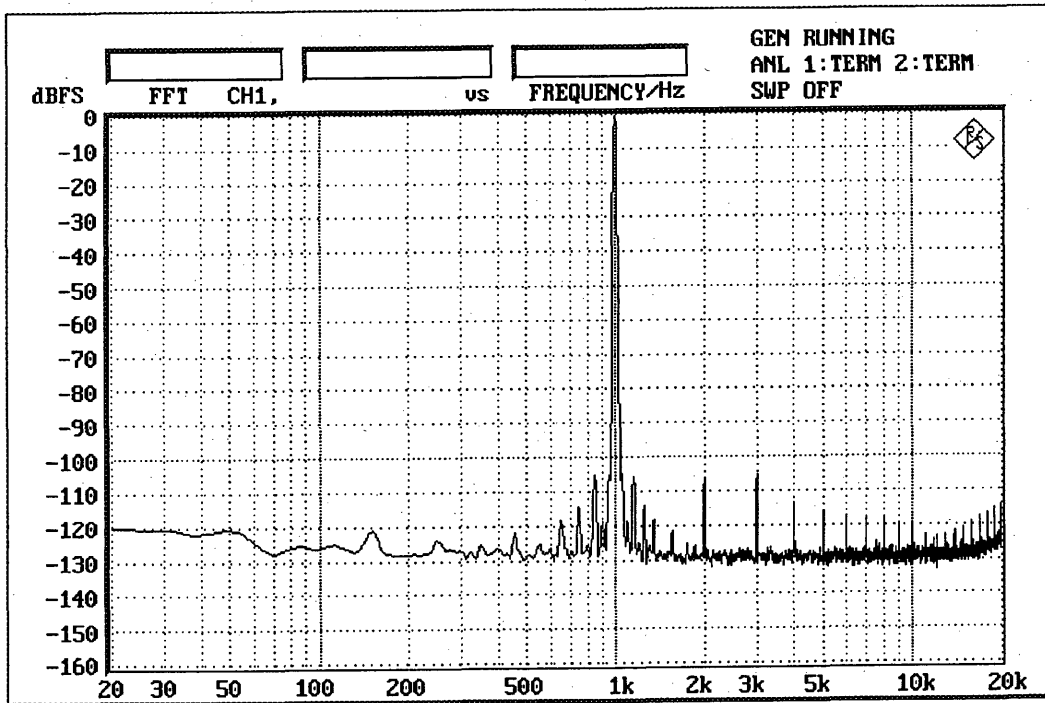

Figure 39 : FFT (Full-differential input : 1kHz, -0.5dBFS ;

FFT points : 8192, averaging : 10)

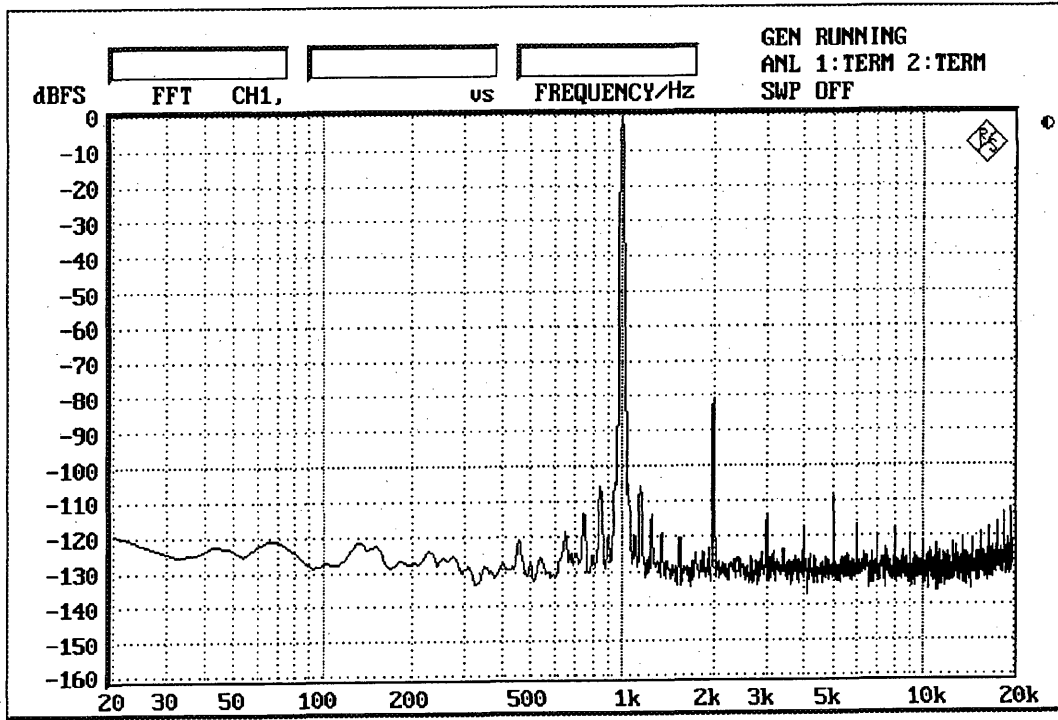

Figure 40 : FFT (Single-ended input(bias input) : 1kHz, -0.5dBFS ;

FFT points : 8192, averaging : 10)

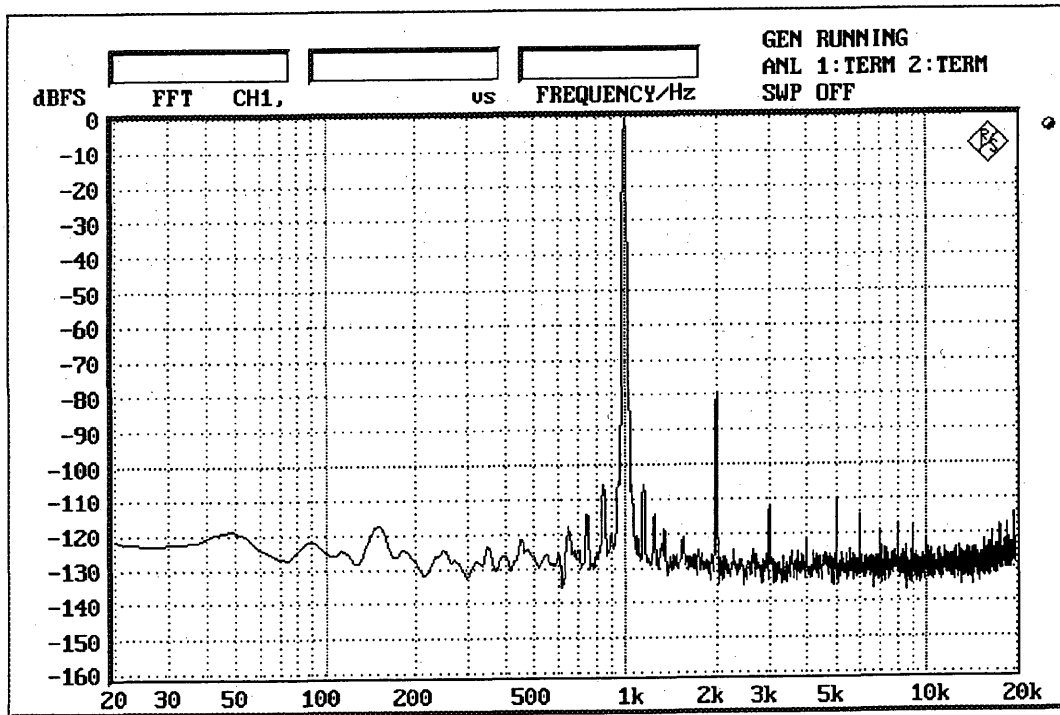

Figure 41 : FFT (Single-ended input (no bias) : 1kHz, -0.5dBFS ;

FFT points : 8192, averaging : 10)

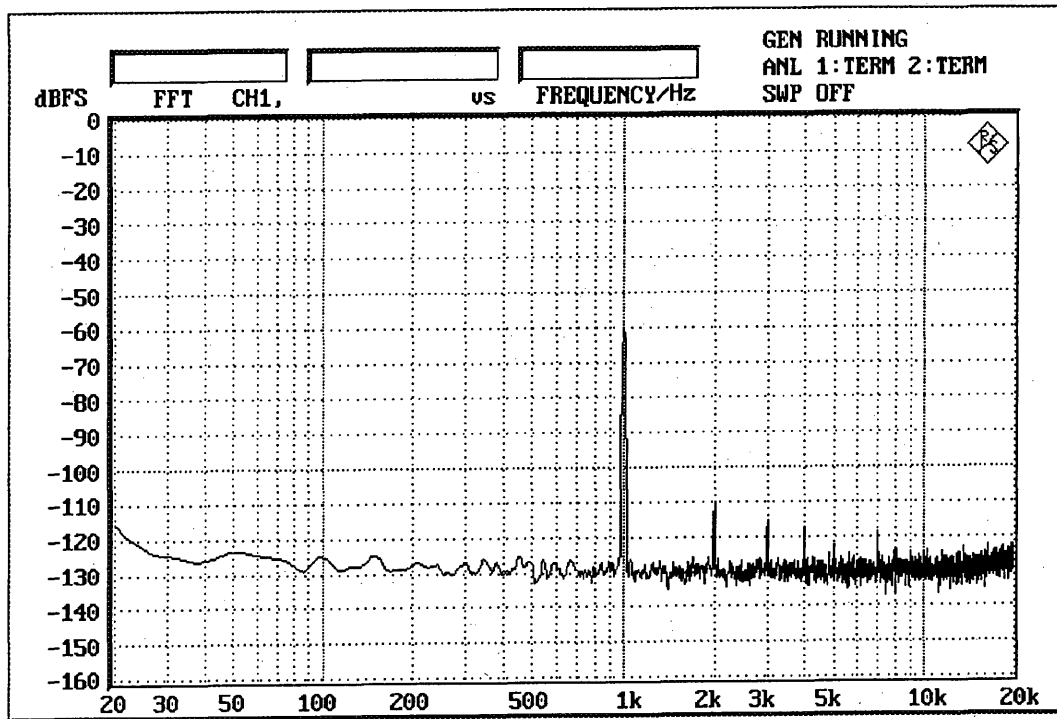

Figure 42 : FFT (Full-differential input : 1kHz, -60dBFS ;

FFT points : 8192, averaging : 10)

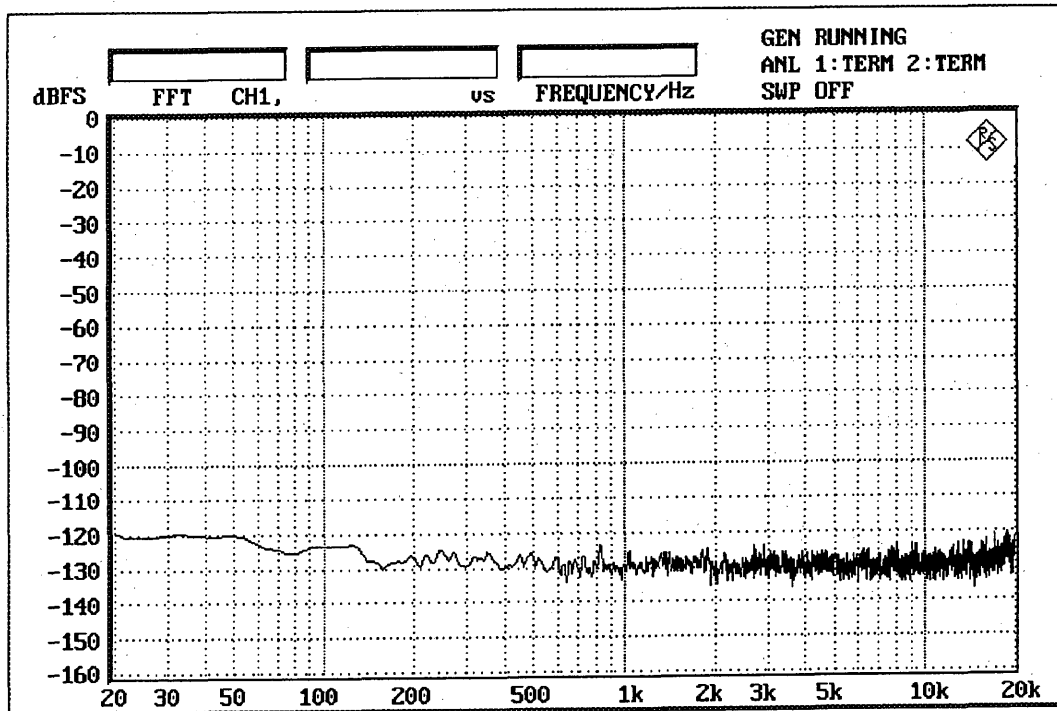

Figure 43 : FFT (noise floor ;

FFT points : 8192, averaging : 10)

AK4523 DAC part

## Conditions :

AVDD = DVDD = 5.0V

fs = 44.1kHz, MCLK = 256fs, BICK = 64fs,

Measurement unit = ROHDE &amp; SCHWARZ UPD04

Interface = DIR

## Contents :

Figure 44 : THD+N vs. Input level	.....	p.22
Figure 45 : THD+N vs. Input frequency		
Figure 46 : Linearity	.....	p.23
Figure 47 : Frequency response		
Figure 48 : Cross talk	.....	p.24
Figure 49 : FFT (input signal : 1kHz,0dBFS)		
Figure 50 : FFT (input signal : 1kHz,-60dBFS)	.....	p.25
Figure 51 : FFT (noise floor)		
Figure 52 : FFT (out-of-band noise ~300kHz)	.....	p.26

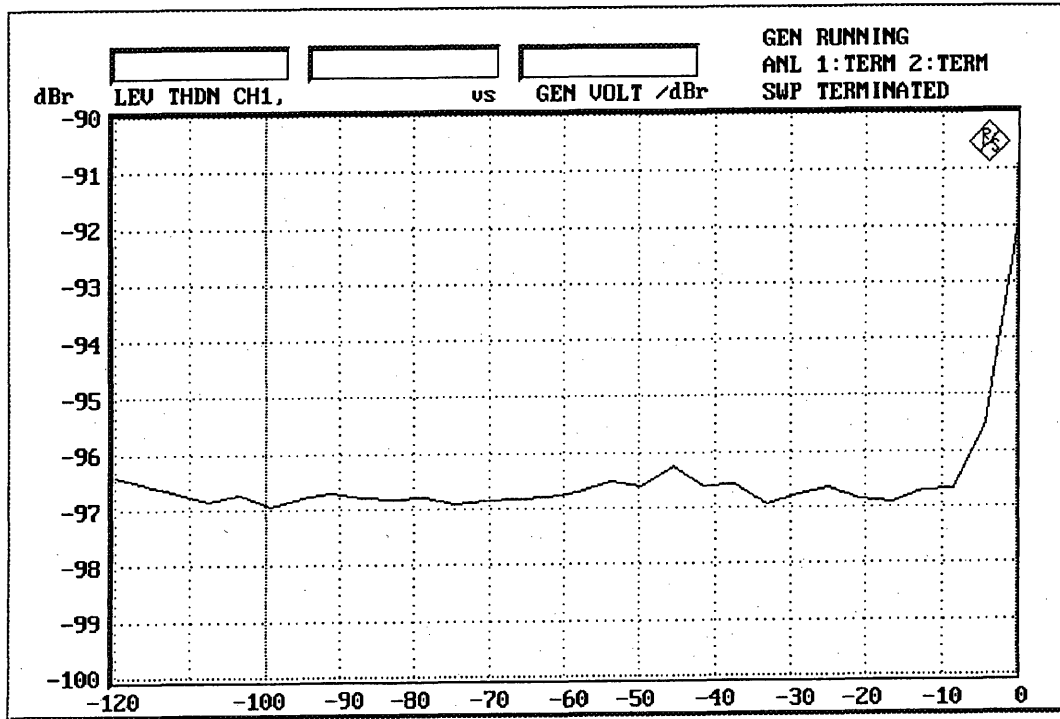

Figure 44 : THD+N vs. Input level (fin : 1kHz)

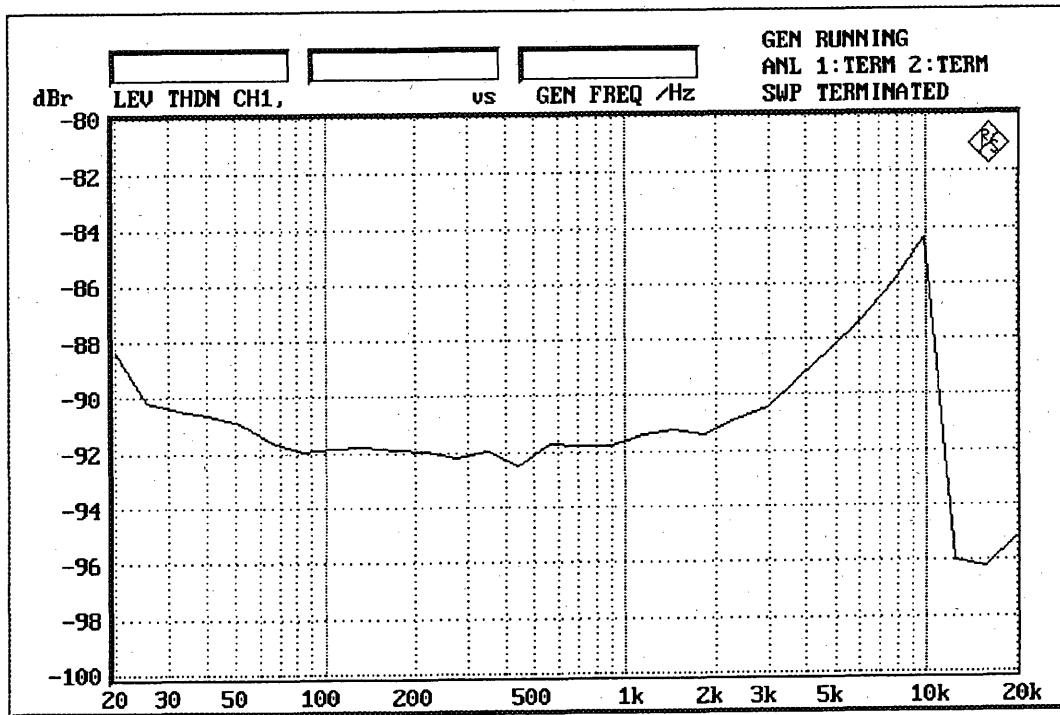

Figure 45 : THD+N vs. Input frequency (input level : 0dBFS)

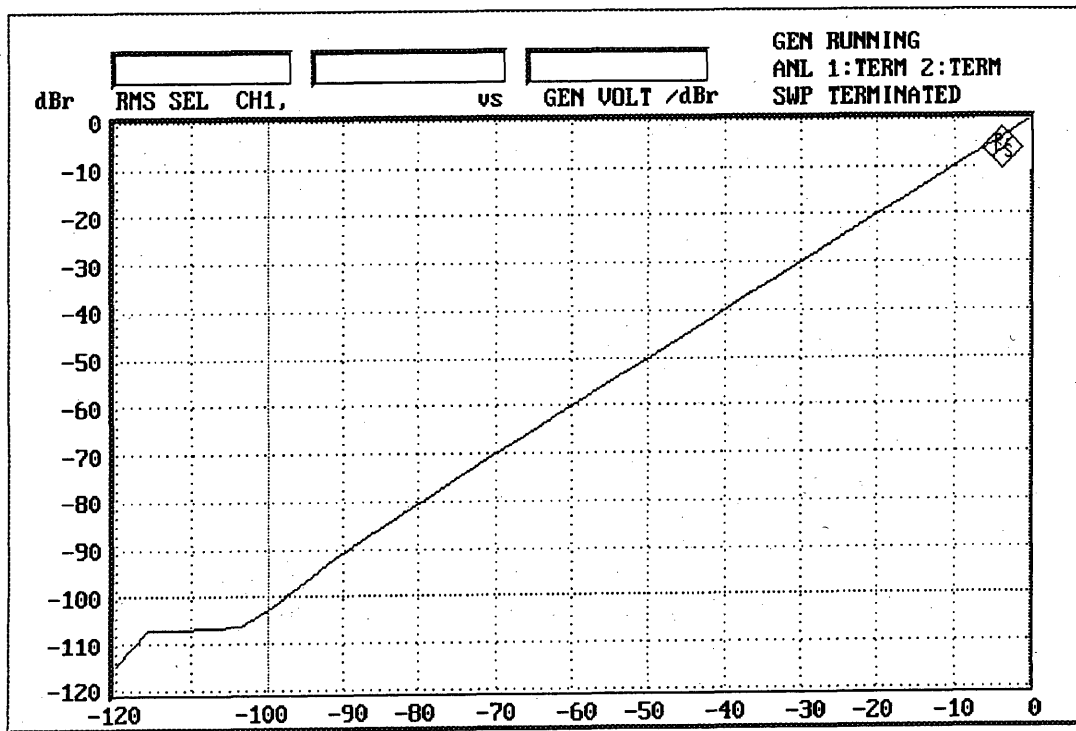

Figure 46 : Linearity (fin : 1kHz)

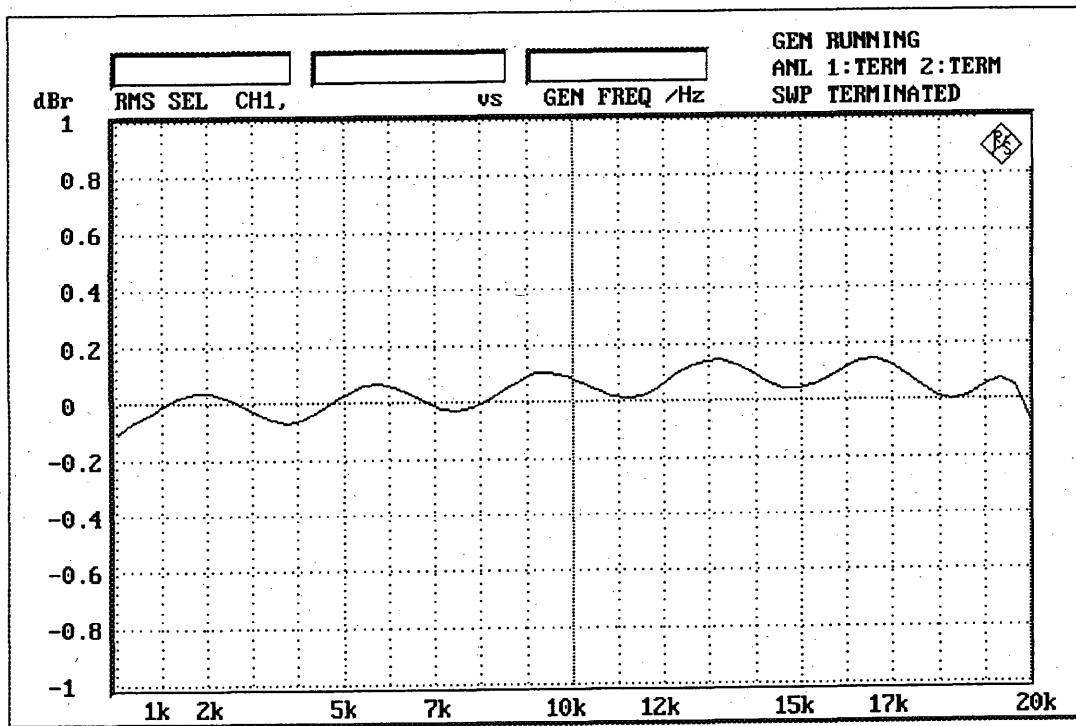

Figure 47 : Frequency response (input level : 0dBFS)

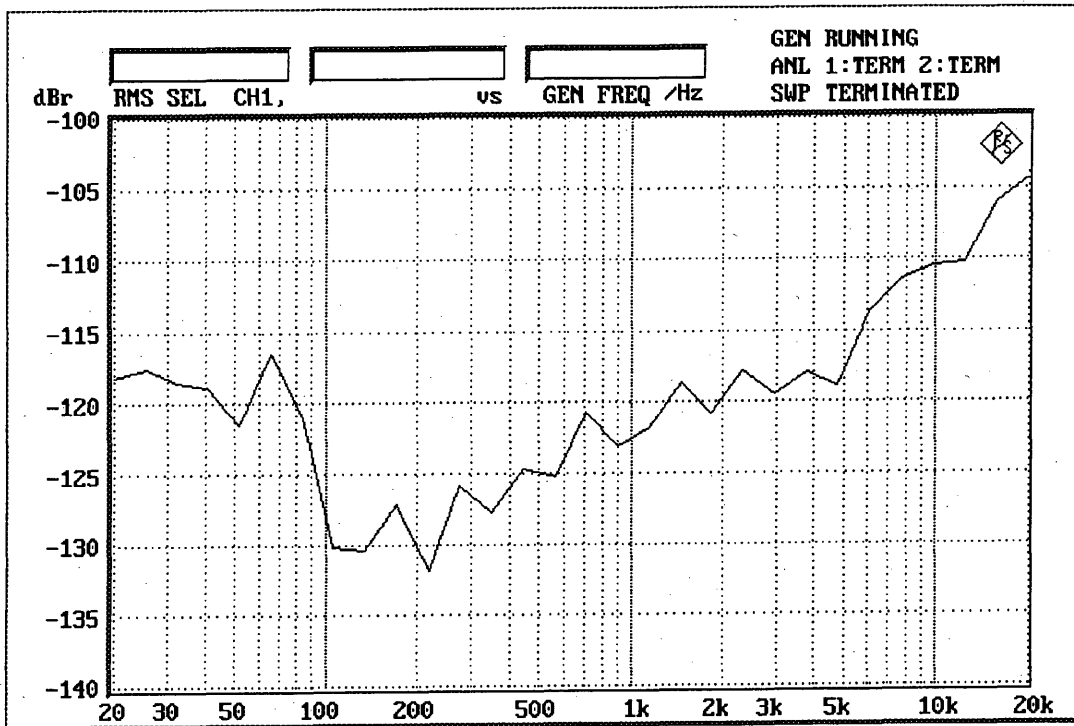

Figure 48 : Cross talk

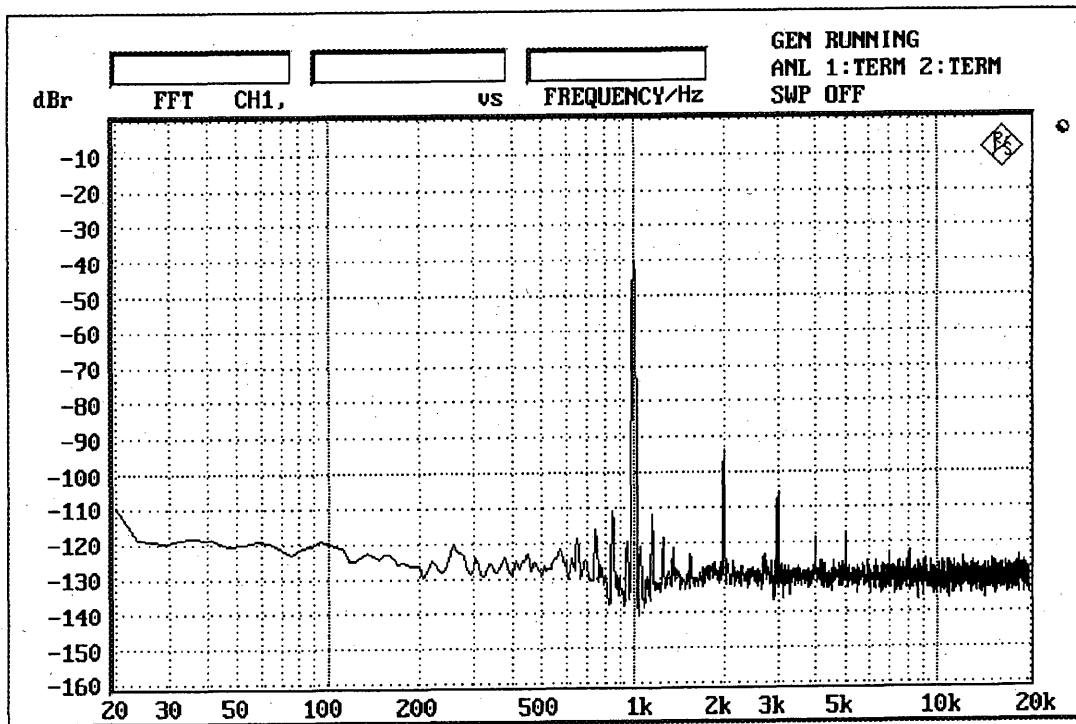

Figure 49 : FFT (input signal : 1kHz, 0dBFS ;

FFT points : 8192, averaging : 10, 30dBFS Notch filter : on)



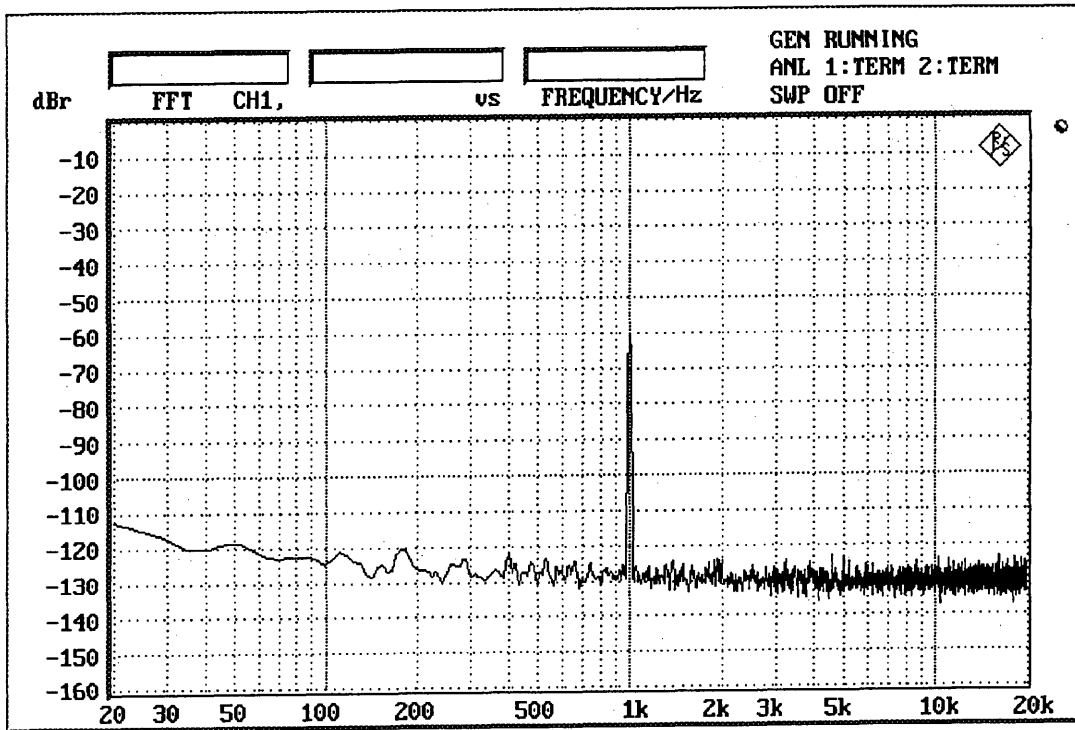

Figure 50 : FFT (input signal : 1kHz, -60dBFS ;

FFT points : 8192, averaging : 10, 30dBFS Notch filter : off)

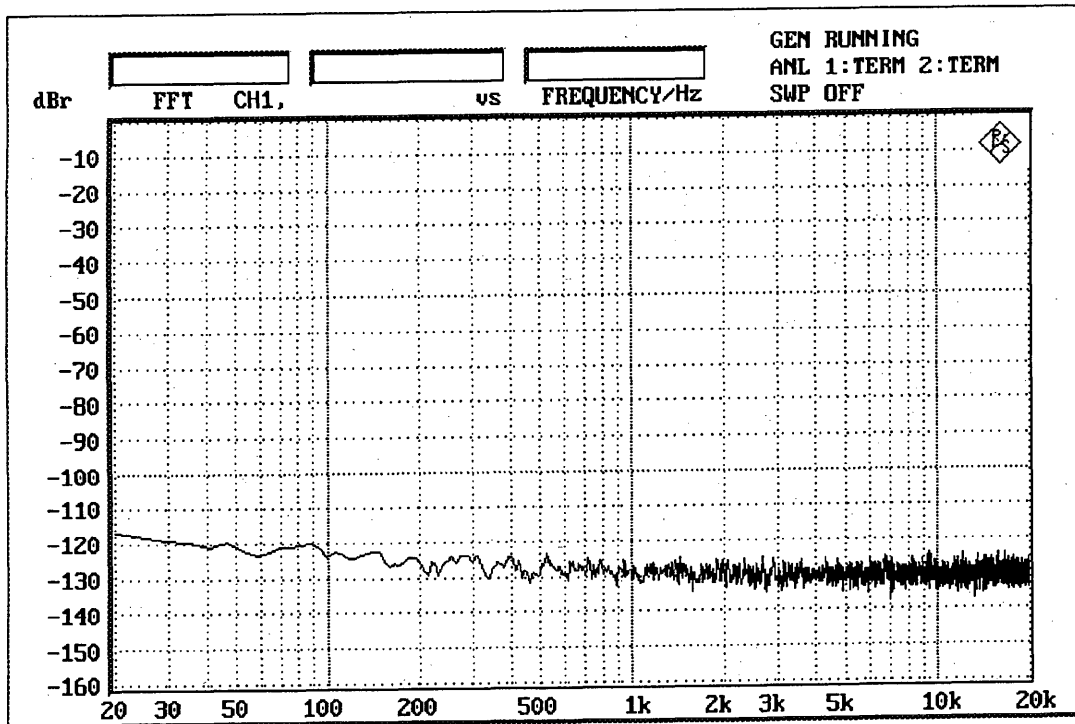

Figure 51 : FFT (noise floor ;

FFT points : 8192, averaging : 10, 30dBFS Notch filter : off)

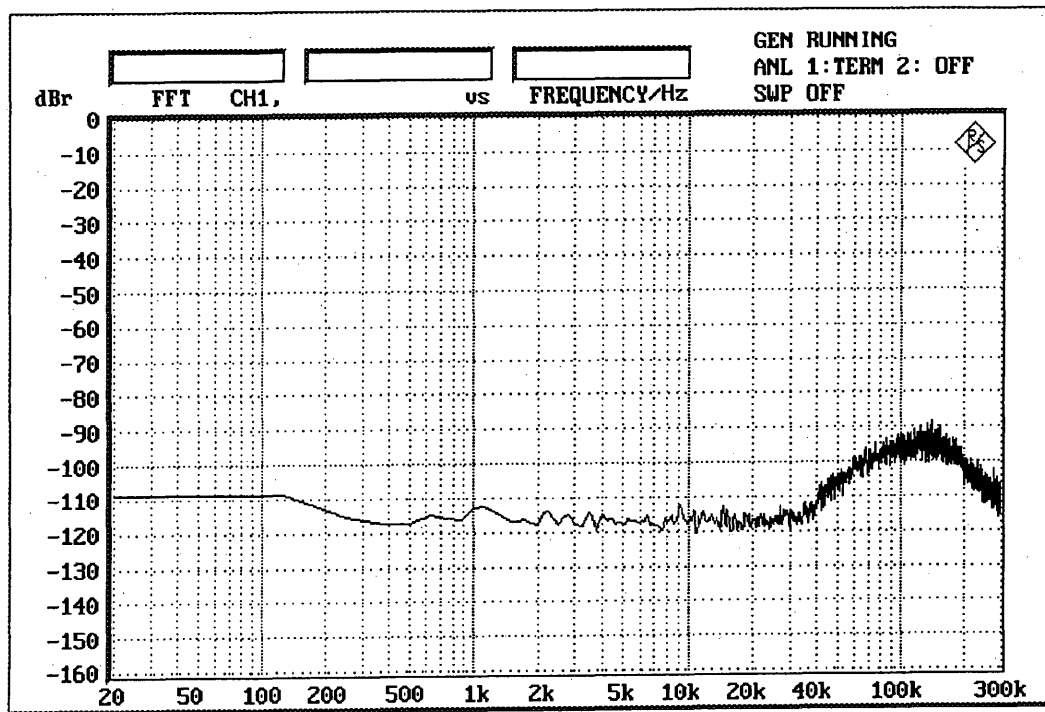
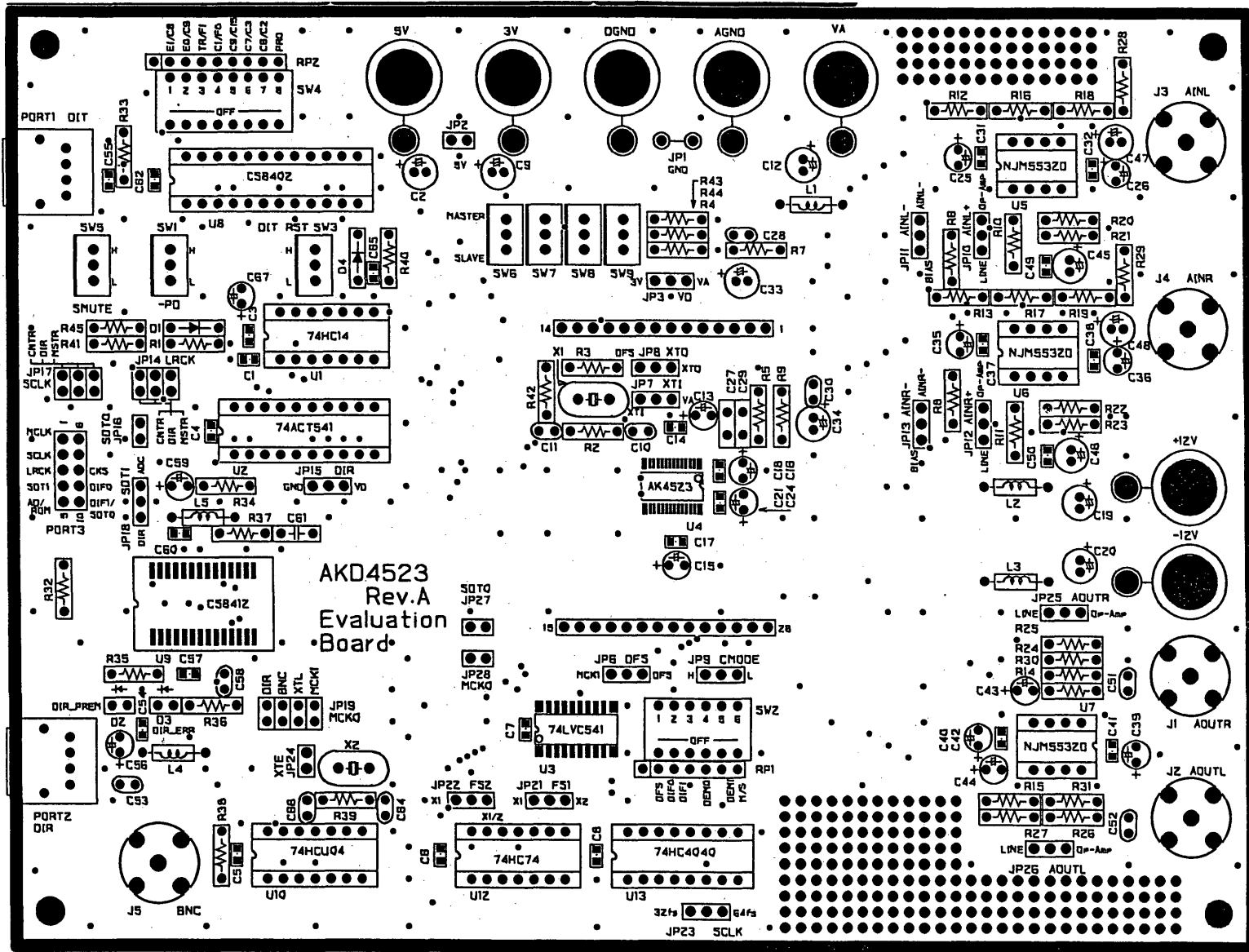
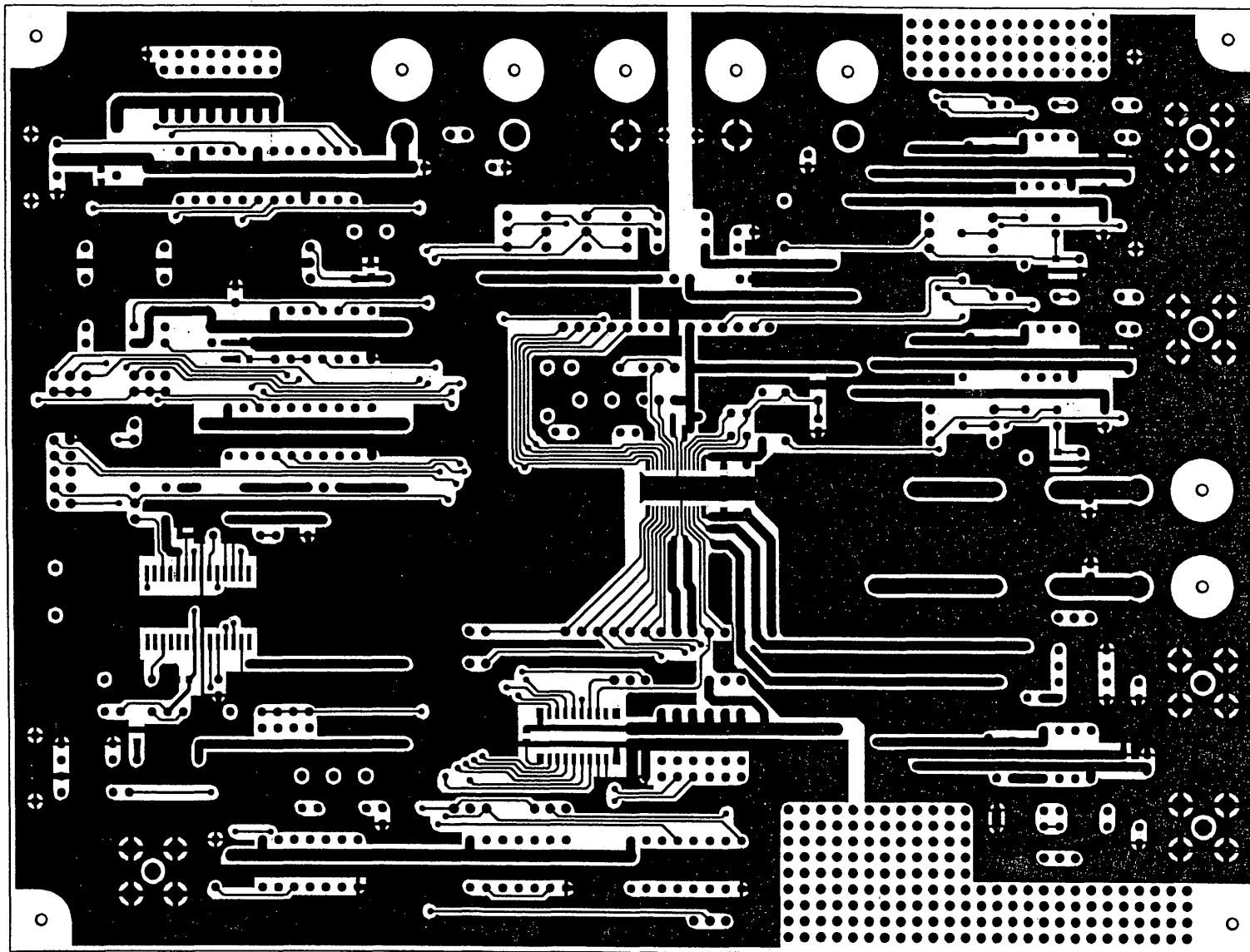

Figure 52 : FFT (out-of-band noise ~300kHz ;

FFT points : 8192, averaging : 10)



L1 部品面 レジスト シルク AKD4523 Rev.A



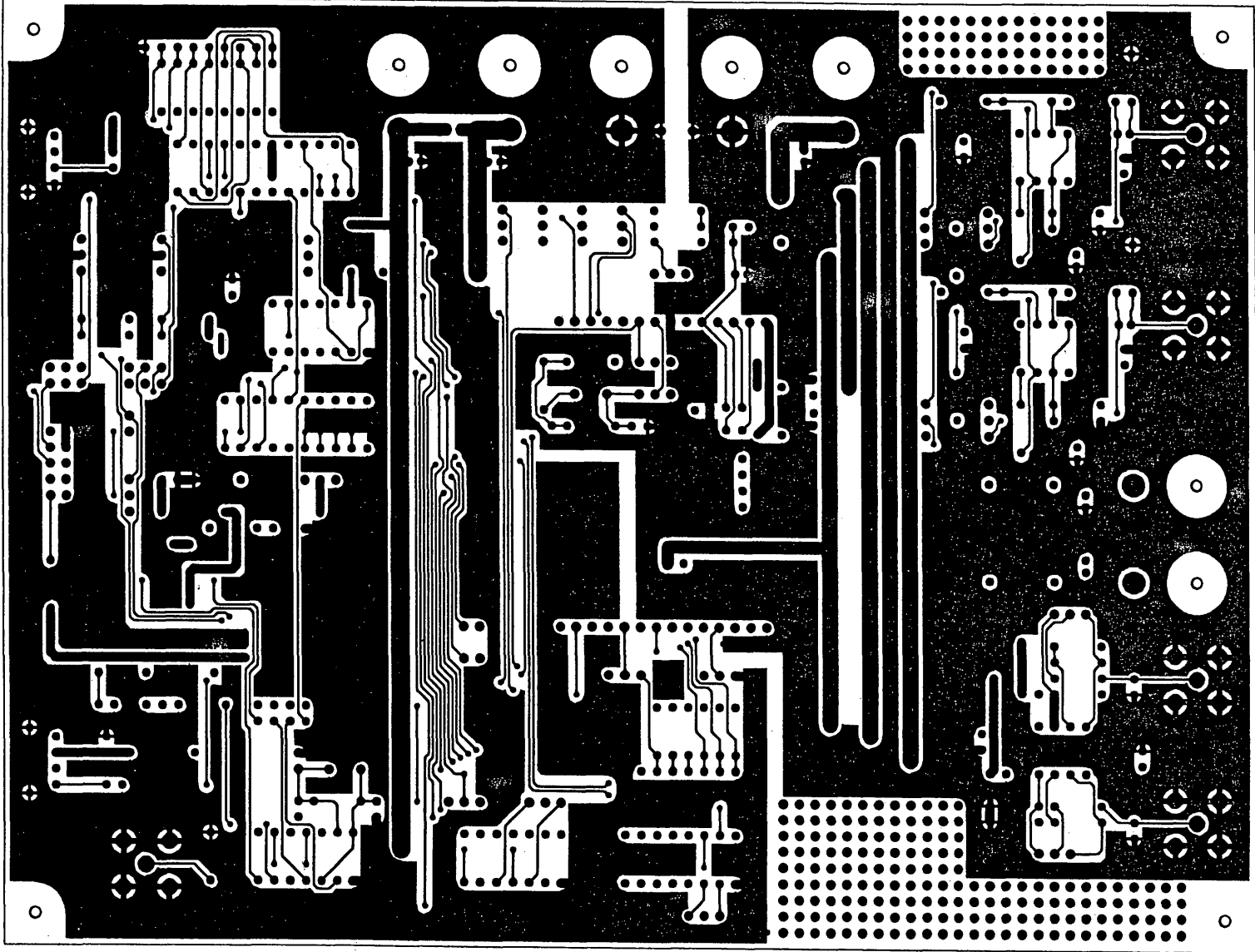

AKD4253 Rev.A

LS 半面 1A-2

## IMPORTANT NOTICE

- These products and their specifications are subject to change without notice. Before considering any use or application, consult the Asahi Kasei Microsystems Co., Ltd. (AKM) sales office or authorized distributor concerning their current status.
- AKM assumes no liability for infringement of any patent, intellectual property, or other right in the application or use of any information contained herein.
- Any export of these products, or devices or systems containing them, may require an export license or other official approval under the law and regulations of the country of export pertaining to customs and tariffs, currency exchange, or strategic materials.
- AKM products are neither intended nor authorized for use as critical components in any safety, life support, or other hazard related device or system, and AKM assumes no responsibility relating to any such use, except with the express written consent of the Representative Director of AKM. As used here:
  - (a) A hazard related device or system is one designed or intended for life support or maintenance of safety or for applications in medicine, aerospace, nuclear energy, or other fields, in which its failure to function or perform may reasonably be expected to result in loss of life or in significant injury or damage to person or property.
  - (b) A critical component is one whose failure to function or perform may reasonably be expected to result, whether directly or indirectly, in the loss of the safety or effectiveness of the device or system containing it, and which must therefore meet very high standards of performance and reliability.
- It is the responsibility of the buyer or distributor of an AKM product who distributes, disposes of, or otherwise places the product with a third party to notify that party in advance of the above content and conditions, and the buyer or distributor agrees to assume any and all responsibility and liability for and hold AKM harmless from any and all claims arising from the use of said product in the absence of such notification.