

T-43-25



AN01

8 Channel Power MOSFET Array Monolithic N-channel Enhancement Mode

Ordering Information

BV _{DSS} / BV _{DGS} (min)	R _{DS(ON)} (max)	I _{D(ON)} (min)	I _{DSS} ** @ V _{DS} = 100V Max	I _{DSS} ** @ V _{DS} = 250V Max	Order Number / Package			
					18-Lead Ceramic DIP	18-Lead Plastic DIP	Plastic SOW-20*	Die
160V	350Ω	25mA	1nA	—	AN0116NB	AN0116NA	AN0116WG	AN0116ND
200V	300Ω	25mA	—	—	AN0120NB	AN0120NA	—	AN0120ND
300V	300Ω	25mA	—	—	AN0130NB	AN0130NA	—	AN0130ND
320V	350Ω	25mA	—	1nA	AN0132NB	AN0132NA	AN0132WG	AN0132ND
400V	350Ω	25mA	—	—	AN0140NB	AN0140NA	AN0140WG	AN0140ND

*Same as SO-20 with 300 mil wide body.

**Average current per channel, measured with all eight channels connected in parallel.

Features

- Low drain to source leakage for AN0116 and AN0132
- 200-volt to 400-volt capability
- Interfaces directly to CMOS logic
- 8 independent channels
- Low crosstalk between channels
- Low power dissipation
- Pin compatible with industry standard driver array
- Freedom from secondary breakdown

General Description

The Supertex AN01 series of high voltage arrays is designed to provide the interface between MOS logic and loads requiring high voltages and intermediate currents. Each circuit consists of eight channels in a common-source configuration with open drains. This design minimizes the number of package leads needed.

The AN0116 and AN0132 are ideally suited for low leakage/high impedance measurement, providing excellent accuracy and resolution for Automatic Test Equipment.

Applications

- High impedance/low leakage measurements for Bare Board Testers
- High voltage piezoelectric transducer drivers
- High voltage electroluminescent panel drivers
- High voltage electrostatic array drivers
- General multi-channel driver array

Absolute Maximum Ratings

Drain-to-Source Voltage	BV _{DSS}
Drain-to-Gate Voltage	BV _{DGS}
Gate-to-Source Voltage	± 20V
Operating and Storage Temperature	-55°C to +150°C
Soldering Temperature*	300°C
Channel-to-Channel Crosstalk	10mV/V

*Distance of 1.6 mm from case for 10 seconds.

T-43-25

AN01

Thermal Characteristics

Package	I_D (continuous)*	I_D (pulsed)*	Power Dissipation @ $T_C = 25^\circ\text{C}$	θ_{JA} $^\circ\text{C/W}$	θ_{JC} $^\circ\text{C/W}$	I_{DR}	I_{DRM}^*
18 lead plastic	30mA	75mA	1.5W	135	83	30mA	75mA
18 lead ceramic	40mA	75mA	2.0W	85	62	40mA	75mA

* I_D (continuous) is limited by max rated T_J .

Electrical Characteristics (@ 25°C unless otherwise specified)

(Notes 1, 2 and 3)

Symbol	Parameter	Min	Typ	Max	Unit	Conditions
BVDSS	Drain-to-Source Breakdown Voltage	AN0116 AN0120 AN0130 AN0132 AN0140	160 200 300 320 400			V $I_D = 100\mu\text{A}, V_{GS} = 0\text{V}$
VGS(th)	Gate Threshold Voltage	2		5	V	$V_{GS} = V_{DS}, I_D = 1\text{mA}$
$\Delta V_{GS}(\text{th})$	Change in $V_{GS}(\text{th})$ with Temperature		-3.5		mV/ $^\circ\text{C}$	$V_{GS} = V_{DS}, I_D = 1\text{mA}$
IGSS	Gate Body Leakage	AN0120 AN0130 AN0140		10	nA	$V_{GS} = \pm 20\text{V}, V_{DS} = 0$
		AN0116 AN0132		1	nA	$V_{GS} = \pm 20\text{V}, V_{DS} = 0$ (Note 3)
IDSS	Zero Gate Voltage Drain Current	AN0120 AN0130 AN0140		1	μA	$V_{GS} = 0, V_{DS} = \text{Max Rating}$
				1	mA	$V_{GS} = 0, V_{DS} = 0.8 \text{ Max Rating}$ $T_A = 125^\circ\text{C}$
		AN0116		1	nA	$V_{GS} = 0, V_{DS} = 100\text{V}$ (Note 3)
				1	mA	$V_{GS} = 0, V_{DS} = 0.8 \text{ Max Rating}$ $T_A = 125^\circ\text{C}$
				1	nA	$V_{GS} = 0, V_{DS} = 250\text{V}$ (Note 3)
				1	mA	$V_{GS} = 0, V_{DS} = 0.8 \text{ Max Rating}$ $T_A = 125^\circ\text{C}$
ID(ON)	ON-State Drain Current	25			mA	$V_{GS} = 10\text{V}, V_{DS} = 25\text{V}$
RDS(ON)	Static Drain-to-Source ON-State Resistance	AN0120 AN0130		300	Ω	$V_{GS} = 10\text{V}, I_D = 10\text{mA}$
		AN0116 AN0132 AN0140		350	Ω	$V_{GS} = 10\text{V}, I_D = 10\text{mA}$
$\Delta R_{DS}(\text{ON})$	Change in $R_{DS}(\text{ON})$ with Temperature		0.8		%/ $^\circ\text{C}$	$V_{GS} = 10\text{V}, I_D = 10\text{mA}$
GFS	Forward Transconductance	4.0	8.0		m Ω	$I_D = 10\text{mA}, \Delta V_{GS} = 1\text{V}$
Ciss	Input Capacitance		5.0	7.5	pF	$V_{DS} = 25\text{V}, V_{GS} = 0$ $f = 1 \text{ MHz}$
COSS	Common Source Output Capacitance		3.0	5.0		
CRSS	Reverse Transfer Capacitance		0.8	1.5		
t _{d(ON)}	Turn-ON Delay Time		3		ns	$V_{DS} = 25\text{V}$ $I_D = 10\text{mA}$ $50\Omega \text{ drive}, V_{GS}(\text{ON}) = 10\text{V}$
t _r	Rise Time		3			
t _{d(OFF)}	Turn-OFF Delay Time		5			
t _f	Fall Time		3			
VSD	Diode Forward Voltage Drop			1.3	V	$V_{GS} = 0, I_{SD} = 50\text{mA}$

Note 1: All D.C. parameters 100% tested at 25°C unless otherwise stated. (Pulse test: 300ms pulse, 2% duty cycle.)

Note 2: All A.C. parameters sample tested.

Note 3: Average current per channel, measured with all 8 channels connected in parallel.

Switching Waveforms and Test Circuit

T-43-25

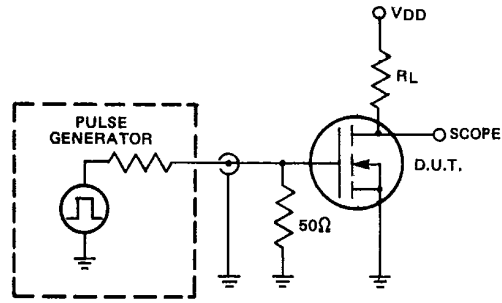
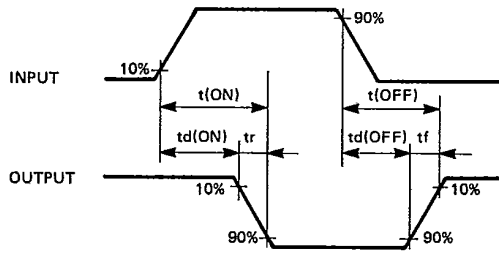

Typical Performance Curves

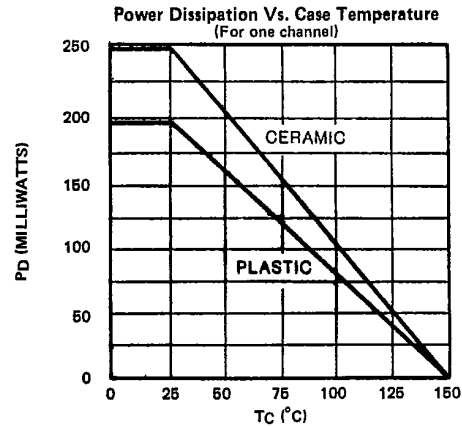
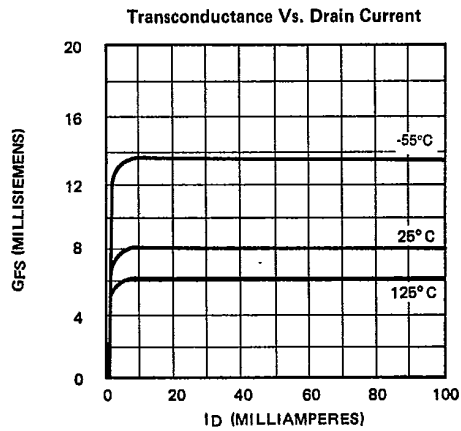
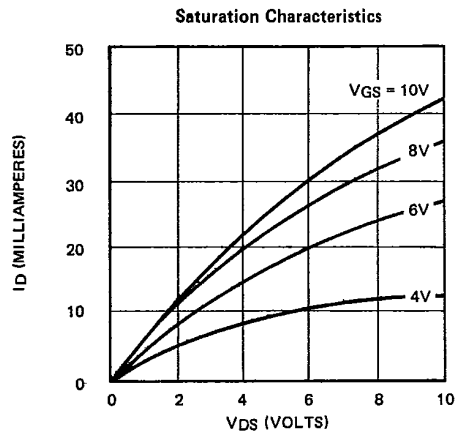
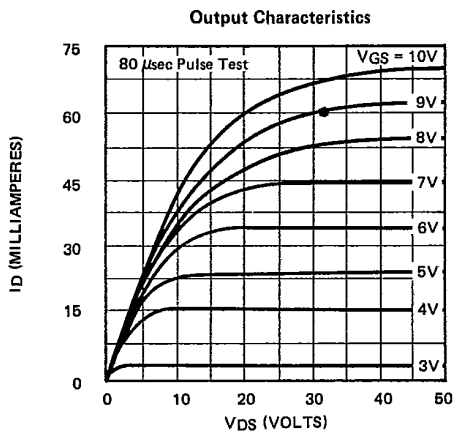

T-43-25

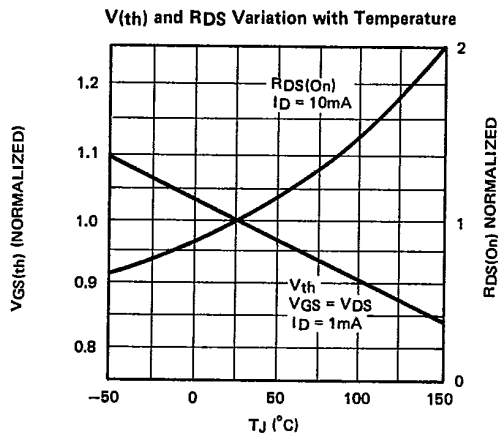
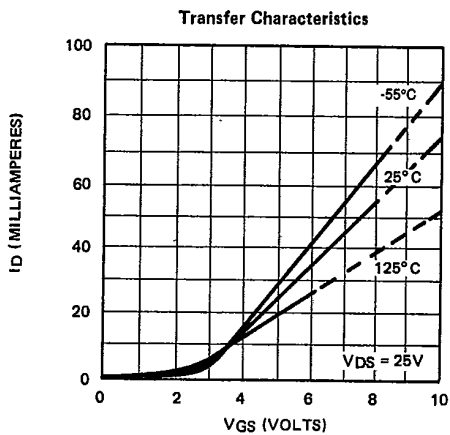
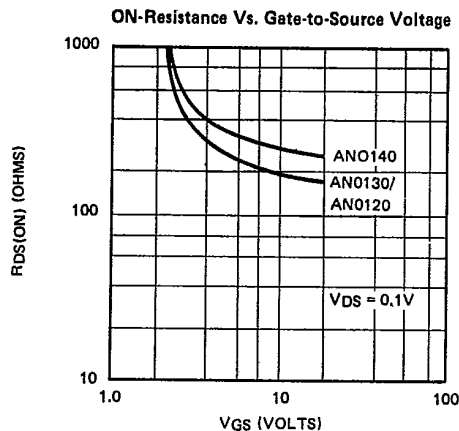
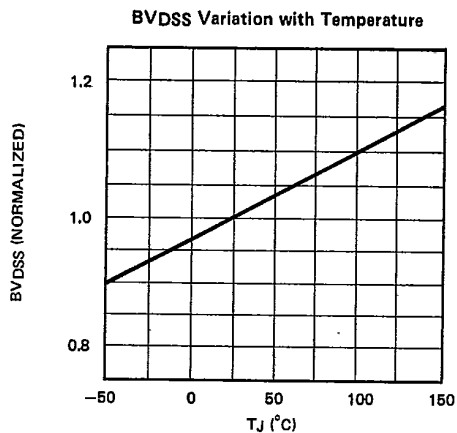
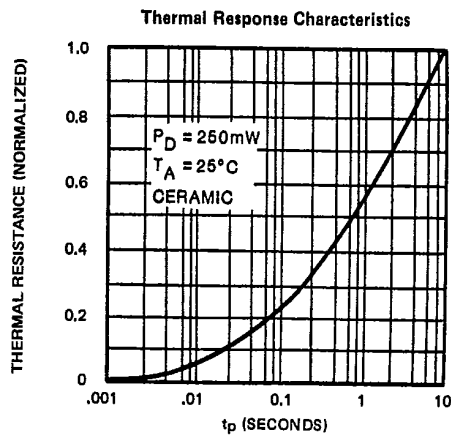
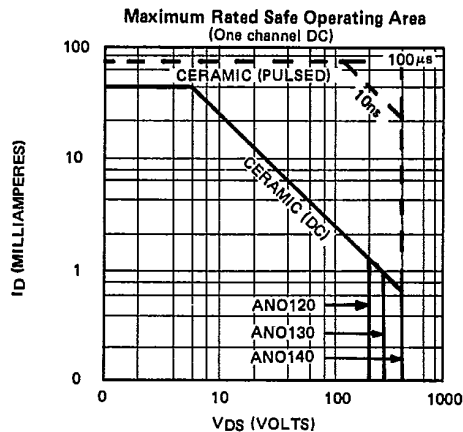

T-43-25

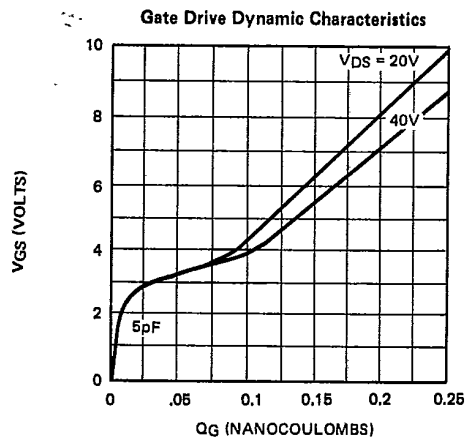
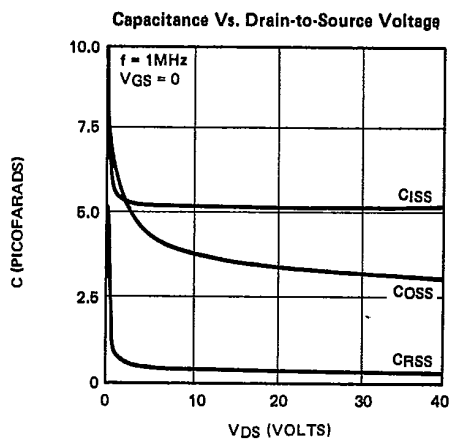

Pin Configuration and Schematic

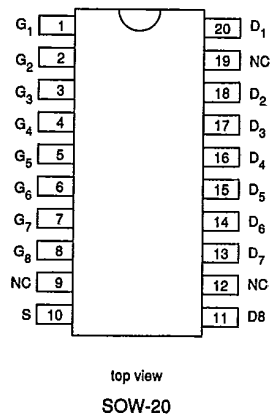
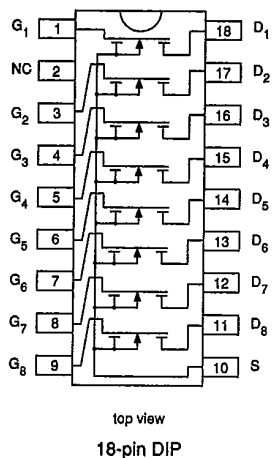

10