

AN3358SH

2-head recording and playback amplifier IC for 8 mm video camera

■ Overview

The AN3358SH is a recording and playback amplifier IC for 8 mm video camera of 2-head large diameter cylinder, and encapsulated in a small SO package of 24 pins and 0.5 mm pitch.

■ Features

- 2-channel playback head amp
- 2-channel recording amp (collector open type with a single pin output)
- RF-AGC
- Pulse generator for drop out compensation (DOC)
- Supply voltage: 5 V ± 0.5 V
- Small SO package of 0.5 mm pitch (SSOP-24D)

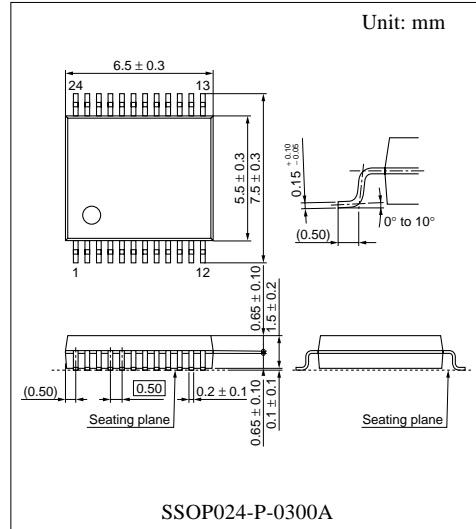

■ Applications

- 8 mm video camera

■ Block Diagram

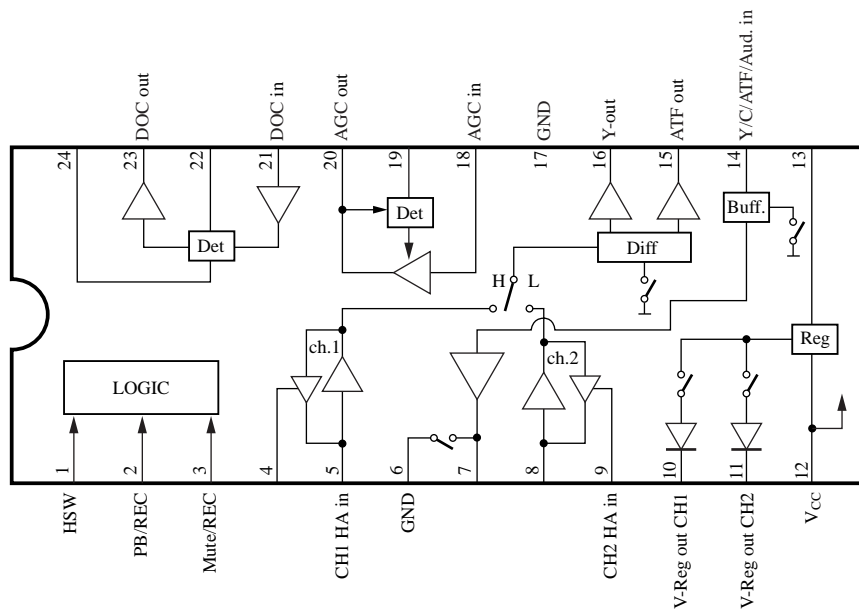

■ Pin Descriptions

Pin No.	Description	Pin No.	Description
1	HSW changeover pin	13	Capacitor pin for V-Reg.
2	PB/REC changeover pin	14	REC curr. amp. input pin
3	Mute/REC changeover pin	15	ATF output pin
4	ch.1 head amp. damping pin	16	Y-output pin
5	ch.1 head amp. input pin	17	Main GND
6	Small signal GND	18	AGC input pin
7	REC curr. amp. output pin	19	AGC det pin
8	ch.2 head amp. input pin	20	AGC output pin
9	ch.2 head amp. damping pin	21	DOC input pin
10	V-reg out.ch.2 pin	22	DOC det pin
11	V-reg out.ch.1 pin	23	DOC output pin
12	Main V_{CC}	24	DOC level control pin

■ Absolute Maximum Ratings

Parameter	Symbol	Rating	Unit
Supply voltage	V_{CC}	6	V
Supply current	I_{CC}	—	mA
Power dissipation *2	P_D	201	mW
Operating ambient temperature*1	T_{opr}	-20 to +70	°C
Storage temperature*1	T_{stg}	-55 to +125	°C

Note) *1: Except for the operating ambient temperature and storage temperature, all ratings are for $T_a = 25^\circ\text{C}$.

*2: The power dissipation shown is for the IC package in free air at $T_a = 70^\circ\text{C}$.

■ Recommended Operating Range

Parameter	Symbol	Range	Unit
Supply voltage	V_{CC}	4.5 to 5.5	V

■ Electrical Characteristics at $T_a = 25^\circ\text{C}$

Parameter	Symbol	Conditions	Min	Typ	Max	Unit
REC circuit current	I_{12REC}	$V_{CC} = 5\text{ V}$	29	(41)	53	mA
Recording current output	I_7	$V_{CC} = 5\text{ V}, V_{IN} = 200\text{ mV[p-p]},$ $f = 5\text{ MHz}$	31	(44)	57	mA[p-p]
PB/REC REC mode hold voltage	V_{2REC}	$V_{CC} = 5\text{ V}$, pin 2 potential measurement	0	—	1.5	V
Mute/REC REC mode hold voltage	V_{3REC}	$V_{CC} = 5\text{ V}$, pin 3 potential measurement	0	—	1.5	V
Mute/REC Mute mode hold voltage	V_{3Mute}	$V_{CC} = 5\text{ V}$, pin 3 potential measurement	3.5	—	5	V
PB circuit current	I_{12PB}	$V_{CC} = 5\text{ V}$	12	(17)	22	mA

■ Electrical Characteristics at $T_a = 25^\circ\text{C}$ (continued)

Parameter	Symbol	Conditions	Min	Typ	Max	Unit
HSW DC unbalance	HSW	$V_{CC} = 5\text{ V}$	—	—	100	mV[p-p]
ch.1 gain	G_{5-16}	$V_{CC} = 5\text{ V}$, pin 5 input: $V_{IN} = 0.3\text{ mV[p-p]}$ $f = 5\text{ MHz}$	60	(64)	68	dB
ch.2 gain	G_{8-16}	$V_{CC} = 5\text{ V}$, pin 8 input: $V_{IN} = 0.3\text{ mV[p-p]}$ $f = 5\text{ MHz}$	60	(64)	68	dB
Y-output/ATF output gain ratio	G_{5-16} $-G_{5-15}$	$V_{CC} = 5\text{ V}$, pin 5 input: $V_{IN} = 0.3\text{ mV[p-p]}$ $f = 5\text{ MHz}$	-2	(0)	2	dB
Input-referred noise ch.1	N_{5-16}/G_{5-16}	$V_{CC} = 5\text{ V}$, 1 MHz BPF output is divided by gain	—	—	1	$\mu\text{V[rms]}$
Input-referred noise ch.2	N_{8-16}/G_{8-16}	$V_{CC} = 5\text{ V}$, 1 MHz BPF output is divided by gain	—	—	1	$\mu\text{V[rms]}$
ATF output DC voltage	V_{15}	$V_{CC} = 5\text{ V}$	1.9	(2.3)	2.7	V
Y-output DC voltage	V_{16}	$V_{CC} = 5\text{ V}$	1.9	(2.3)	2.7	V
PB/REC PB mode hold voltage	V_{2PB}	$V_{CC} = 5\text{ V}$, pin 2 potential measurement	3.5	—	5	V
HSW high-level hold voltage	V_{1H}	$V_{CC} = 5\text{ V}$, pin 1 potential measurement	3.5	—	5	V
HSW low-level hold voltage	V_{1L}	$V_{CC} = 5\text{ V}$, pin1 potential measurement	0	—	1.5	V
AGC output amplitude	V_{18-20}	$V_{CC} = 5\text{ V}$, $V_{IN} = 500\text{ mV[p-p]}$, $f = 5\text{ MHz}$	280	(400)	520	mV[p-p]
AGC sensitivity	ΔV_{18-20}	$V_{CC} = 5\text{ V}$, $f = 5\text{ MHz}$ $V_{IN} = 500\text{ mV[p-p]} \pm 6\text{ dB}$	—	—	3	dB
AGC output DC voltage	V_{20}	$V_{CC} = 5\text{ V}$	2.05	(2.45)	2.85	V
Drop-out detection on level	V_{21ON}	$V_{CC} = 5\text{ V}$, $f = 5\text{ MHz}$, $V_{IN} = 400\text{ mV[p-p]} \rightarrow 0$	-16.0	(-12.5)	-10.5	dB
Drop-out detection off level	V_{21OFF}	$V_{CC} = 5\text{ V}$, $f = 5\text{ MHz}$, $V_{IN} = 0 \rightarrow 400\text{ mV[p-p]}$	-9.5	(-7.5)	-5.5	dB
Drop-out pulse low-level	V_{23L}	$V_{CC} = 5\text{ V}$, $V_{IN} = 400\text{ mV[p-p]}$, $f = 5\text{ MHz}$	—	(0)	0.5	V
Drop-out pulse high-level	V_{23H}	$V_{CC} = 5\text{ V}$	2.8	(3.2)	3.6	V
Recording current secondary harmonic distortion *	D_{2f}	$V_{CC} = 5\text{ V}$, $V_{IN} = 200\text{ mV[p-p]}$, $f = 5\text{ MHz}$	—	-45	—	dB
Recording current frequency characteristics ratio *	I_{7H}/I_Z	$V_{CC} = 5\text{ V}$, $f = 10\text{ MHz}$, 5 MHz $V_{IN} = 200\text{ mV[p-p]}$	—	0	—	dB
PB frequency characteristics ratio*	V_{16H}/V_{16}	$V_{CC} = 5\text{ V}$, $f = 10\text{ MHz}$, 5 MHz $V_{IN} = 0.3\text{ mV[p-p]}$	—	-3	—	dB

Note) The standard values in the parenthesis are the typical values and not the guaranteed ones.





■ Terminal Equivalent Circuits

Pin No.	Equivalent Circuit	Description	Pin Voltage	Remark
1		HSW changeover pin	High: ch.1 output (Pin 5 input) Low: ch.2 output (Pin 8 input)	Set the outputting channel by pin 1. Ch.1 is outputted at open.
2		PB/REC changeover pin	High: PB Low: REC (or mute)	PB and REC modes are changed by pin 2. PB mode at open. Select mute or REC by pin 3.
3		Mute/REC changeover pin	High: mute Low: REC	Select mute or REC by pin 3. Mute mode at open.
4		ch.1 head amp. damping pin	REC — 2.1 V Mute — 1.4 V PB — 1.4 V	—
5		ch.1 head amp. input pin	REC — GND Mute — 0.7 V PB — 0.7 V	—

■ Terminal Equivalent Circuits (continued)

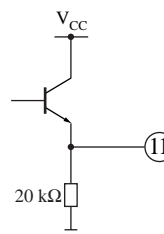
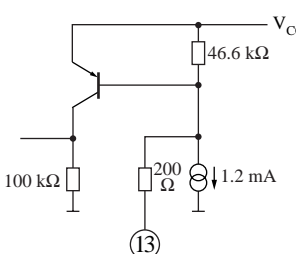
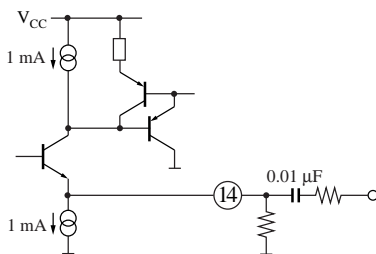
Pin No.	Equivalent Circuit	Description	Pin Voltage	Remark
6	—	Small signal GND	—	—
7		REC curr. amp. output pin	REC 4 V Mute — GND PB — GND	—
8		ch.2 head amp. input pin	REC — GND Mute — 0.7 V PB 0.7 V	—
9		ch.2 head amp. damping pin	REC — 2.1 V Mute — 1.4 V PB — 1.4 V	—
10		V-reg out ch.2 pin	REC — 4.2 V Mute — GND PB — GND	—

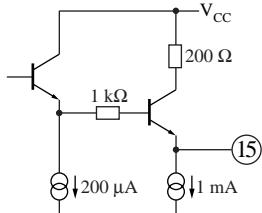
■ Terminal Equivalent Circuits (continued)

Pin No.	Equivalent Circuit	Description	Pin Voltage	Remark
11		V-reg out ch.1 pin	REC — 4.2 V Mute — GND PB — GND	—
12	—	Main V _{CC}	—	—
13		For V-reg capacitor pin	REC — 4.2 V Mute — 5 V PB — 5 V	—
14		REC curr. amp. input pin	REC  1.6 V Mute  1.6 V PB — GND	—
15		ATF output pin	REC — 4.1 V Mute — 4.1 V PB  2.3 V	—

■ Terminal Equivalent Circuits (continued)

Pin No.	Equivalent Circuit	Description	Pin Voltage	Remark
16		Y-output pin	REC ——— 4.1 V Mute ——— 4.1 V PB 2.3 V	—
17	—	Main GND	—	—
18		AGC input pin	REC ——— 2.4 V Mute ——— 2.4 V PB 3 V	—
19		AGC det. pin	REC ——— 3.2 V Mute ——— 2.9 V PB 2.9 V	—
20		AGC output pin	REC ——— 4.4 V Mute ——— 4.4 V PB 2.45 V	—

■ Terminal Equivalent Circuits (continued)

Pin No.	Equivalent Circuit	Description	Pin Voltage	Remark
21		DOC input pin	—	—
22		DOC det. pin	REC ——— 4.4 V Mute ——— 4.4 V PB 2.4 V	—
23		DOC output pin	REC ——— GND Mute ——— GND PB 3.2 V GND	—
24		DOC level control pin	REC ——— 2.25 V Mute ——— 2.25 V PB ——— 2.25 V	—

■ Application Circuit Example

