

AN7174K

Dual BTL 14W Audio Power Amplifier Circuit

■ Overview

The AN7174K is an integrated circuit for 14W (13.2V, 4Ω) output power amplifier circuit. Two BTL amplifiers are built-in on a single chip and stereo operation is possible. It is highly reliable due to protection circuits built-in. The built-in stand-by circuit makes it possible to switch the circuit ON/OFF with a charge mode to power supply pin.

■ Features

- High output power (BTL 14W × 2)
- Stand-by circuit built-in
- Protection circuits built-in (temperature, overvoltage, V_{OUT} -GND short, Load short, V_{OUT} - V_{CC} short)
- Low shock noise from power ON/OFF operation
- Fewer external parts
- Highly stable operation

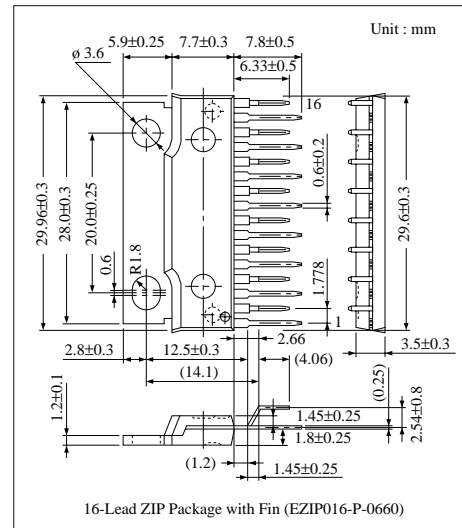

■ Block Diagram

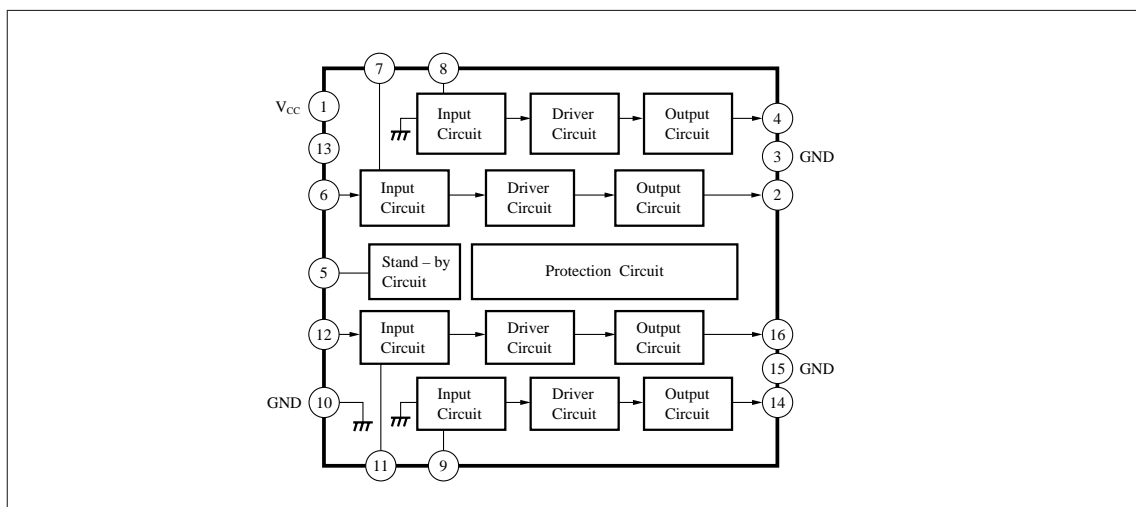

■ Absolute Maximum Ratings (Ta= 25°C)

Parameter	Symbol	Rating	Unit
Supply Voltage <small>Note 1)</small>	V _{CC}	24	V
Peak Supply Voltage <small>Note 2)</small>	V _{CC(surge)}	50	V
Supply Current	I _{CC}	6	A
Power Dissipation <small>Note 3)</small>	P _D	62.5	W
Operating Ambient Temperature	T _{opr}	- 30 ~ + 75	°C
Storage Temperature	T _{stg}	- 55 ~ + 150	°C

Note 1) No Signal

Note 2) Time= 0.2s

Note 3) R_{θj-c} = 2°C/W

■ Recommended Operating Range (Ta = 25°C)

Parameter	Symbol	Range
Operating Supply Voltage Range	V _{CC}	8V ~ 18V

■ Electrical Characteristics (V_{CC} = 13.2V, R_L = 4Ω, f = 1kHz, Ta = 25°C)

Parameter	Symbol	Condition	min.	typ.	max.	Unit
Quiescent Circuit Current	I _{CQ}	V _{in} = 0mV	—	120	200	mA
Output Noise Voltage	V _{no} *	V _{in} = 0mV, R _g = 10kΩ	—	0.6	1.5	mV
Voltage Gain	G _V	V _{in} = 5mV	50.5	52.5	54.5	dB
Total Harmonic Distortion	THD	V _{in} = 5mV	—	0.2	0.75	%
Maximum Output Power (4Ω)	P _O	THD = 10%	9	12.5	—	W
Ripple Rejection Ratio	RR *	R _g = 0Ω, V _{in} = 0mV, Ripple = 300mV, 120Hz	35	40	—	dB
Output Offset Voltage	V _{O(offset)}	V _{in} = 0mV	-300	0	300	mV
Channel Balance	CB	V _{in} = 5mV	-1	0	1	dB
Total Harmonic Distortion	THD	V _{in} = 5mV, 100Hz	—	0.26	—	%
Total Harmonic Distortion	THD	V _{in} = 5mV, 10kHz	—	0.45	—	%
Frequency Characteristics	f _{CH}	V _{in} = 5mV, -3dB down	—	22	—	kHz
Frequency Characteristics	f _{CL}	V _{in} = 5mV, -3dB down	—	21	—	Hz
Quiescent Circuit Current at Stand-by Pin	I _{CQ(STBY-ON)}	Stand-by Pin ON	—	21	—	μA
Crosstalk	CT	V _{in} = 5mV, R _g = 10kΩ	—	61	—	dB

* With 15Hz ~ 30kHz (12dB/oct) filter

■ Characteristics Curve

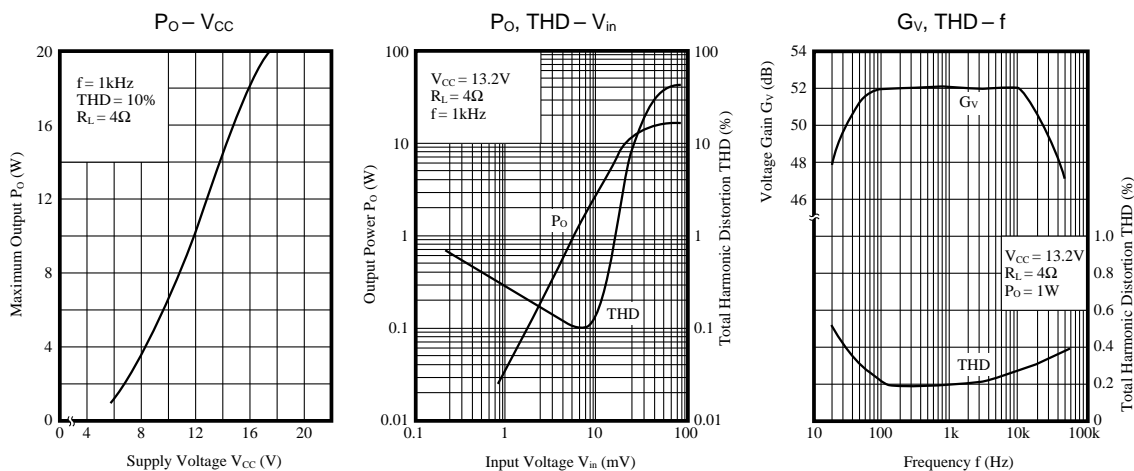

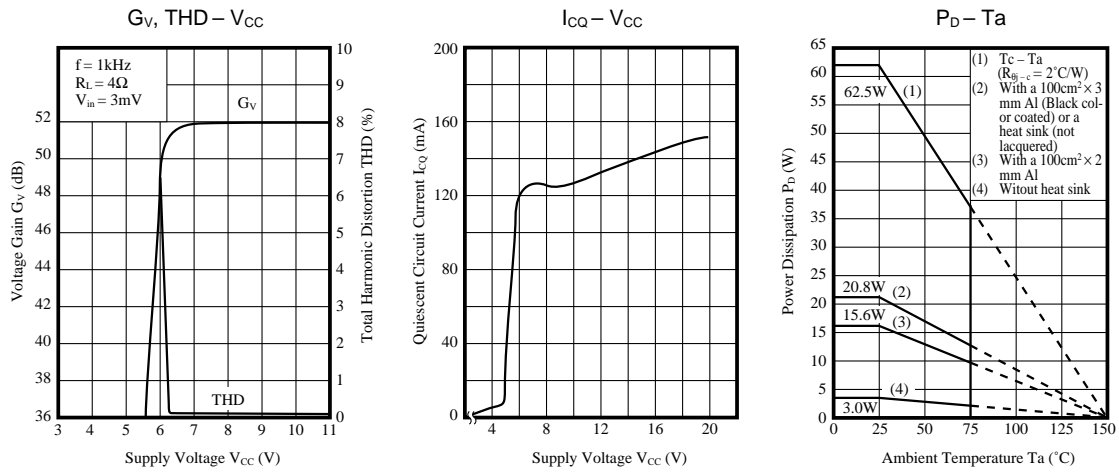

■ Application Circuit

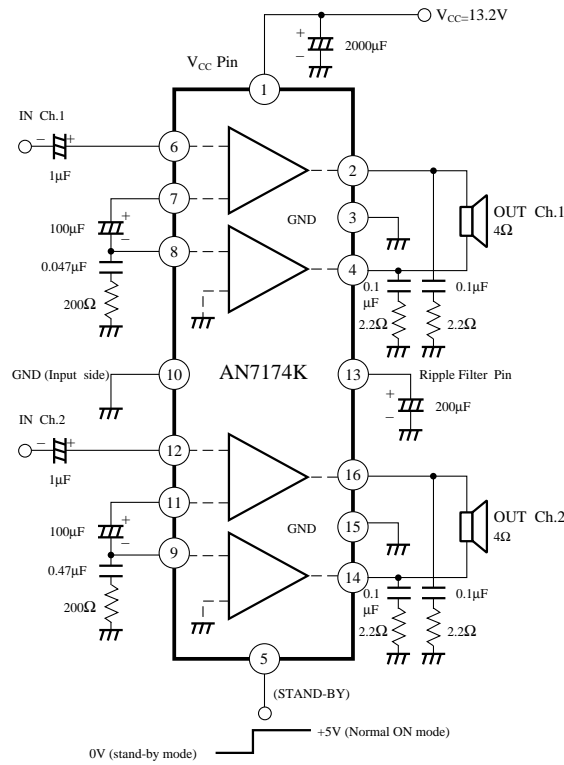

Note) 300mV, 120Hz ripple component should be applied at the measurement of ripple rejection ratio.

■ Pin Descriptions

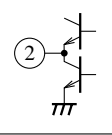
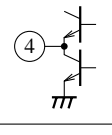
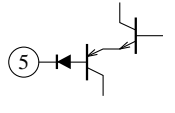
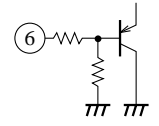
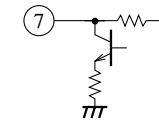
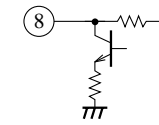
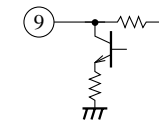
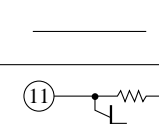
Pin No.	Pin Name	Description	Equivalent Circuit
1	Supply Pin	Supply connection pin	—————
2	Output Ch.1	Ch.1 positive-phase output pin	
3	GND (Output Ch.1)	GND pin for Ch.1 output	—————
4	Output Ch.1	Ch.1 reverse-phase output pin	
5	Stand-by	Circuit mode (stand-by ↔ operation) switching pin	
6	Input Ch.1	Ch.1 input signal applied pin	
7	Negative Feedback Ch.1	Ch.1 negative feedback pin (+)	
8	Negative Feedback Ch.1	Ch.1 negative feedback pin (-)	
9	Negative Feedback Ch.2	Ch.2 negative feedback pin (-)	
10	GND (Input)	GND pin for input signal source	—————
11	Negative Feedback Ch.2	Ch.2 negative feedback pin (+)	

■ Pin Descriptions (Cont.)

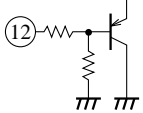
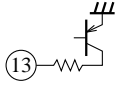
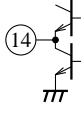
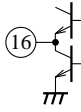
Pin No.	Pin Name	Description	Equivalent Circuit
12	Input Ch.2	Ch.2 input signal applied pin	
13	Ripple Filter	Supply ripple rejection pin	
14	Output Ch.2	Ch.2 reverse-phase output pin	
15	GND (Output Ch.2)	GND pin for Ch.2 output	—
16	Output Ch.2	Ch.2 positive-phase output pin	

■ Precautions on use

1. Thermal breaking protection
The protective operation starts at the chip temperature of $150^{\circ}\text{C}\pm 5^{\circ}\text{C}$.
2. Overvoltage protection
The protective operation starts at $V_{\text{CC}} - 26\text{V}$.
3. Ground fault protection
The protective operation starts when the contact resistance dropped below 0.3Ω .
4. Load shortcircuit protection
The protective operation starts when the contact resistance dropped below 0.3Ω .
5. Atmospheric fault protection
The protective operation starts only when a shortcircuit between pins occurred.
6. TAB shortcircuit
Even TAB short-circuiting with the GND potential causes no breaking trouble.
7. The operation remains normal even when the load is 2Ω .
8. When the chip temperature abnormally rose, the temperature protection circuit gets actuated, but it is automatically reset when the chip temperature dropped below the set level.