

**2A DDR TERMINATION REGULATOR****AP2302L****General Description**

The AP2302L linear regulator is designed to meet the JEDEC specification SSTL-2 and SSTL-18 for termination of DDR-SDRAM. The regulator can sink or source up to 2A current continuously, providing enough current for most DDR applications. V_{OUT} is designed to track the V_{REF} voltage within a $\pm 20mV$ tolerance over the entire current range while preventing shooting through on the output stage. On-chip thermal limiting provides protection against a combination of high current and ambient temperature which would create an excessive junction temperature.

The AP2302L, used in conjunction with series termination resistors, provides an excellent voltage source for active termination schemes of high speed transmission lines as those seen in high speed memory buses and distributed backplane designs.

The AP2302L is available in SOIC-8 and TO-252-5 packages.

Features

- Support Both DDR I ($1.25V_{TT}$) and DDR II ($0.9V_{TT}$) Requirements
- Source and Sink Current up to 2A
- High Accuracy Output Voltage at Full-load
- Adjustable V_{OUT} by External Resistors
- Shutdown for Standby or Suspend Mode Operation with High-impedance Output

Applications

- DDR-SDRAM Termination
- DDR-II Termination
- SSTL-2 Termination

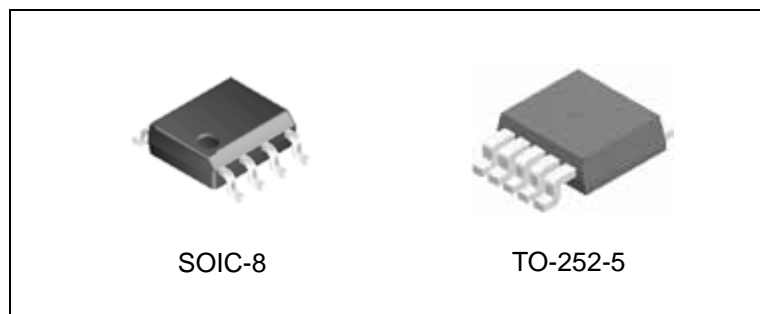

Figure 1. Package Types of AP2302L



2A DDR TERMINATION REGULATOR

AP2302L

Pin Configuration

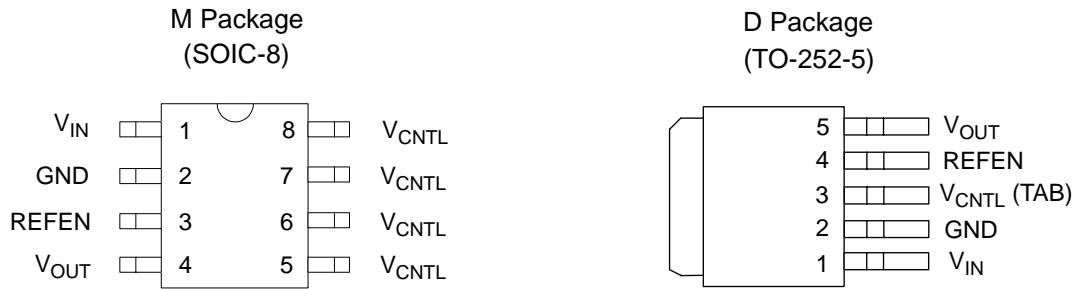

Figure 2. Pin Configuration of AP2302L (Top View)

Pin Description

Pin Number		Pin Name	Function
SOIC-8	TO-252-5		
1	1	V_{IN}	Power Input.
2	2	GND	Ground.
3	4	REFEN	Reference Voltage Input and Chip Enable.
4	5	V_{OUT}	Output Voltage.
5, 6, 7, 8	3	V_{CNTL}	Supply Voltage for Internal Circuit (Internally Connected for SOIC-8), (TAB for TO-252-5).



2A DDR TERMINATION REGULATOR

AP2302L

Functional Block Diagram

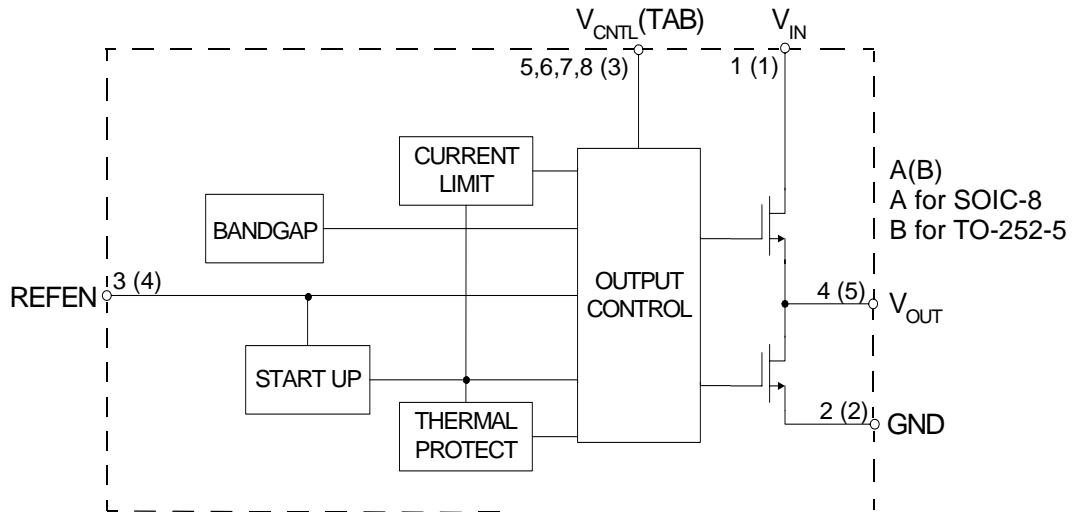
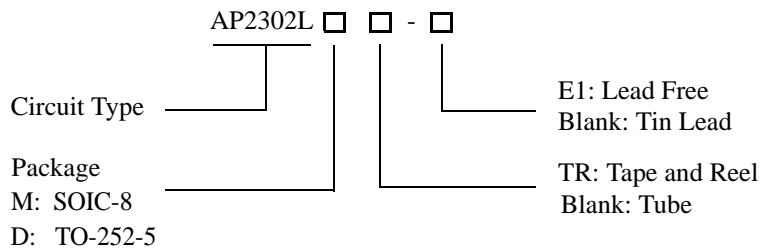

Figure 3. Functional Block Diagram of AP2302L

Ordering Information



Package	Temperature Range	Part Number		Marking ID		Packing Type
		Tin Lead	Lead Free	Tin Lead	Lead Free	
SOIC-8	0 to 125°C		AP2302LM-E1		2302LM-E1	Tube
			AP2302LMTR-E1		2302LM-E1	Tape & Reel
TO-252-5	0 to 125°C		AP2302LD-E1		AP2302LD-E1	Tube
			AP2302LDTR-E1		AP2302LD-E1	Tape & Reel

BCD Semiconductor's Pb-free products, as designated with "E1" suffix in the part number, are RoHS compliant.

**2A DDR TERMINATION REGULATOR****AP2302L****Absolute Maximum Ratings (Note 1)**

Parameter	Symbol	Value		Unit
Supply Voltage for Internal Circuit	V_{CNTL}	7		V
Power Dissipation	P_D	Internally Limited		W
ESD (Human Body Model)	ESD	2		KV
Storage Temperature Range	T_{STG}	-65 to 150		°C
Lead Temperature (Soldering, 5sec)	T_{LEAD}	260		°C
Package Thermal Resistance (Free Air)	θ_{JC}	SOIC-8	28	°C/W
		TO-252-5	13	

Note 1: Stresses greater than those listed under "Absolute Maximum Ratings" may cause permanent damage to the device. These are stress ratings only, and functional operation of the device at these or any other conditions beyond those indicated under "Recommended Operating Conditions" is not implied. Exposure to "Absolute Maximum Ratings" for extended periods may affect device reliability.

Recommended Operating Conditions

Parameter	Symbol	Min	Typ	Max	Unit
Supply Voltage for Internal Circuit	V_{CNTL} (Note 2, 3)		3.3	6	V
Power Input	DDR I	1.6	2.5	V_{CNTL}	V
	DDR II		1.8		
Junction Temperature	T_J	0		125	°C

Note 2: Keep $V_{CNTL} \geq V_{IN}$ in operation power on and power off sequences.

Note 3: For safe operation, V_{CNTL} MUST be tied to 3.3V rather than 5V.



2A DDR TERMINATION REGULATOR

AP2302L

Electrical Characteristics

($T_A=25^{\circ}\text{C}$, $V_{IN}=2.5\text{V}$, $V_{CNTL}=3.3\text{V}$, $V_{REFEN}=1.25\text{V}$, $C_{OUT}=10\mu\text{F}$ (Ceramic), unless otherwise specified.)

Parameter	Symbol	Conditions	Min	Typ	Max	Unit
Output Offset Voltage	V_{OS}	$I_L=0\text{A}$ (Note 4)	-20	0	20	mV
Load Regulation	DDR I	$I_L=0$ to 2A	-20	0	20	mV
		$I_L=0$ to -2A				
	DDR II	$I_L=0$ to 2A	-20	0	20	
		$I_L=0$ to -2A				
Quiescent Current of V_{CNTL}	I_Q	No Load		3	5	mA
Leakage Current in Shutdown Mode	I_{SHDN}	$V_{REFEN}<0.2\text{V}$, $R_L=180\Omega$		3	6	μA
Protection						
Current Limit	I_{LIMIT}		2.6			A
Thermal Shutdown Temperature	T_{SHDN}	$3.3\text{V} \leq V_{CNTL} \leq 5\text{V}$		150		$^{\circ}\text{C}$
Thermal Shutdown Hysteresis				50		$^{\circ}\text{C}$
Shutdown Function						
Shutdown Threshold Trigger		Output=High	0.8			V
		Output=Low			0.2	

Note 4: V_{OS} is the voltage measurement defined as V_{OUT} subtracted from V_{REFEN} .



2A DDR TERMINATION REGULATOR

AP2302L

Typical Performance Characteristics

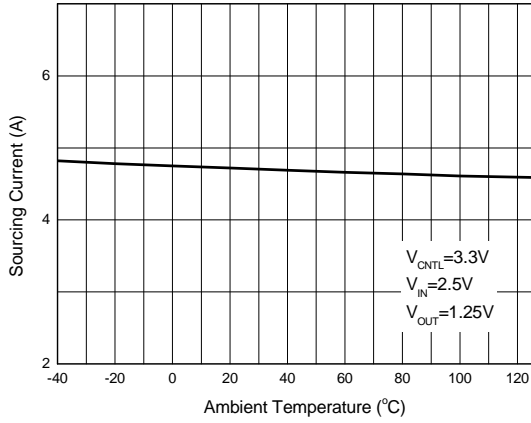

Figure 4. Sourcing Current vs. Ambient Temperature

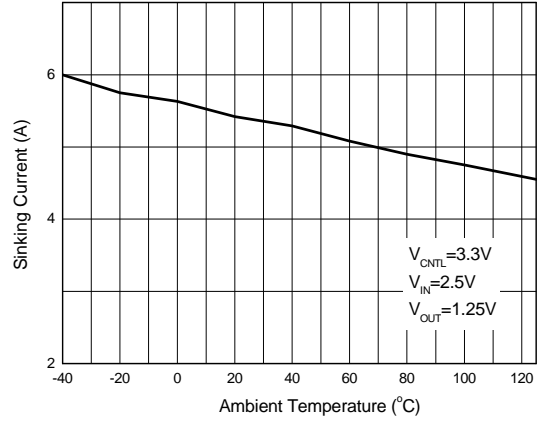

Figure 5. Sinking Current vs. Ambient Temperature

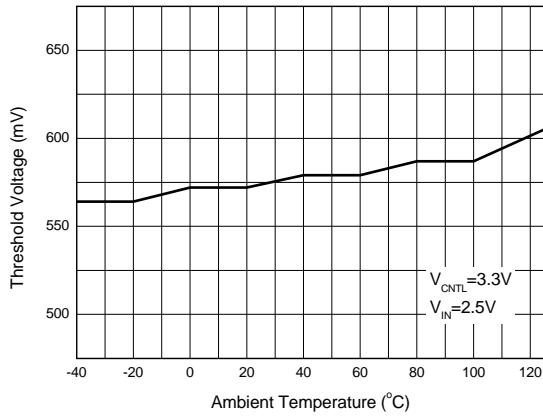

Figure 6. Threshold Voltage vs. Ambient Temperature

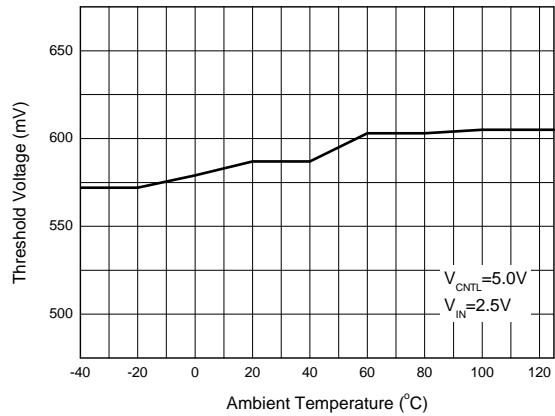

Figure 7. Threshold Voltage vs. Ambient Temperature



2A DDR TERMINATION REGULATOR

AP2302L

Typical Performance Characteristics (Continued)

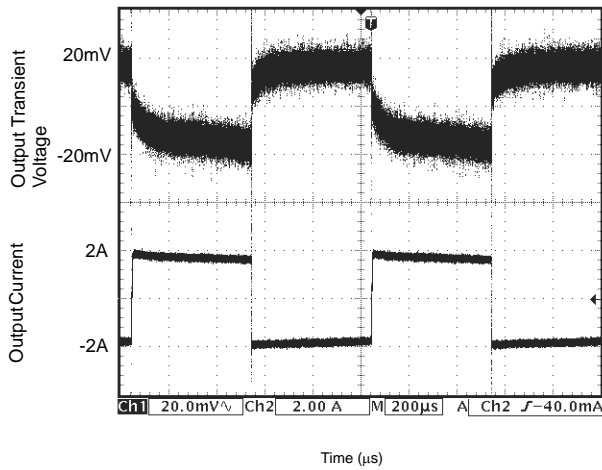

Figure 8. 0.9V_{TT} at 2A Transient Response

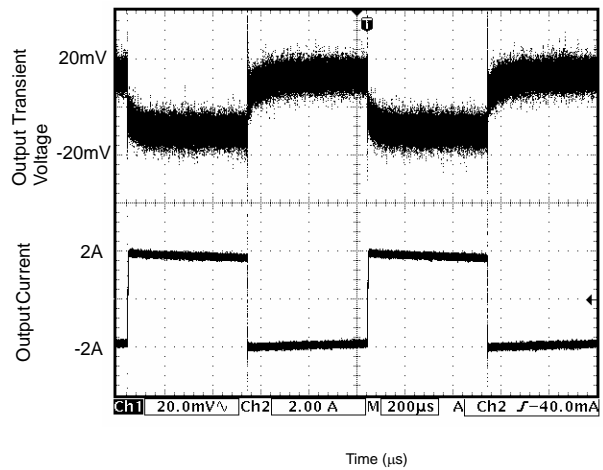

Figure 9. 1.25V_{TT} at 2A Transient Response

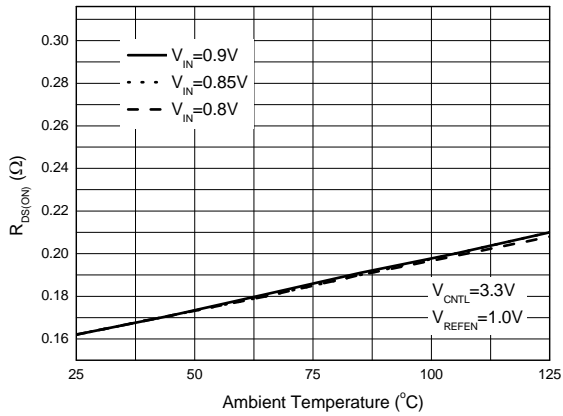

Figure 10. R_{DS(on)} vs. Ambient Temperature

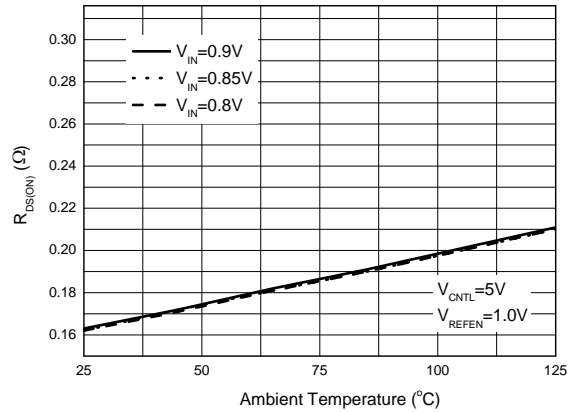

Figure 11. R_{DS(on)} vs. Ambient Temperature



2A DDR TERMINATION REGULATOR

AP2302L

Typical Performance Characteristics (Continued)

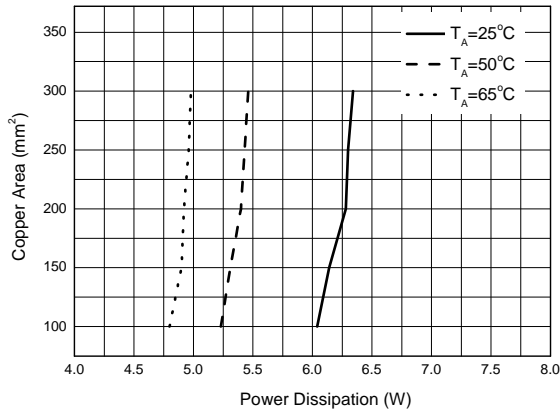

Figure 12. Copper Area vs. Power Dissipation (For SOIC-8)

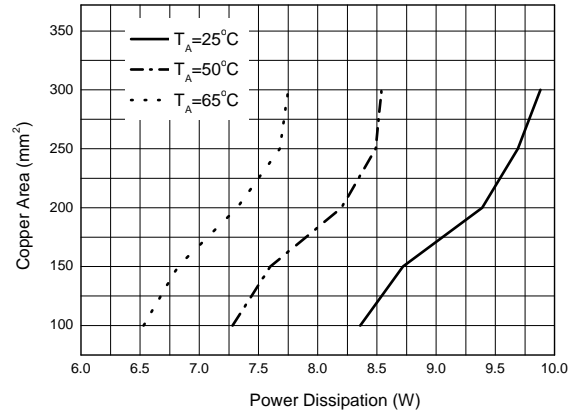

Figure 13. Copper Area vs. Power Dissipation (For TO-252-5)



2A DDR TERMINATION REGULATOR

AP2302L

Typical Application

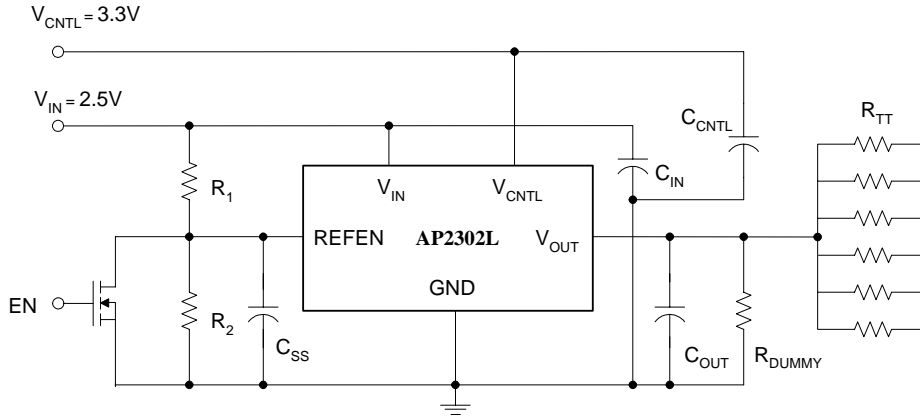

Figure 14. Typical Application of AP2302L

$R_1 = R_2 = 100K\Omega$, $R_{TT} = 50\Omega / 33\Omega / 25\Omega$

$R_{DUMMY} = 1K\Omega$, as for V_{OUT} discharge when V_{IN} is not present but V_{CNTL} is present

$C_{SS} = 1\mu F$, $C_{IN} = 470\mu F$, $C_{CNTL} = 47\mu F$, $C_{OUT} = 470\mu F$



2A DDR TERMINATION REGULATOR

AP2302L

Mechanical Dimensions

SOIC-8

Unit: mm(inch)

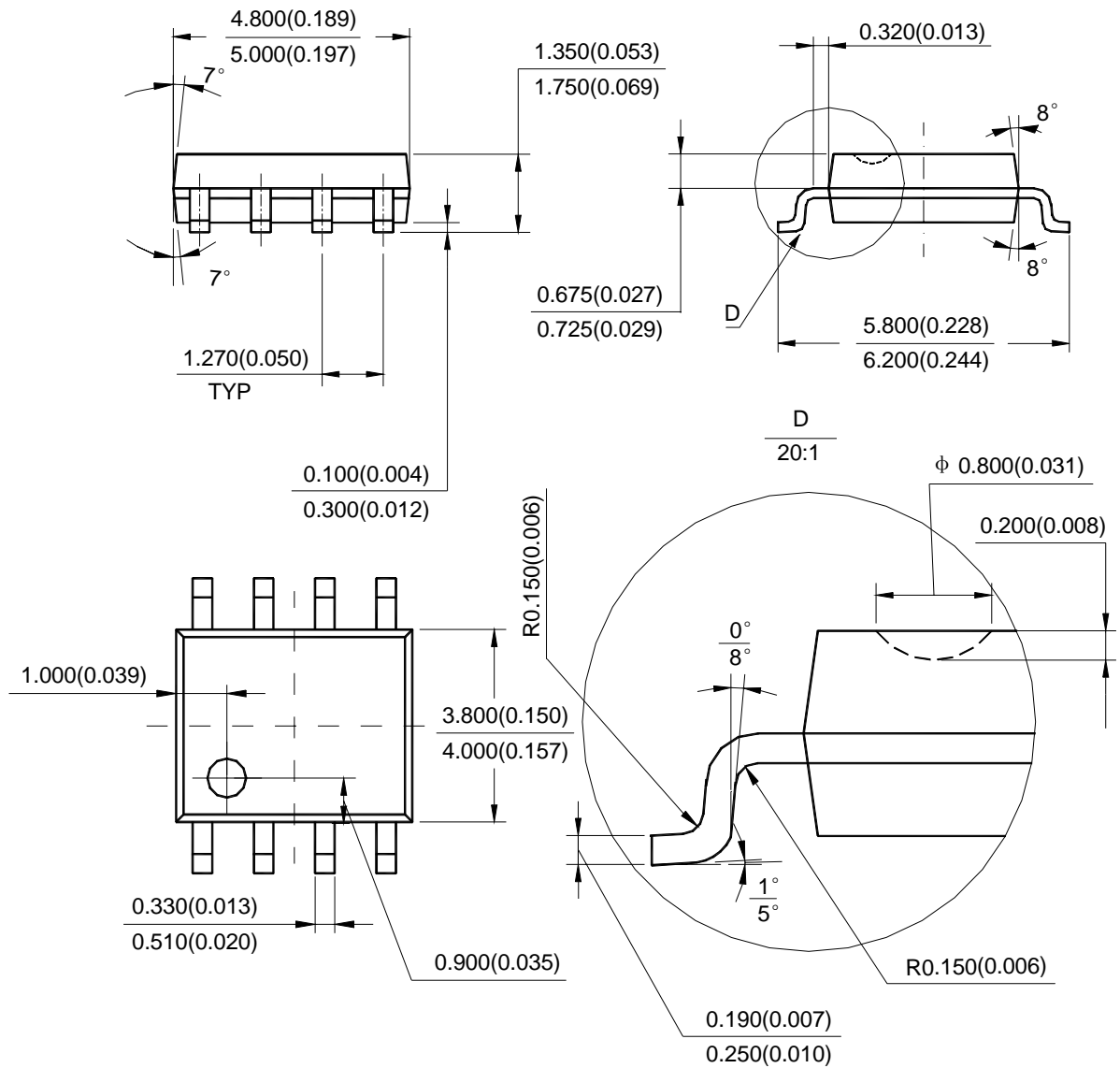



2A DDR TERMINATION REGULATOR

AP2302L

Mechanical Dimensions (Continued)

TO-252-5

Unit: mm(inch)

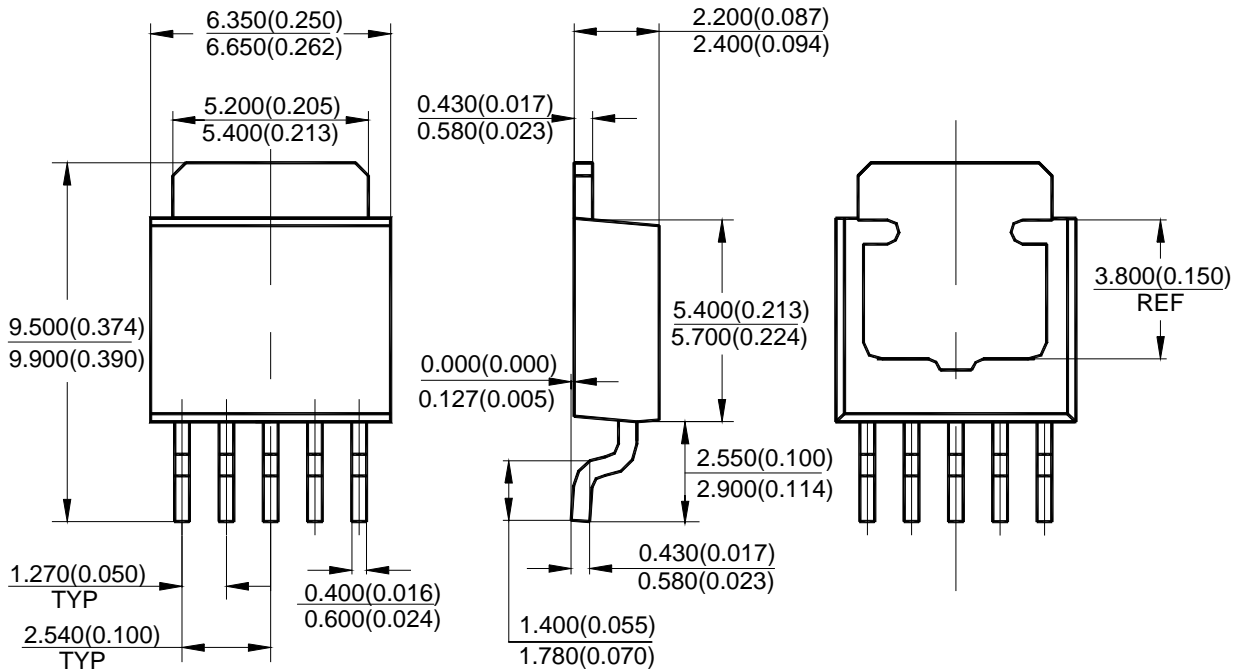



BCD Semiconductor Manufacturing Limited

<http://www.bcdsemi.com>

IMPORTANT NOTICE

BCD Semiconductor Manufacturing Limited reserves the right to make changes without further notice to any products or specifications herein. BCD Semiconductor Manufacturing Limited does not assume any responsibility for use of any its products for any particular purpose, nor does BCD Semiconductor Manufacturing Limited assume any liability arising out of the application or use of any its products or circuits. BCD Semiconductor Manufacturing Limited does not convey any license under its patent rights or other rights nor the rights of others.

MAIN SITE

BCD Semiconductor Manufacturing Limited
- Wafer Fab
Shanghai SIM-BCD Semiconductor Manufacturing Limited
800, Yi Shan Road, Shanghai 200233, China
Tel: +86-21-6485 1491, Fax: +86-21-5450 0008

BCD Semiconductor Manufacturing Limited
- IC Design Group
Advanced Analog Circuits (Shanghai) Corporation
8F, Zone B, 900, Yi Shan Road, Shanghai 200233, China
Tel: +86-21-6495 9539, Fax: +86-21-6485 9673

REGIONAL SALES OFFICE

Shenzhen Office
Shanghai SIM-BCD Semiconductor Manufacturing Co., Ltd. Shenzhen Office
Advanced Analog Circuits (Shanghai) Corporation Shenzhen Office
27B, Tower C, 2070, Middle Shen Nan Road, Shenzhen 518031, China
Tel: +86-755-8368 3987, Fax: +86-755-8368 3166

Taiwan Office
BCD Semiconductor (Taiwan) Company Limited
4F, 298-1, Rui Guang Road, Nei-Hu District, Taipei,
Taiwan
Tel: +886-2-2656 2808, Fax: +886-2-2656 2806

USA Office
BCD Semiconductor Corporation
3170 De La Cruz Blvd., Suite 105, Santa Clara,
CA 95054-2411, U.S.A
Tel: +1-408-988 6388, Fax: +1-408-988 6386