



AP622

UMTS-band 4W HBT Amplifier Module

Product Features

- 2.11 – 2.17 GHz
- 28 dB Gain
- -55 dBc ACLR @ +23 dBm Pavg
- +35 dBm P1dB
- +28 V Supply
- Power Down Mode
- RoHS-compliant flange-mount pkg

Applications

- WCDMA Power Amplifiers
- Repeaters

Product Description

The AP622 power amplifier module is a two-stage power amplifier module that operates over the frequency range of 2110 – 2170 MHz and is housed in a small, RoHS-compliant, flange-mount package. The multi-stage amplifier module has a 28 dB gain, P1dB of 35dBm, and ACLR of -55dBc at +23 dBm output power for WCDMA applications.

The AP622 uses a +28V high reliability InGaP/GaAs HBT process technology and does not require any external matching components. The amplifier module operates off a +28V supply; an internal active bias allows the amplifier to maintain high linearity over temperature. It has the added feature of a +5V power down control pin. A low-cost metal housing allows the device to have a low thermal resistance to ensure long lifetimes. All devices are 100% RF and DC tested.

The AP622 is targeted for use as a driver stage amplifier in wireless infrastructure where high linearity and high power is required. This combination makes the device an excellent candidate for next generation multi-carrier 3G base stations.

Functional Diagram

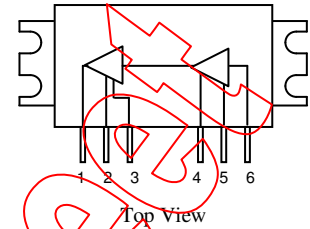

Pin No.	Function
1	RF Output
2/4	Vcc
3/5	Vpd
6	RF Input
Case	Ground

Specifications

W-CDMA 3GPP Test Model 1+64 DPCH, 60% clipping, PAR = 8.6 dB @ 0.01% Probability, 3.84 MHz BW, Vcc = +28V, Icq = 120 mA

Parameter	Units	Min	Typ	Max
Operational Bandwidth	MHz		2110 - 2170	
Output Channel Power	dBm		+23	
Power Gain	dB		28	
ACLR	dBc		-55	
Operating Current, Icc	mA		135	
Collector Efficiency	%		5	
Output P1dB	dBm		+35	
Quiescent Current, Icq	mA		120	
Vpd	V		+5	
Vcc	V		+28	

Absolute Maximum Rating

Parameter	Rating
Operating Case Temperature	-40 to +85 °C
Storage Temperature	-55 to +150 °C

Operation of this device above any of these parameters may cause permanent damage.

Ordering Information

Part No.	Description
AP622	PCS-band 4W HBT Amplifier Module

Specifications and information are subject to change without notice



AP622

UMTS-band 4W HBT Amplifier Module

Evaluation Board Bias Procedure

The following bias procedure is recommended to ensure proper functionality of AP622 in a laboratory environment. The sequencing is not required in the final system application.

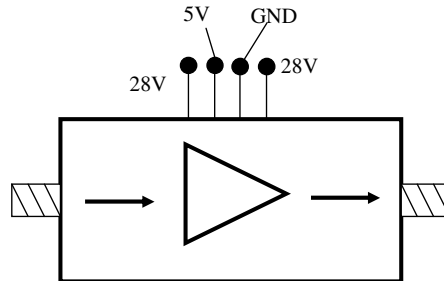

Turn-on Sequence:

1. Attach input and output loads onto the evaluation board.
2. Turn on power supply $V_{cc} = +28V$.
3. Turn on power supply $V_{pd} = +5V$.
4. Turn on RF power.

Turn-off Sequence:

1. Turn off RF power.
2. Turn off power supply $V_{pd} = +5V$.
3. Turn off power supply $V_{cc} = +28V$.

Notes:

1. V_{pd} is used as a reference for the internal active bias circuitry. It can be used to turn on/off the amplifier.

Preliminary Datasheet



AP622

UMTS-band 4W HBT Amplifier Module

Performance Graphs

W-CDMA 3GPP Test Model 1+64 DPCH, 60% clipping, PAR = 8.6 dB @ 0.01% Probability, 3.84 MHz BW, Vcc = +28V, Icq = 120 mA

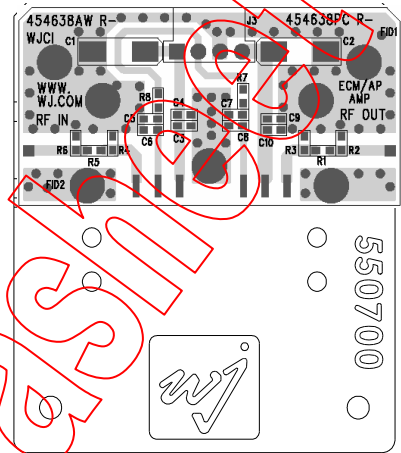
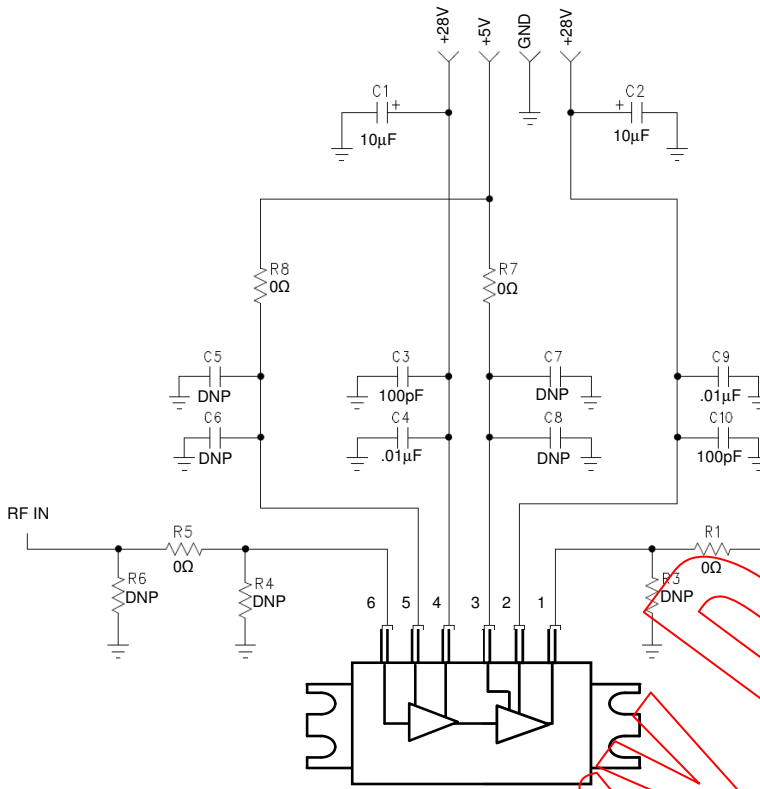

Notes:

- Please note that for reliable operation, the evaluation board will have to be mounted to a much larger heat sink during operation and in laboratory environments to dissipate the power consumed by the device. The use of a convection fan is also recommended in laboratory environments. Details of the mounting holes used in the WJ heatsink are given on the last page of this datasheet.
- The area around the module underneath the PCB should not contain any soldermask in order to maintain good RF grounding.
- For proper and safe operation in the laboratory, the power-on sequencing should be followed:
 - Connect RF In and Out
 - Connect the voltages and ground pins as shown in the circuit.
 - Apply the RF signal
 - Power down with the reverse sequence

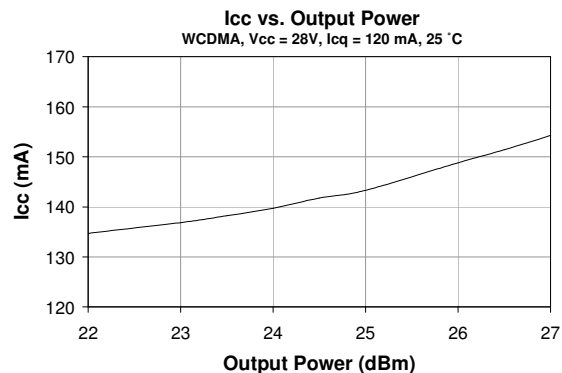
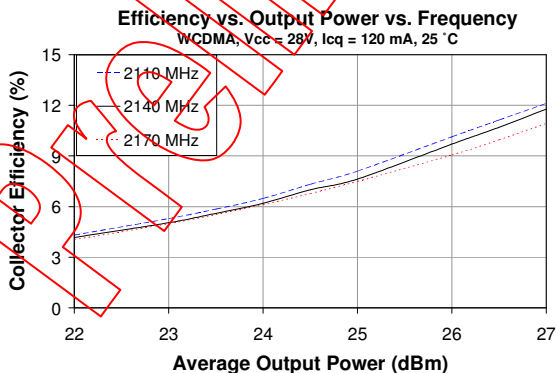
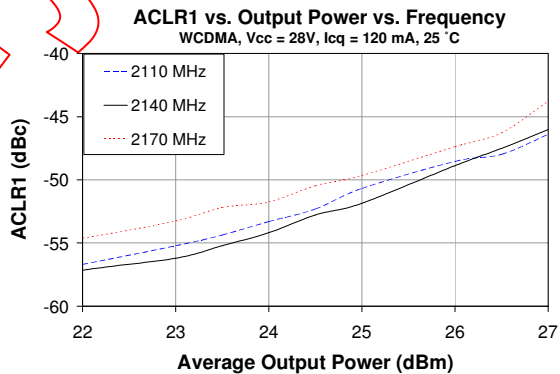
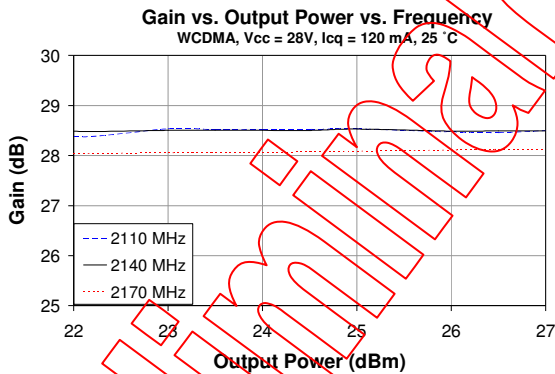

Specifications and information are subject to change without notice



AP622

UMTS-band 4W HBT Amplifier Module

Outline Drawing

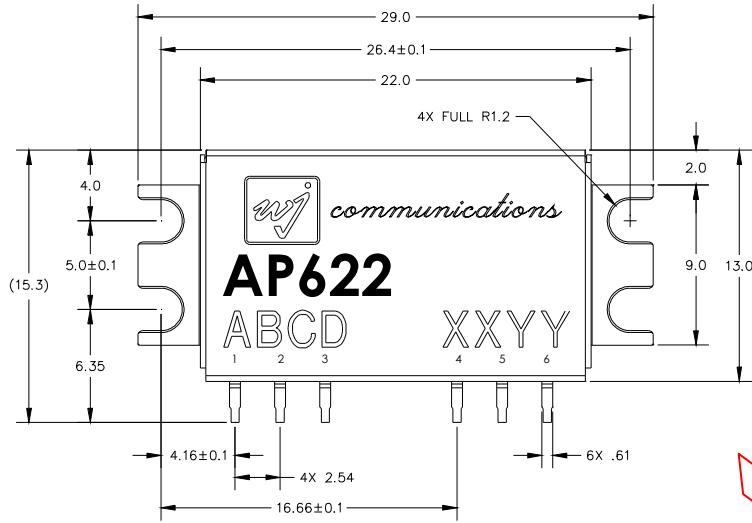

NOTES:

1. DIMENSIONING & TOLERANCING CONFORM TO ANSI Y14.4M-1994.
2. ALL DIMENSIONS ARE IN MILLIMETERS (INCHES). ANGLES ARE IN DEGREES.
3. PIN ASSIGNMENTS:
 [PIN 1] RF OUT
 [PIN 2] +28 Vcc
 [PIN 3] +5 Vpd
 [PIN 4] +28 Vcc
 [PIN 5] +5 Vpd
 [PIN 6] RF IN
 [CASE] GROUND

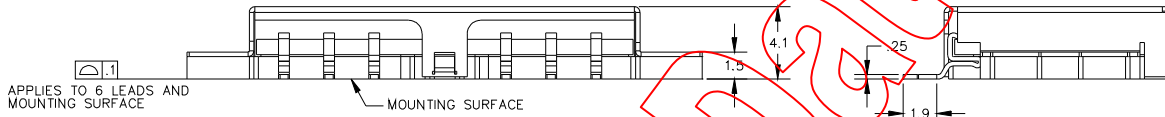

Outline Drawing for the Heatsink with the WJ Evaluation Board

