

Features

- 20V/-2.8A
- $R_{DS(ON)} = 56m\Omega$ (typ.) @ $V_{GS} = -4.5V$
- $R_{DS(ON)} = 85m\Omega$ (typ.) @ $V_{GS} = -2.5V$
- $R_{DS(ON)} = 106m\Omega$ (typ.) @ $V_{GS} = -1.8V$
- Super High Dense Cell Design
- Reliable and Rugged

Pin Description

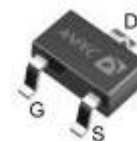

SOT-23

Applications

- Power Management in Notebook Computer, Portable Equipment and Battery Powered Systems.

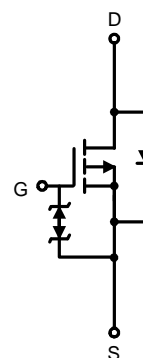

P Channel MOSFET

Ordering and Marking Information

<p>APM2301CA □□-□□□</p> <p> □□□ Lead Free Code □□□ Handling Code □□□ Temp. Range □□□ Package Code </p>	<p>Package Code A : SOT-23</p> <p>Operating Junction Temp. Range C : -55 to 150 °C</p> <p>Handling Code TR : Tape & Reel</p> <p>Lead Free Code L : Lead Free Device Blank : Original Device</p>
<p>APM2301CA: C01X</p>	<p>XXXXX - Date Code</p>

Note: ANPEC lead-free products contain molding compounds/die attach materials and 100% matte tin plate termination finish; which are fully compliant with RoHS and compatible with both SnPb and lead-free soldering operations. ANPEC lead-free products meet or exceed the lead-free requirements of IPC/JEDEC J STD-020C for MSL classification at lead-free peak reflow temperature.

ANPEC reserves the right to make changes to improve reliability or manufacturability without notice, and advise customers to obtain the latest version of relevant information to verify before placing orders.

Absolute Maximum Ratings ($T_A = 25^\circ\text{C}$ Unless Otherwise Noted)

Symbol	Parameter	Rating	Unit	
V_{DSS}	Drain-Source Voltage	-20	V	
V_{GSS}	Gate-Source Voltage	± 12		
I_D^*	Continuous Drain Current	-2.8	A	
I_{DM}^*	300 μs Pulsed Drain Current			-12
I_S^*	Diode Continuous Forward Current	-1.3	A	
T_J	Maximum Junction Temperature	150	$^\circ\text{C}$	
T_{STG}	Storage Temperature Range	-55 to 150		
P_D^*	Maximum Power Dissipation	$T_A = 25^\circ\text{C}$	0.83	W
		$T_A = 100^\circ\text{C}$	0.3	
$R_{\theta JA}^*$	Thermal Resistance-Junction to Ambient	150	$^\circ\text{C/W}$	

Notes: *Surface Mounted on 1in² pad area, $t \leq 10\text{sec}$.

Electrical Characteristics ($T_A = 25^\circ\text{C}$ Unless Otherwise Noted)

Symbol	Parameter	Test Condition	APM2301CA			Unit
			Min.	Typ.	Max.	
Static Characteristics						
BV_{DSS}	Drain-Source Breakdown Voltage	$V_{GS}=0V, I_{DS}=250\mu A$	-20			V
I_{DSS}	Zero Gate Voltage Drain Current	$V_{DS}=-16V, V_{GS}=0V$ $T_J=85^\circ\text{C}$			-1	μA
					-30	
$V_{GS(th)}$	Gate Threshold Voltage	$V_{DS}=V_{GS}, I_{DS}=-250\mu A$	-0.5	-0.75	-1	V
I_{GSS}	Gate Leakage Current	$V_{GS}=\pm 12V, V_{DS}=0V$			± 10	μA
$R_{DS(ON)}^a$	Drain-Source On-State Resistance	$V_{GS}=-4.5V, I_{DS}=-2.8A$		56	70	m Ω
		$V_{GS}=-2.5V, I_{DS}=-2A$		85	115	
		$V_{GS}=-1.8V, I_{DS}=-1A$		106	165	
V_{SD}^a	Diode Forward Voltage	$I_{SD}=-1.3A, V_{GS}=0V$		-0.75	-1.3	V
Gate Charge Characteristics^b						
Q_g	Total Gate Charge	$V_{DS}=-10V, V_{GS}=-4.5V,$ $I_{DS}=-2.8A$		7	10	nC
Q_{gs}	Gate-Source Charge			1.9		
Q_{gd}	Gate-Drain Charge			1.9		

Electrical Characteristics (Cont.) (T_A = 25°C Unless Otherwise Noted)

Symbol	Parameter	Test Condition	APM2301CA			Unit
			Min.	Typ.	Max.	
Dynamic Characteristics^b						
C _{iss}	Input Capacitance	V _{GS} =0V, V _{DS} =-10V, Frequency=1.0MHz		580		pF
C _{oss}	Output Capacitance			100		
C _{rss}	Reverse Transfer Capacitance			75		
t _{d(ON)}	Turn-on Delay Time	V _{DD} =-10V, R _L =10Ω, I _{DS} =1A, V _{GEN} =-4.5V, R _G =6Ω		4	7	ns
t _r	Turn-on Rise Time			13	23	
t _{d(OFF)}	Turn-off Delay Time			35	63	
t _f	Turn-off Fall Time			20	36	
t _{rr}	Reverse Recovery Time	I _{SD} =-2.8A, dI _{SD} /dt =100A/μs		20		ns
Q _{rr}	Reverse Recovery Charge			7		nC

Notes:

- a : Pulse test ; pulse width≤300μs, duty cycle≤2%.
- b : Guaranteed by design, not subject to production testing.

Typical Characteristics

Power Dissipation

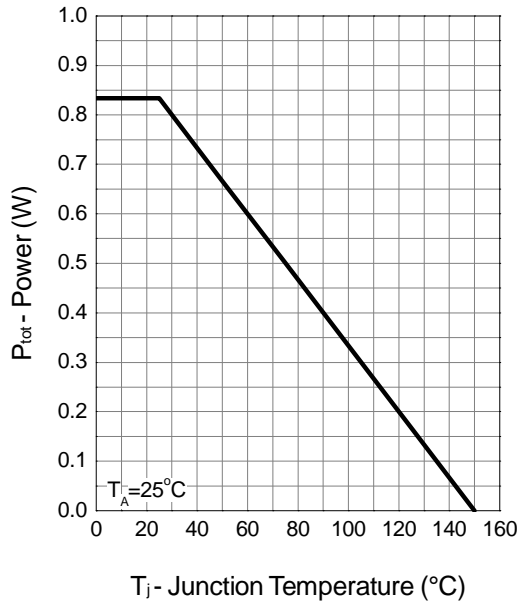

Drain Current

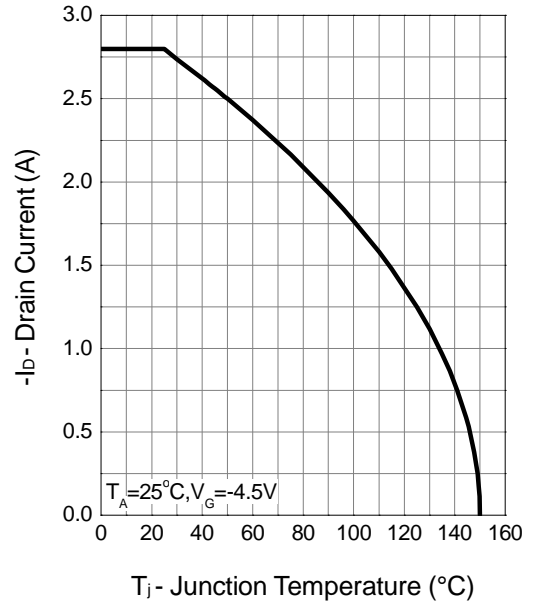

Safe Operation Area

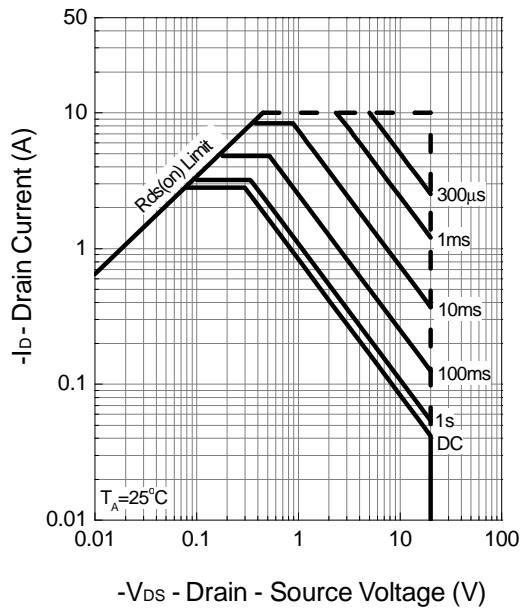

Thermal Transient Impedance

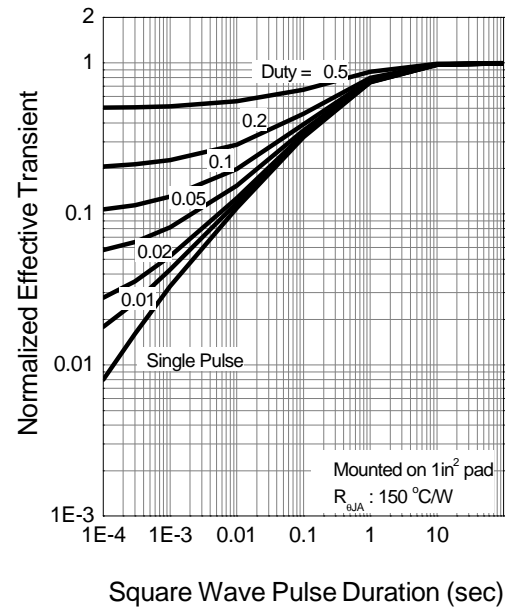

Typical Characteristics (Cont.)

Output Characteristics

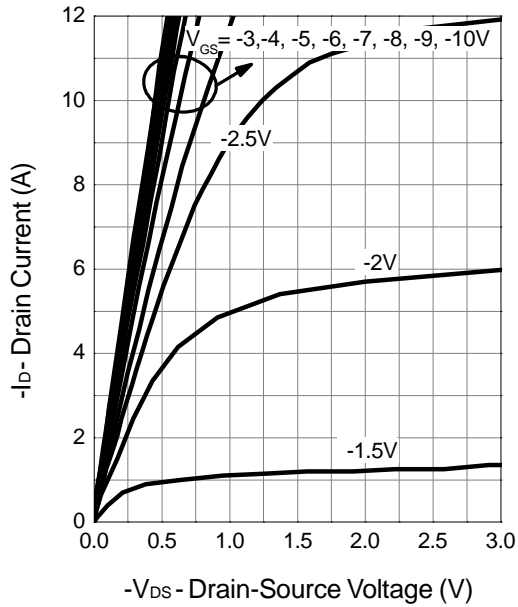

Drain-Source On Resistance

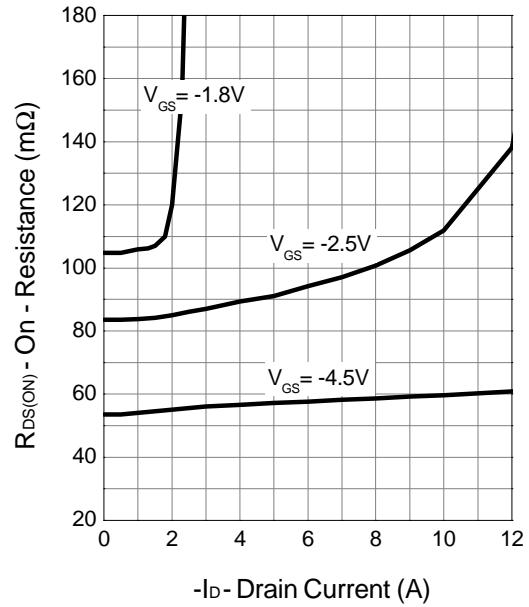

Drain-Source On Resistance

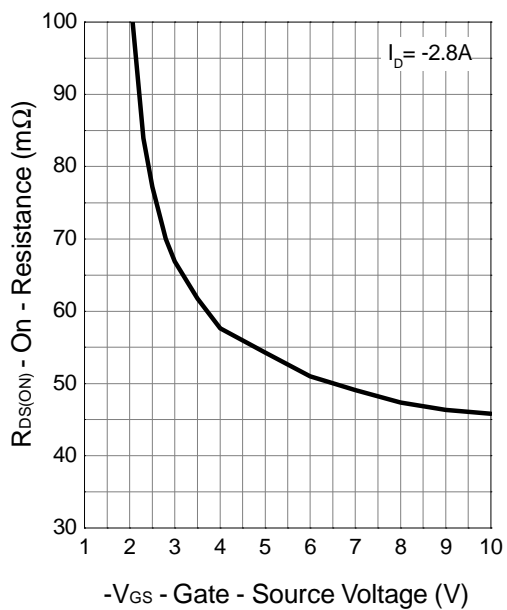

Gate Threshold Voltage

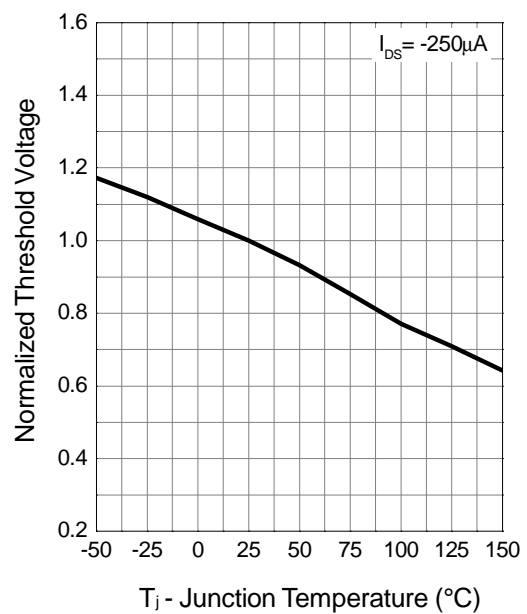

Typical Characteristics (Cont.)

Drain-Source On Resistance

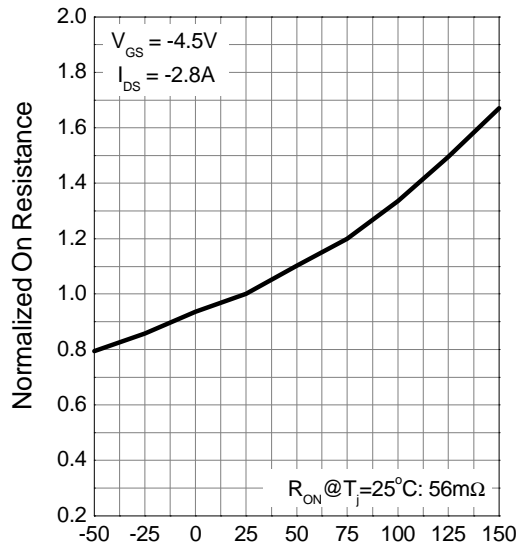

T_j - Junction Temperature ($^\circ C$)

Source-Drain Diode Forward

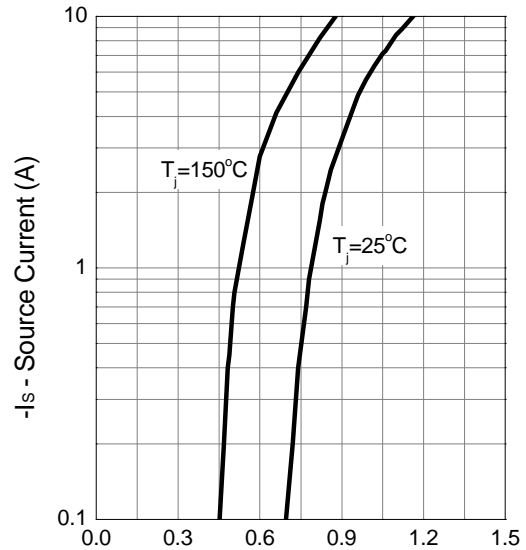

$-V_{SD}$ - Source - Drain Voltage (V)

Capacitance

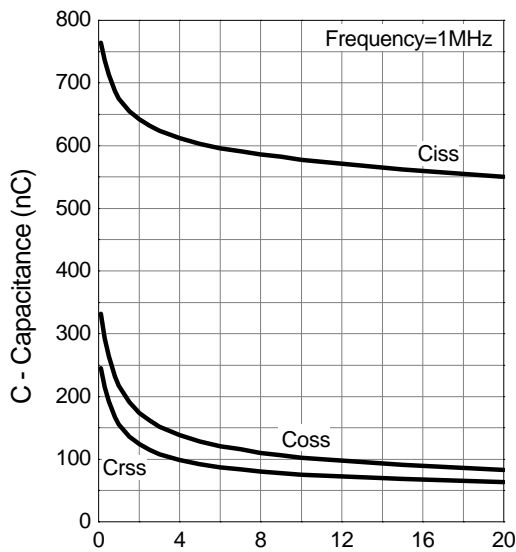

$-V_{DS}$ - Drain - Source Voltage (V)

Gate Charge

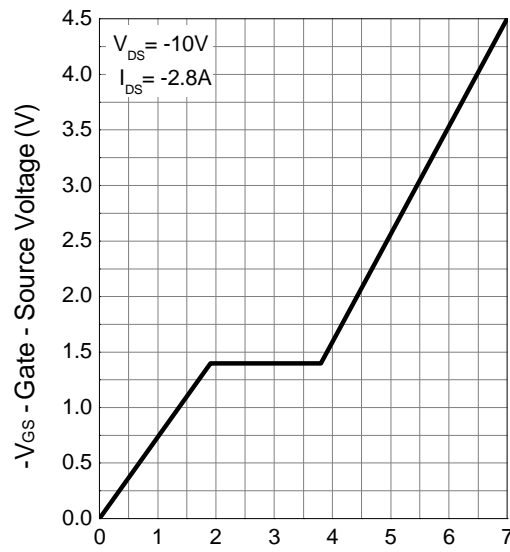

Q_G - Gate Charge (nC)

Packaging Information

SOT-23

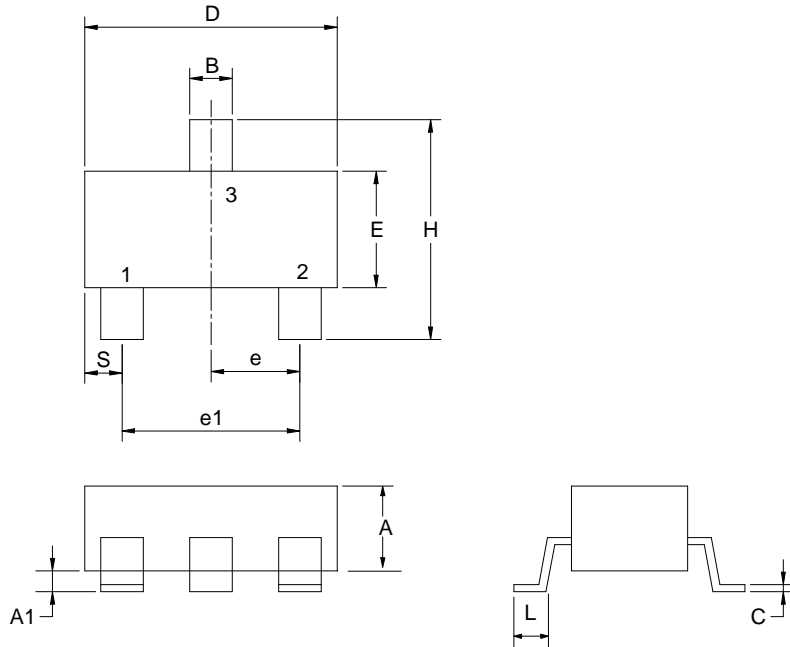

Dim	Parameter		Inches	
	Min.	Max.	Min.	Max.
A	1.00	1.30	0.039	0.051
A1	0.00	0.10	0.000	0.004
B	0.35	0.51	0.014	0.020
C	0.10	0.25	0.004	0.010
D	2.70	3.10	0.106	0.122
E	1.40	1.80	0.055	0.071
e1	1.90 TYP		0.075 TYP	
H	2.40	3.00	0.094	0.118
L	0.37		0.015	

Physical Specifications

Terminal Material	Solder-Plated Copper (Solder Material : 90/10 or 63/37 SnPb,100%Sn).
Lead Solderability	Meets EIA Specification RSI86-91, ANSI/J-STD-002 Category 3.

Reflow Condition

(IR/Convection or VPR Reflow)

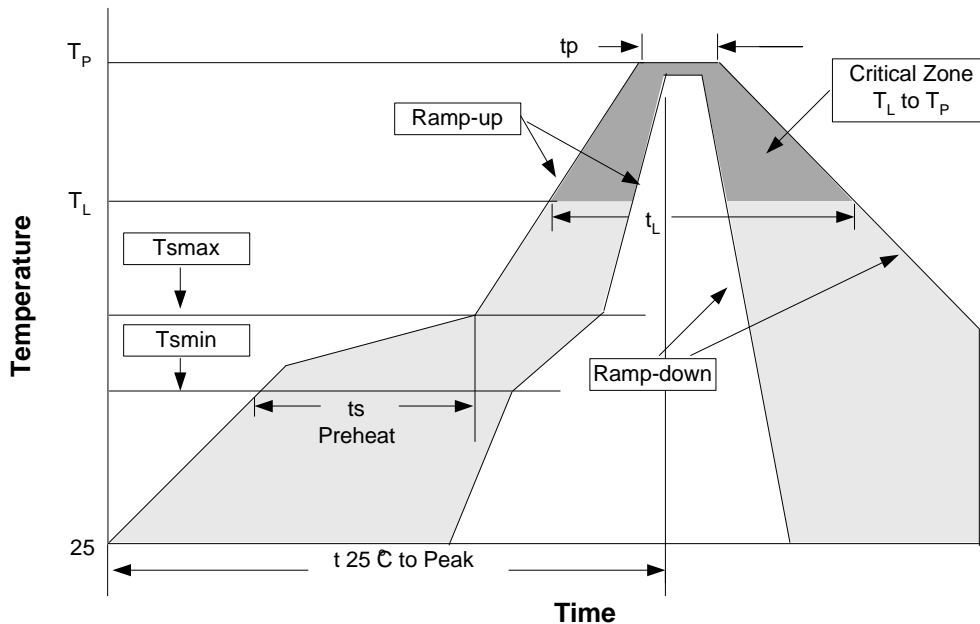

Reflow Condition

Profile Feature	Sn-Pb Eutectic Assembly		Pb-Free Assembly	
	Large Body	Small Body	Large Body	Small Body
Average ramp-up rate(T_L to T_P)	3°C/second max.		3°C/second max.	
Preheat				
-Temperature Min (T_{smin})	100°C		150°C	
-Temperature Max (T_{smax})	150°C		200°C	
-Time (min to max) (t_s)	60-120 seconds		60-180 seconds	
T_{smax} to T_L				
-Ramp-up Rate			3°C/second max	
Time maintained above:				
-Temperature (T_L)	183°C		217°C	
-Time (t_L)	60-150 seconds		60-150 seconds	
Peak Temperature (T_p)	225 +0/-5°C	240 +0/-5°C	245 +0/-5°C	250 +0/-5°C
Time within 5°C of actual Peak Temperature (t_p)	10-30 seconds	10-30 seconds	10-30 seconds	20-40 seconds
Ramp-down Rate	6°C/second max.		6°C/second max.	
Time 25°C to Peak Temperature	6 minutes max.		8 minutes max.	

Notes: All temperatures refer to topside of the package .Measured on the body surface.

Reflow Condition

pkg. thickness \approx 2.5mm and all bags	pkg. thickness < 2.5mm and pkg. volume \approx 350mm ³	pkg. thickness < 2.5mm and pkg. volume < 350mm ³
Convection 220 +5/-0°C		Convection 235 +5/-0°C
VPR 215-219°C		VPR 235 +5/-0°C
IR/Convection 220 +5/-0°C		IR/Convection 220 +5/-0°C

Reliability test program

Test Item	Method	Description
SOLDERABILITY	MIL-STD-883D-2003	245°C, 5 SEC
HOLT	MIL-STD 883D-1005.7	1000 Hrs Bias @125°C
PCT	JESD-22-B, A102	168 Hrs, 100% RH, 121°C
TST	MIL-STD 883D-1011.9	-65°C ~ 150°C, 200 Cycles

Carrier Tape & Reel Dimensions

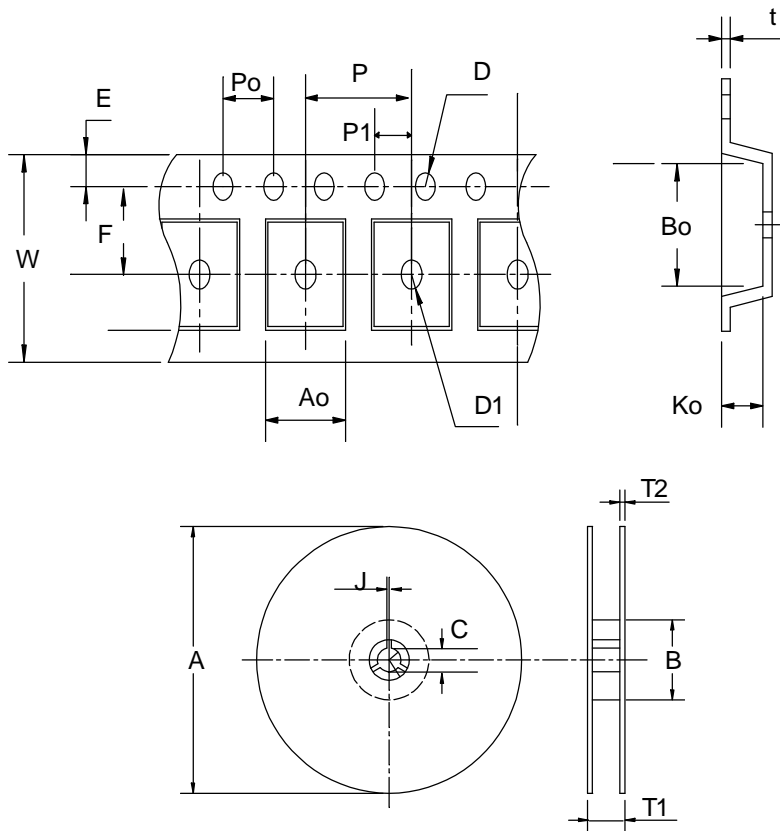

Carrier Tape & Reel Dimensions (Cont.)

Application	A	B	C	J	T1	T2	W	P	E
SOT-23	178±1	60±1.0	12.0	2.5±0.15	9.0±0.5	1.4	8.0±0.3	4.0	1.75
	F	D	D1	Po	P1	Ao	Bo	Ko	t
	3.5±0.05	1.5±0.1	φ0.1MIN	4.0	2.0±0.05	3.1	3.0	1.3	0.2±0.03

Cover Tape Dimensions

Application	Carrier Width	Cover Tape Width	Devices Per Reel
SOT-23	8	5.3	3000

Customer Service

Anpec Electronics Corp.

Head Office :

No.6, Dusing 1st Road, SBIP,

Hsin-Chu, Taiwan, R.O.C.

Tel : 886-3-5642000

Fax : 886-3-5642050

Taipei Branch :

7F, No. 137, Lane 235, Pac Chiao Rd.,

Hsin Tien City, Taipei Hsien, Taiwan, R. O. C.

Tel : 886-2-89191368

Fax : 886-2-89191369