

Dual P-Channel Enhancement Mode MOSFET

Features

- 20V/-3.5A , $R_{DS(ON)}=45m\Omega(\text{typ.}) @ V_{GS}=-4.5V$
 -2.9A , $R_{DS(ON)}=52m\Omega(\text{typ.}) @ V_{GS}=-3.0V$
 -2.6A , $R_{DS(ON)}=60m\Omega(\text{typ.}) @ V_{GS}=-2.7V$
- Super High Dense Cell Design for Extremely Low $R_{DS(ON)}$
- Reliable and Rugged
- SOP-8 Package

Applications

- Power Management in Notebook Computer , Portable Equipment and Battery Powered Systems.

Pin Description

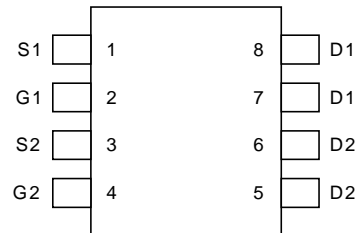

SOP – 8

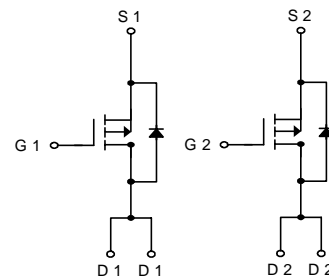

P-Channel MOSFET

Ordering and Marking Information

<p>APM9933 □□-□□</p> <p>Handling Code</p> <p>Temp. Range</p> <p>Package Code</p>	<p>Package Code K : SOP-8</p> <p>Operating Junction Temp. Range C : -55 to 150°C</p> <p>Handling Code TU : Tube TR : Tape & Reel</p>		
<p>APM9933 K :</p>	<table border="1" data-bbox="446 1354 576 1402"> <tr> <td>APM9933</td> <td>XXXXX</td> </tr> </table> <p>XXXXX - Date Code</p>	APM9933	XXXXX
APM9933	XXXXX		

Absolute Maximum Ratings $(T_A = 25^\circ\text{C}$ unless otherwise noted)

Symbol	Parameter	Rating	Unit
V_{DSS}	Drain-Source Voltage	-20	V
V_{GSS}	Gate-Source Voltage	± 12	
I_D^*	Maximum Drain Current – Continuous	-3.5	A
I_{DM}	Maximum Drain Current – Pulsed	-16	

* Surface Mounted on FR4 Board, $t \leq 10$ sec.

ANPEC reserves the right to make changes to improve reliability or manufacturability without notice, and advise customers to obtain the latest version of relevant information to verify before placing orders.

Absolute Maximum Ratings (Cont.) ($T_A = 25^\circ\text{C}$ unless otherwise noted)

Symbol	Parameter	Rating	Unit
P_D	Maximum Power Dissipation	$T_A=25^\circ\text{C}$	2.5
		$T_A=100^\circ\text{C}$	1.0
T_J	Maximum Junction Temperature	150	$^\circ\text{C}$
T_{STG}	Storage Temperature Range	-55 to 150	$^\circ\text{C}$
$R_{\theta JA}$	Thermal Resistance – Junction to Ambient	50	$^\circ\text{C/W}$

Electrical Characteristics ($T_A = 25^\circ\text{C}$ unless otherwise noted)

Symbol	Parameter	Test Condition	APM9933			Unit
			Min.	Typ.	Max.	
Static						
BV_{DSS}	Drain-Source Breakdown Voltage	$V_{GS}=0V, I_{DS}=-250\mu\text{A}$	-20			V
$\frac{\Delta BV_{DSS}}{\Delta T_j}$	Breakdown Voltage Temperature Coefficient	$I_D=-250\mu\text{A}$, Referenced to 25°C		-16		$\text{mV}/^\circ\text{C}$
I_{DSS}	Zero Gate Voltage Drain Current	$V_{DS}=-16V, V_{GS}=0V$			-1	μA
$V_{GS(th)}$	Gate Threshold Voltage	$V_{DS}=V_{GS}, I_{DS}=-250\mu\text{A}$	-0.5	-0.7	-1	V
I_{GSS}	Gate Leakage Current	$V_{GS}=\pm 12V, V_{DS}=0V$			± 100	nA
$\frac{\Delta V_{GS(th)}}{\Delta T_j}$	Gate Threshold Voltage Temperature Coefficient	$I_D=-250\mu\text{A}$, Referenced to 25°C		2.5		$\text{mV}/^\circ\text{C}$
$R_{DS(ON)}^a$	Drain-Source On-state Resistance	$V_{GS}=-4.5V, I_{DS}=-3.4A$		45	70	$\text{m}\Omega$
		$V_{GS}=-3.0V, I_{DS}=-2.9A$		52	80	
		$V_{GS}=-2.7V, I_{DS}=-2.6A$		60	100	
$I_{D(on)}$	On-State Drain Current	$V_{GS}=-4.5V, V_{DS}=-5.0V$	-10			A
g_{FS}	Forward Transconductance	$V_{DS}=-4.5V, I_D=-3.8A$		10		S
V_{SD}^a	Diode Forward Voltage	$I_{SD}=-2.0A, V_{GS}=0V$		-0.7	-1.3	V
Dynamic^b						
Q_g	Total Gate Charge	$V_{DS}=-6V, I_{DS}=-3.5A$		12.7	15	nC
Q_{gs}	Gate-Source Charge	$V_{GS}=-4.5V$		1.75		
Q_{gd}	Gate-Drain Charge			2.8		
$t_{d(ON)}$	Turn-on Delay Time	$V_{DD}=-6V, I_{DS}=-1A,$		12	21	ns
T_r	Turn-on Rise Time	$V_{GEN}=-4.5V, R_G=6\Omega,$		25	42	
$t_{d(OFF)}$	Turn-off Delay Time	$R_L=6\Omega$		52	85	
T_f	Turn-off Fall Time			18	32	
C_{iss}	Input Capacitance	$V_{GS}=0V$		1290		pF
C_{oss}	Output Capacitance	$V_{DS}=-15V$		300		
C_{rss}	Reverse Transfer Capacitance	Frequency=1.0MHz		210		

Notes

^a : Pulse test ; pulse width $\leq 300\mu\text{s}$, duty cycle $\leq 2\%$

^b : Guaranteed by design, not subject to production testing

Typical Characteristics

Output Characteristics

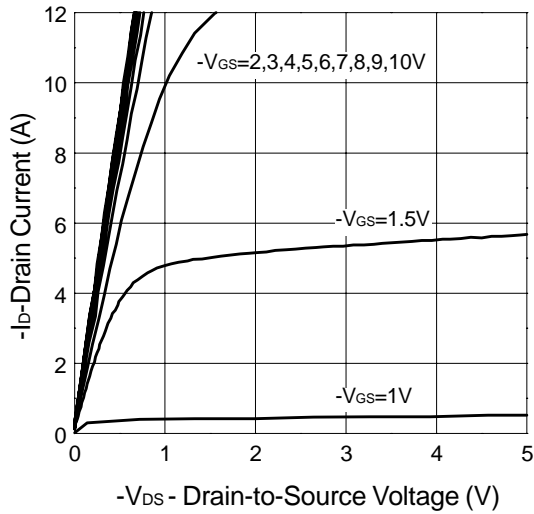

Transfer Characteristics

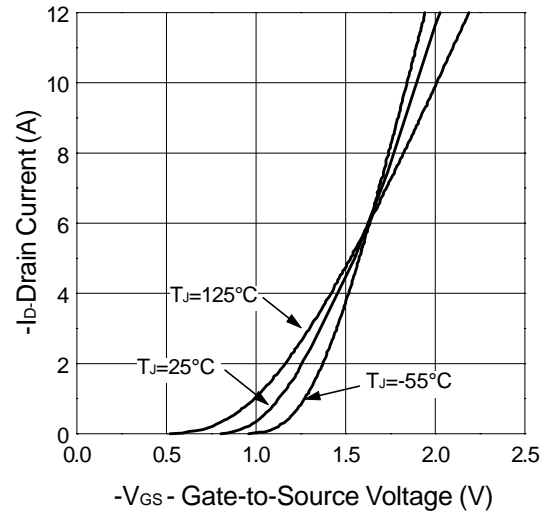

Threshold Voltage vs. Junction Temperature

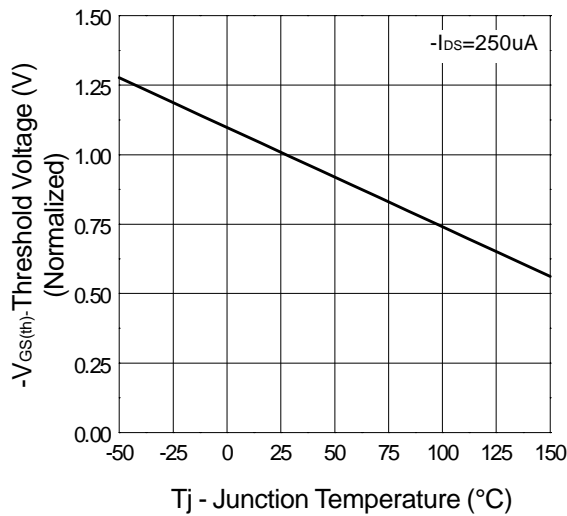

On-Resistance vs. Drain Current

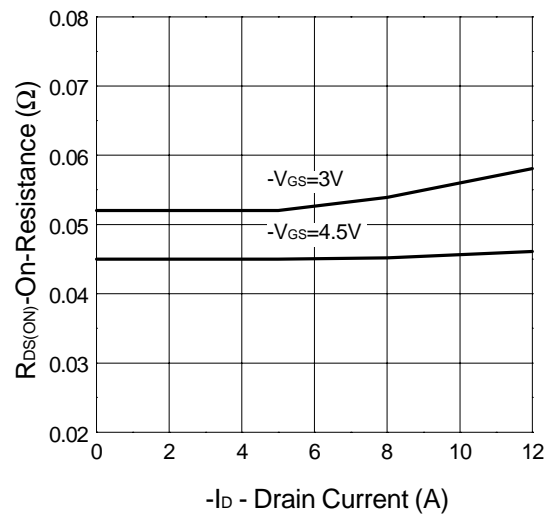

Typical Characteristics (Cont.)

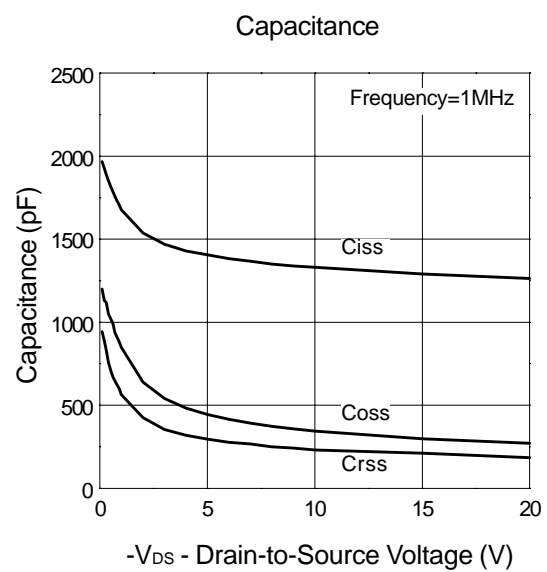
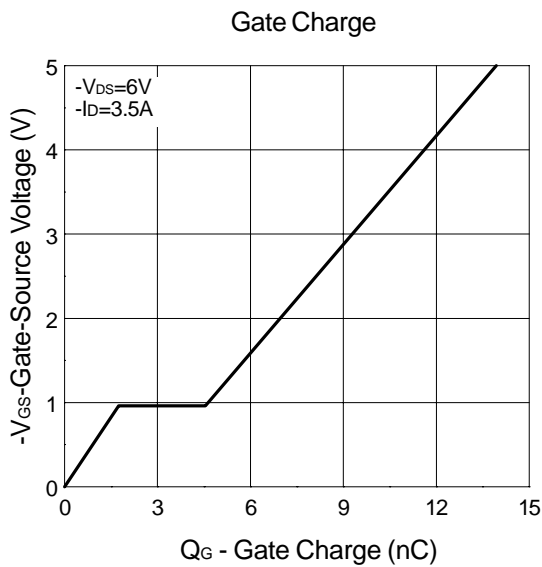
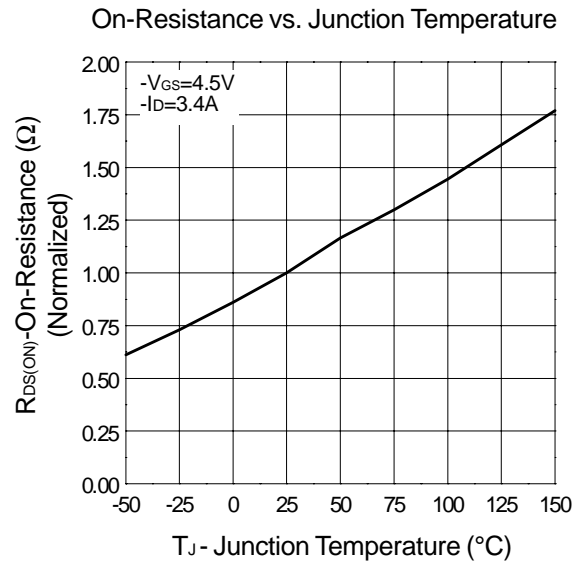
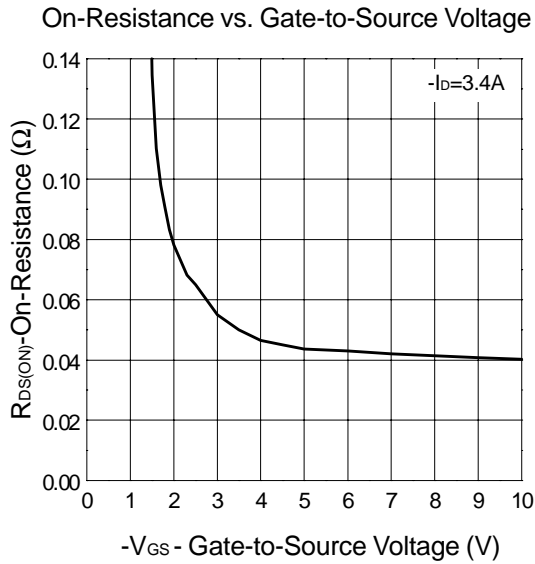

Typical Characteristics (Cont.)

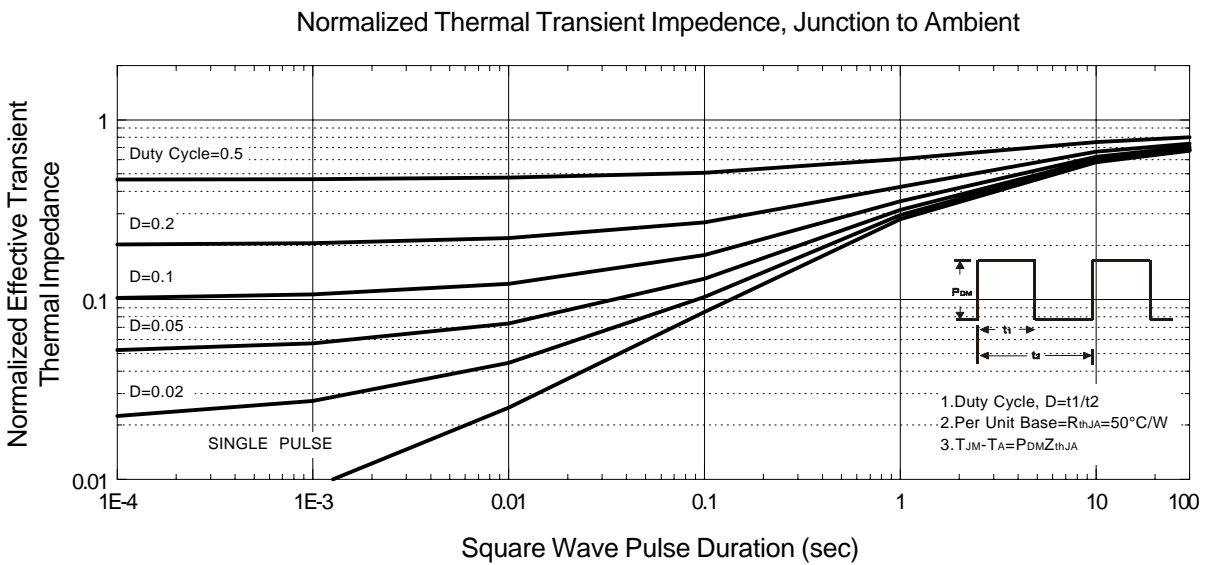
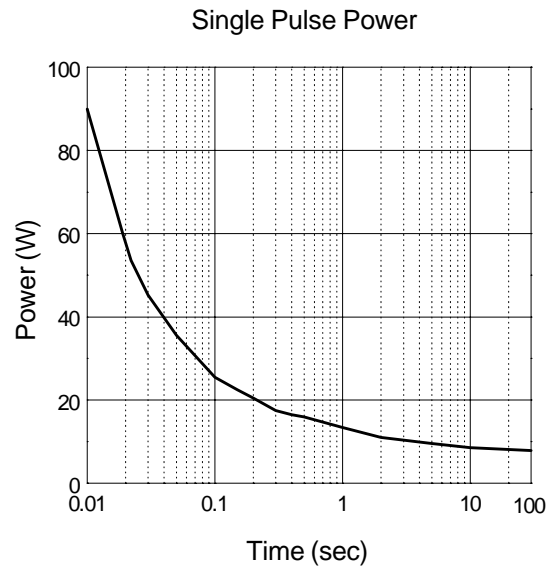
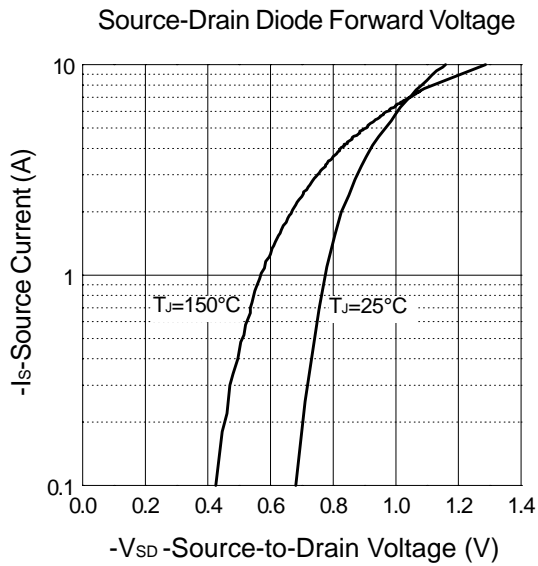

Packaging Information

SOP-8 pin (Reference JEDEC Registration MS-012)

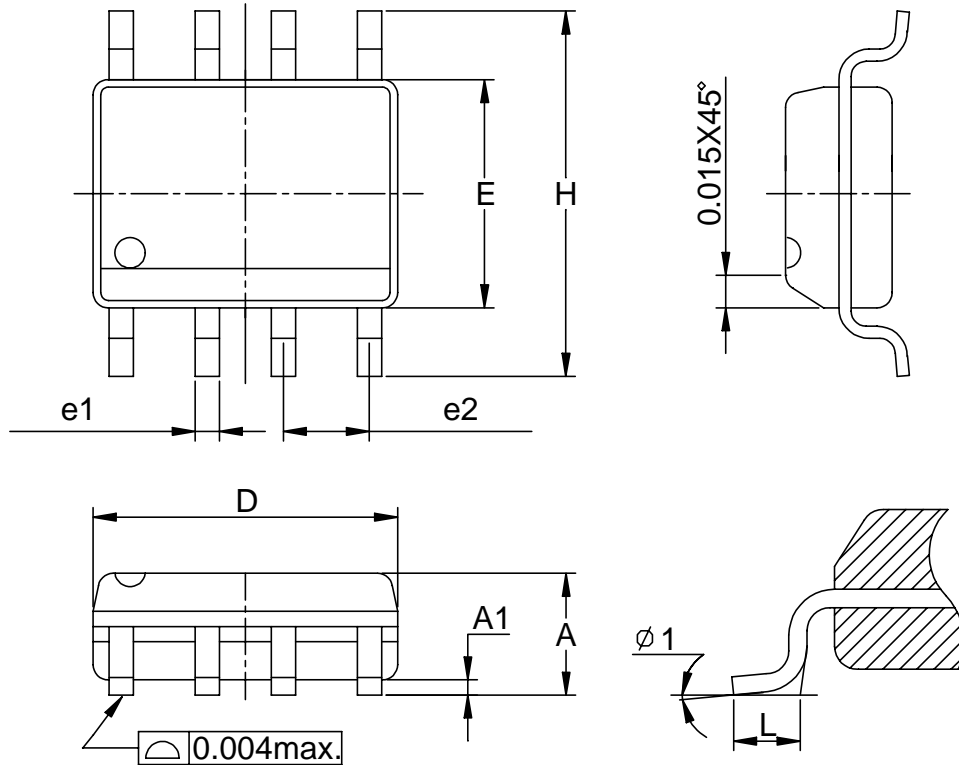

Dim	Millimeters		Inches	
	Min.	Max.	Min.	Max.
A	1.35	1.75	0.053	0.069
A1	0.10	0.25	0.004	0.010
D	4.80	5.00	0.189	0.197
E	3.80	4.00	0.150	0.157
H	5.80	6.20	0.228	0.244
L	0.40	1.27	0.016	0.050
e1	0.33	0.51	0.013	0.020
e2	1.27BSC		0.50BSC	
φ 1	8°		8°	

Physical Specifications

Terminal Material	Solder-Plated Copper (Solder Material : 90/10 or 63/37 SnPb)
Lead Solderability	Meets EIA Specification RSI86-91, ANSI/J-STD-002 Category 3.

Reflow Condition (IR/Convection or VPR Reflow)

Reference JEDEC Standard J-STD-020A APRIL 1999

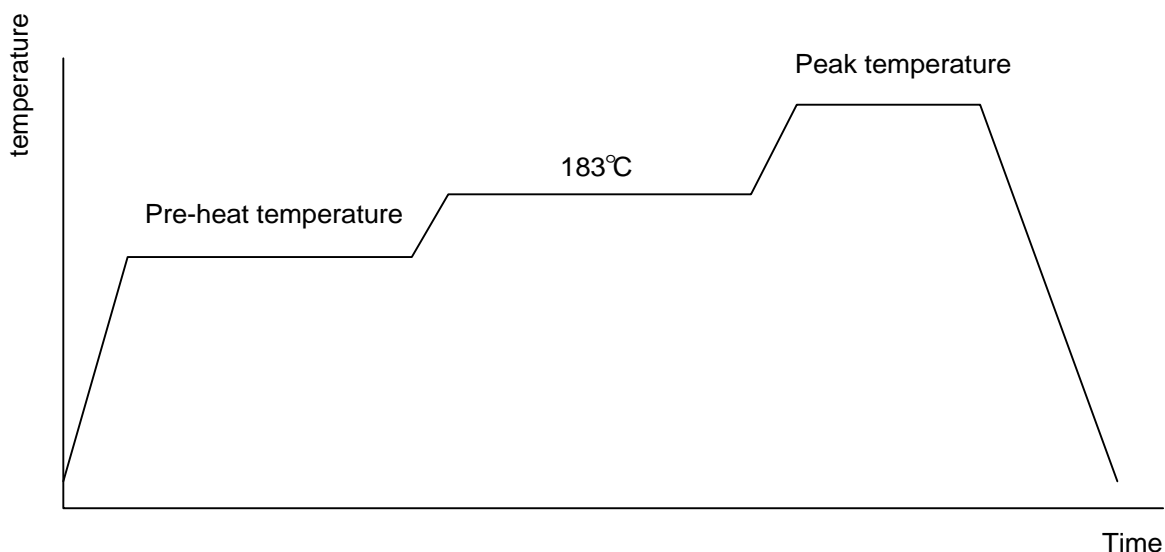

Classification Reflow Profiles

	Convection or IR/ Convection	VPR
Average ramp-up rate(183°C to Peak)	3°C/second max.	10 °C /second max.
Preheat temperature 125 ± 25°C)	120 seconds max.	
Temperature maintained above 183°C	60 ~ 150 seconds	
Time within 5°C of actual peak temperature	10 ~ 20 seconds	60 seconds
Peak temperature range	220 +5/-0°C or 235 +5/-0°C	215~ 219°C or 235 +5/-0°C
Ramp-down rate	6 °C /second max.	10 °C /second max.
Time 25°C to peak temperature	6 minutes max.	

Package Reflow Conditions

pkg. thickness ≥ 2.5mm and all bags	pkg. thickness < 2.5mm and pkg. volume ≥ 350 mm ³	pkg. thickness < 2.5mm and pkg. volume < 350mm ³
Convection 220 +5/-0 °C		Convection 235 +5/-0 °C
VPR 215-219 °C		VPR 235 +5/-0 °C
IR/Convection 220 +5/-0 °C		IR/Convection 235 +5/-0 °C

Reliability test program

Test item	Method	Description
SOLDERABILITY	MIL-STD-883D-2003	245°C, 5 SEC
HOLT	MIL-STD 883D-1005.7	1000 Hrs Bias @ 125°C
PCT	JESD-22-B, A102	168 Hrs, 100% RH, 121°C
TST	MIL-STD 883D-1011.9	-65°C ~ 150°C, 200 Cycles

Carrier Tape & Reel Dimensions

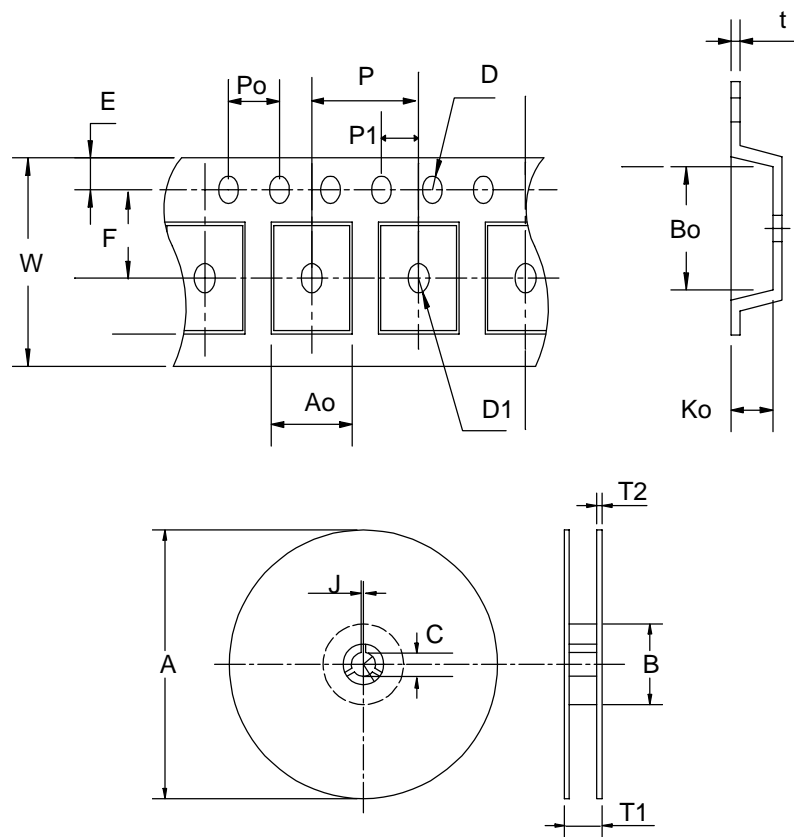

Application	A	B	C	J	T1	T2	W	P	E
SOP-8	330±1	62 ± 1.5	12.75 + 0.15	2 + 0.5	12.4 +0.2	2± 0.2	12 + 0.3 - 0.1	8± 0.1	1.75± 0.1
Application	F	D	D1	Po	P1	Ao	Bo	Ko	t
SOP-8	5.5 ± 0.1	1.55±0.1	1.55+ 0.25	4.0 ± 0.1	2.0 ± 0.1	6.4 ± 0.1	5.2± 0.1	2.1± 0.1	0.3±0.013

(mm)

Cover Tape Dimensions

Application	Carrier Width	Cover Tape Width	Devices Per Reel
SOP- 8	12	9.3	2500

Customer Service

Anpec Electronics Corp.

Head Office :

5F, No. 2 Li-Hsin Road, SBIP,

Hsin-Chu, Taiwan, R.O.C.

Tel : 886-3-5642000

Fax : 886-3-5642050

Taipei Branch :

7F, No. 137, Lane 235, Pac Chiao Rd.,

Hsin Tien City, Taipei Hsien, Taiwan, R. O. C.

Tel : 886-2-89191368

Fax : 886-2-89191369