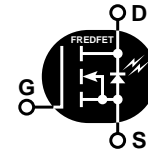
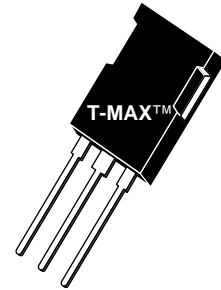

POWER MOS V®

FREDFET

Power MOS V® is a new generation of high voltage N-Channel enhancement mode power MOSFETs. This new technology minimizes the JFET effect, increases packing density and reduces the on-resistance. Power MOS V® also achieves faster switching speeds through optimized gate layout.

- Fast Recovery Body Diode
- Lower Leakage
- Faster Switching
- 100% Avalanche Tested
- New T-MAX™ Package
(Clip-mounted TO-247 Package)

MAXIMUM RATINGS

 All Ratings: $T_C = 25^\circ\text{C}$ unless otherwise specified.

| Symbol | Parameter | APT20M22B2VFR | UNIT |
|----------------|---|---------------|-------|
| V_{DSS} | Drain-Source Voltage | 200 | Volts |
| I_D | Continuous Drain Current @ $T_C = 25^\circ\text{C}$ ⑤ | 100 | Amps |
| I_{DM} | Pulsed Drain Current ① ⑤ | 400 | |
| V_{GS} | Gate-Source Voltage Continuous | ± 30 | Volts |
| V_{GSM} | Gate-Source Voltage Transient | ± 40 | |
| P_D | Total Power Dissipation @ $T_C = 25^\circ\text{C}$ | 520 | Watts |
| | Linear Derating Factor | 4.16 | W/°C |
| T_J, T_{STG} | Operating and Storage Junction Temperature Range | -55 to 150 | °C |
| T_L | Lead Temperature: 0.063" from Case for 10 Sec. | 300 | |
| I_{AR} | Avalanche Current ① ⑤ (Repetitive and Non-Repetitive) | 100 | Amps |
| E_{AR} | Repetitive Avalanche Energy ① | 50 | mJ |
| E_{AS} | Single Pulse Avalanche Energy ④ | 2500 | |

STATIC ELECTRICAL CHARACTERISTICS

| Symbol | Characteristic / Test Conditions | MIN | TYP | MAX | UNIT |
|--------------|--|-----|-----|-----------|---------------|
| BV_{DSS} | Drain-Source Breakdown Voltage ($V_{GS} = 0V, I_D = 250\mu\text{A}$) | 200 | | | Volts |
| $I_{D(on)}$ | On State Drain Current ② ⑤ ($V_{DS} > I_{D(on)} \times R_{DS(on)}$ Max, $V_{GS} = 10V$) | 100 | | | Amps |
| $R_{DS(on)}$ | Drain-Source On-State Resistance ② ($V_{GS} = 10V, 0.5 I_{D[Cont.]}$) | | | 0.022 | Ohms |
| I_{DSS} | Zero Gate Voltage Drain Current ($V_{DS} = V_{DSS}, V_{GS} = 0V$) | | | 250 | μA |
| | Zero Gate Voltage Drain Current ($V_{DS} = 0.8 V_{DSS}, V_{GS} = 0V, T_C = 125^\circ\text{C}$) | | | 1000 | |
| I_{GSS} | Gate-Source Leakage Current ($V_{GS} = \pm 30V, V_{DS} = 0V$) | | | ± 100 | nA |
| $V_{GS(th)}$ | Gate Threshold Voltage ($V_{DS} = V_{GS}, I_D = 2.5\text{mA}$) | 2 | | 4 | Volts |

 **CAUTION:** These Devices are Sensitive to Electrostatic Discharge. Proper Handling Procedures Should Be Followed.

USA

405 S.W. Columbia Street

EUROPE

Avenue J.F. Kennedy Bât B4 Parc Cadéra Nord

APT Website - <http://www.advancedpower.com>

Bend, Oregon 97702-1035

Phone: (541) 382-8028

FAX: (541) 388-0364

F-33700 Merignac - France

Phone: (33) 5 57 92 15 15

FAX: (33) 5 56 47 97 61

DYNAMIC CHARACTERISTICS

APT20M22B2VFR

| Symbol | Characteristic | Test Conditions | MIN | TYP | MAX | UNIT |
|---------------------|------------------------------|--|-----|------|-------|------|
| C _{iss} | Input Capacitance | V _{GS} = 0V | | 8500 | 10200 | pF |
| C _{oss} | Output Capacitance | V _{DS} = 25V | | 1950 | 2730 | |
| C _{rss} | Reverse Transfer Capacitance | f = 1 MHz | | 560 | 840 | |
| Q _g | Total Gate Charge ③ | V _{GS} = 10V | | 290 | 435 | nC |
| Q _{gs} | Gate-Source Charge | V _{DD} = 0.5 V _{DSS} | | 66 | 100 | |
| Q _{gd} | Gate-Drain ("Miller") Charge | I _D = I _D [Cont.] @ 25°C | | 120 | 180 | |
| t _{d(on)} | Turn-on Delay Time | V _{GS} = 15V | | 16 | 32 | ns |
| t _r | Rise Time | V _{DD} = 0.5 V _{DSS} | | 25 | 50 | |
| t _{d(off)} | Turn-off Delay Time | I _D = I _D [Cont.] @ 25°C | | 48 | 72 | |
| t _f | Fall Time | R _G = 0.6Ω | | 5 | 10 | |

SOURCE-DRAIN DIODE RATINGS AND CHARACTERISTICS

| Symbol | Characteristic / Test Conditions | MIN | TYP | MAX | UNIT |
|------------------|--|------------------------|-----|-----|-------|
| I _S | Continuous Source Current (Body Diode) | | | 100 | Amps |
| I _{SM} | Pulsed Source Current ① (Body Diode) | | | 400 | |
| V _{SD} | Diode Forward Voltage ② (V _{GS} = 0V, I _S = -I _D [Cont.]) | | | 1.5 | Volts |
| dv/dt | Peak Diode Recovery dv/dt ⑥ | | | 5 | V/ns |
| t _{rr} | Reverse Recovery Time (I _S = -I _D [Cont.], di/dt = 100A/μs) | T _j = 25°C | | 220 | ns |
| | | T _j = 125°C | | 420 | |
| Q _{rr} | Reverse Recovery Charge (I _S = -I _D [Cont.], di/dt = 100A/μs) | T _j = 25°C | 0.8 | | μC |
| | | T _j = 125°C | 3.0 | | |
| I _{RRM} | Peak Recovery Current (I _S = -I _D [Cont.], di/dt = 100A/μs) | T _j = 25°C | 10 | | Amps |
| | | T _j = 125°C | 18 | | |

THERMAL CHARACTERISTICS

| Symbol | Characteristic | MIN | TYP | MAX | UNIT |
|------------------|---------------------|-----|-----|------|------|
| R _{θJC} | Junction to Case | | | 0.24 | °C/W |
| R _{θJA} | Junction to Ambient | | | 40 | |

- ① Repetitive Rating: Pulse width limited by maximum junction temperature.
- ② Pulse Test: Pulse width < 380 μs, Duty Cycle < 2%
- ③ See MIL-STD-750 Method 3471
- ④ Starting T_j = +25°C, L = 500μH, R_G = 25Ω, Peak I_L = 100A
- ⑤ These dimensions are equal to the TO-247 without mounting hole
- ⑥ I_S ≤ -I_D [Cont.], di/dt = 100A/μs, V_{DD} ≤ V_{DSS}, T_j ≤ 150°C, R_G = 2.0Ω, V_R = 200V.

APT Reserves the right to change, without notice, the specifications and information contained herein.

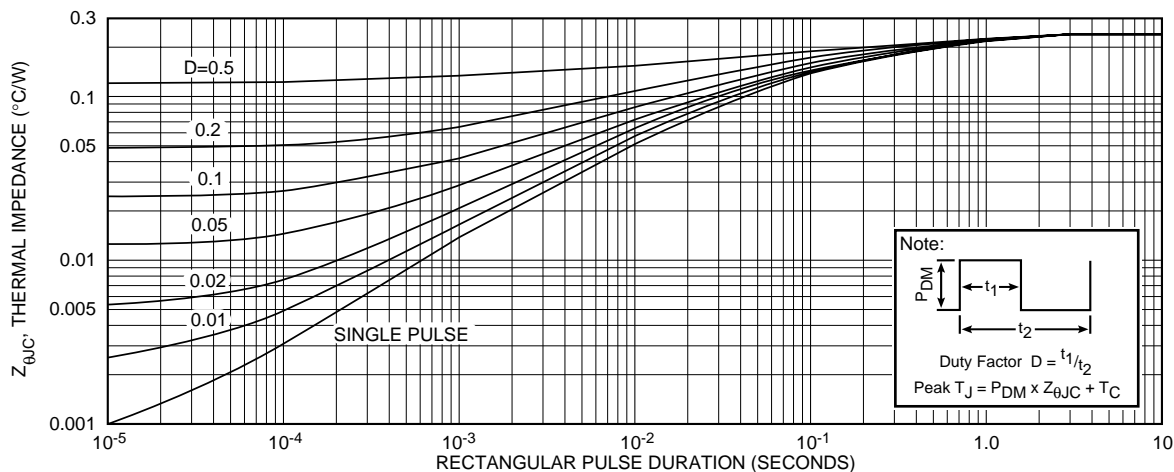

FIGURE 1, MAXIMUM EFFECTIVE TRANSIENT THERMAL IMPEDANCE, JUNCTION-TO-CASE vs PULSE DURATION

APT20M22B2VFR

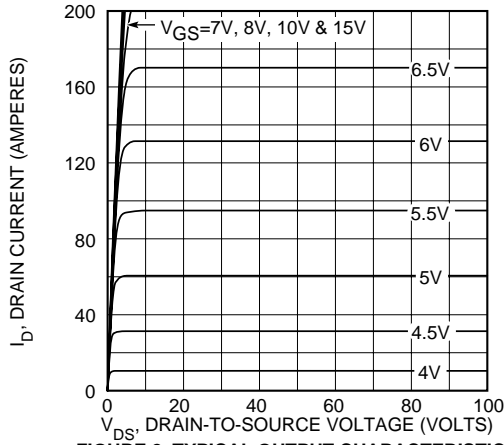

FIGURE 2, TYPICAL OUTPUT CHARACTERISTICS

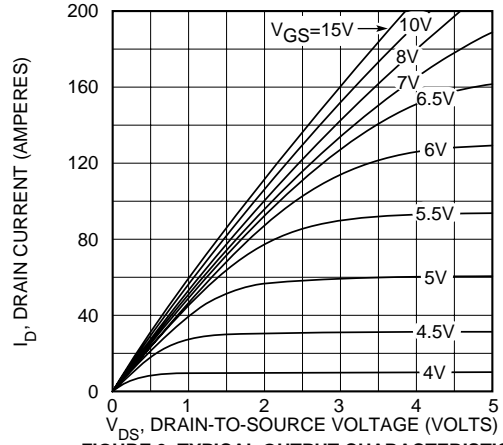

FIGURE 3, TYPICAL OUTPUT CHARACTERISTICS

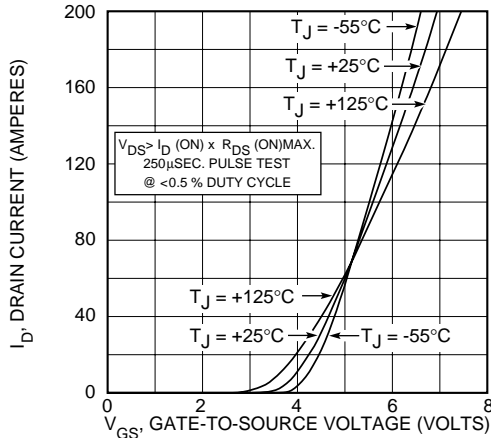

FIGURE 4, TYPICAL TRANSFER CHARACTERISTICS

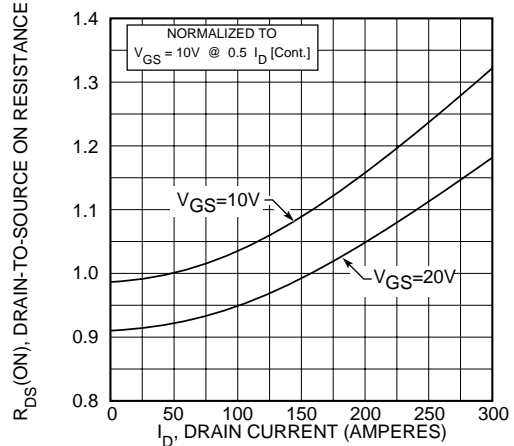

FIGURE 5, $R_{DS(ON)}$ vs DRAIN CURRENT

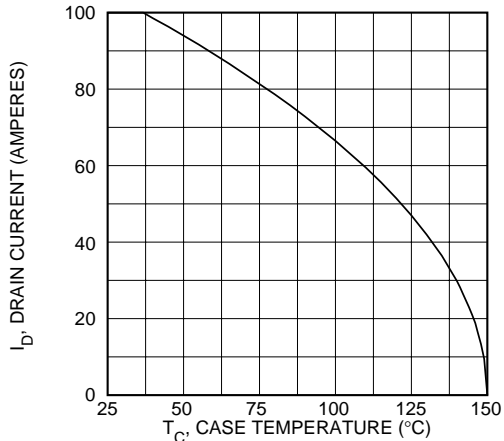

FIGURE 6, MAXIMUM DRAIN CURRENT vs CASE TEMPERATURE

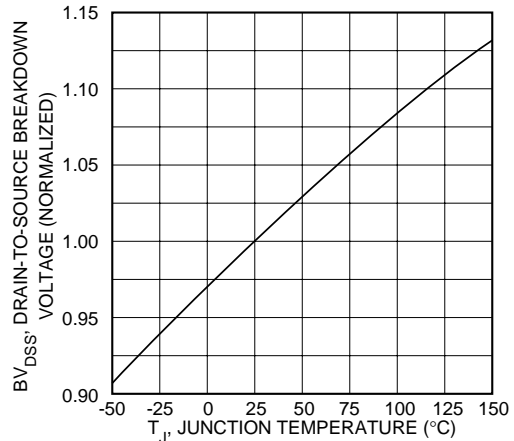

FIGURE 7, BREAKDOWN VOLTAGE vs TEMPERATURE

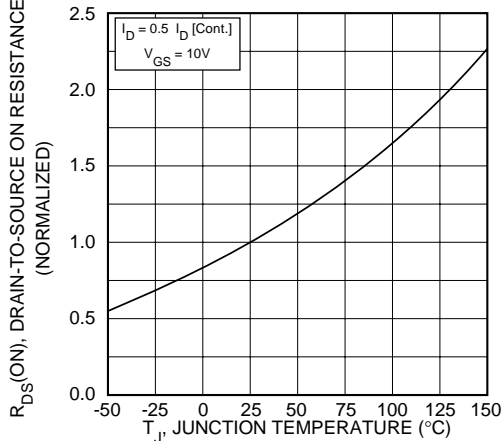

FIGURE 8, ON-RESISTANCE vs. TEMPERATURE

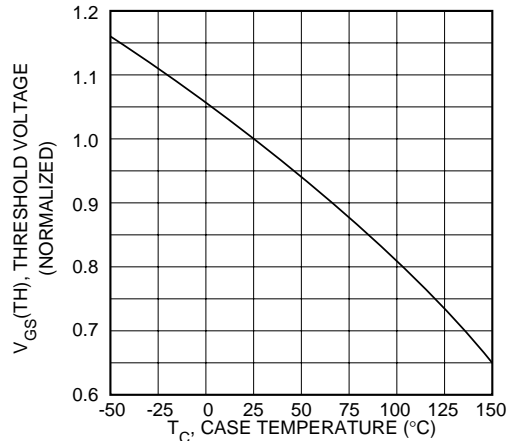

FIGURE 9, THRESHOLD VOLTAGE vs TEMPERATURE

APT20M22B2VFR

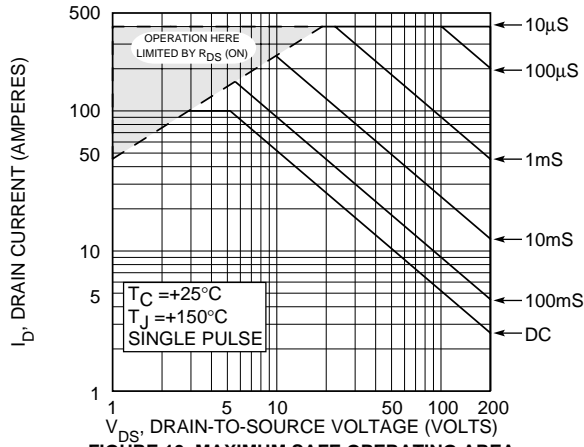

FIGURE 10, MAXIMUM SAFE OPERATING AREA

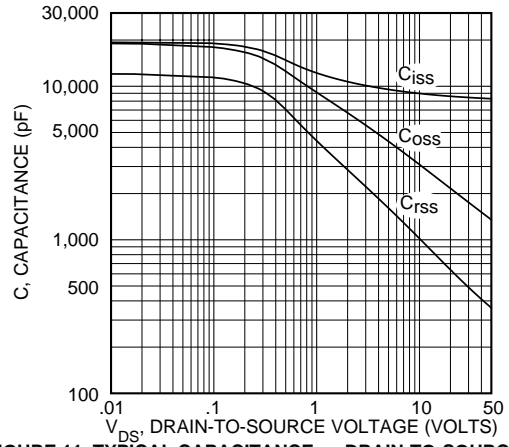

FIGURE 11, TYPICAL CAPACITANCE vs DRAIN-TO-SOURCE VOLTAGE

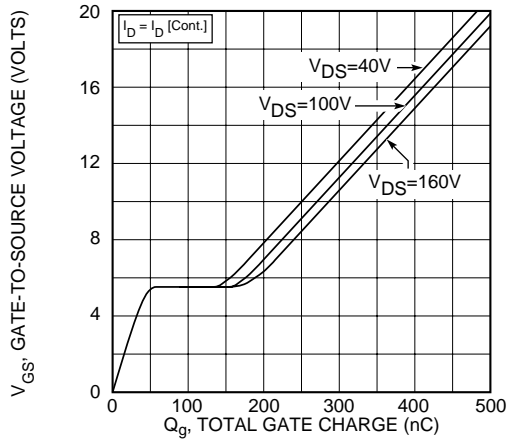

FIGURE 12, GATE CHARGES vs GATE-TO-SOURCE VOLTAGE

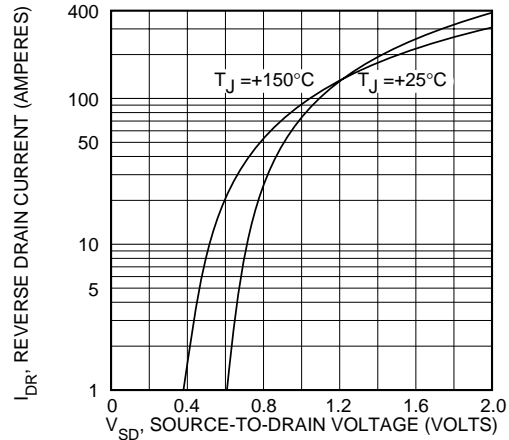
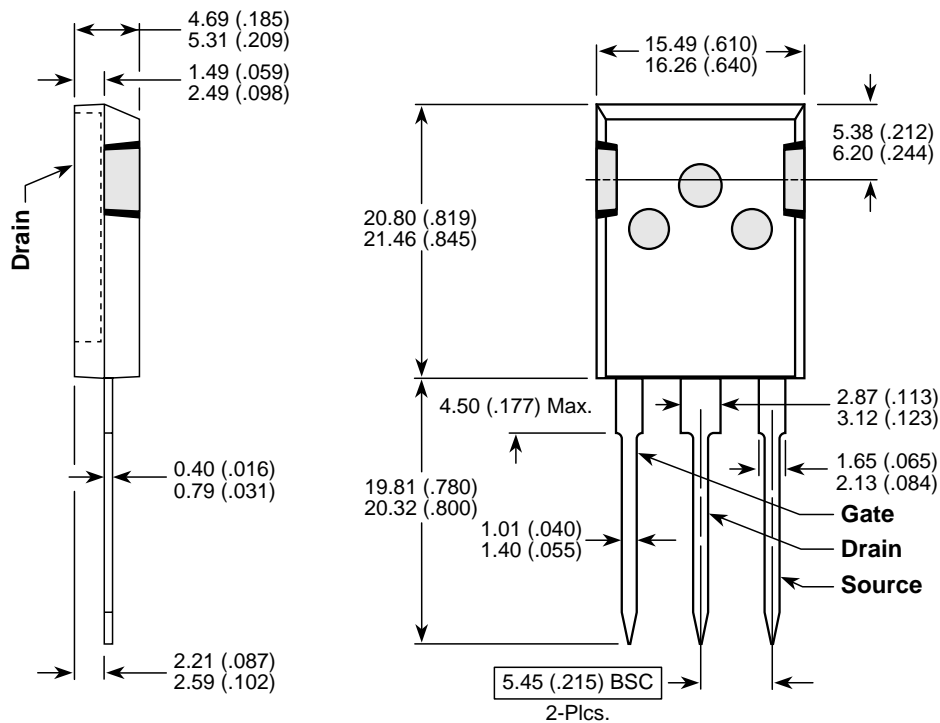

FIGURE 13, TYPICAL SOURCE-DRAIN DIODE FORWARD VOLTAGE

T-MAX™ Package Outline ⑤



Dimensions in Millimeters and (Inches)