

**Dual Buck chopper
Super Junction MOSFET
Power Module**

**$V_{DSS} = 800V$
 $R_{DSon} = 150m\Omega$ max @ $T_j = 25^\circ C$
 $I_D = 28A$ @ $T_c = 25^\circ C$**

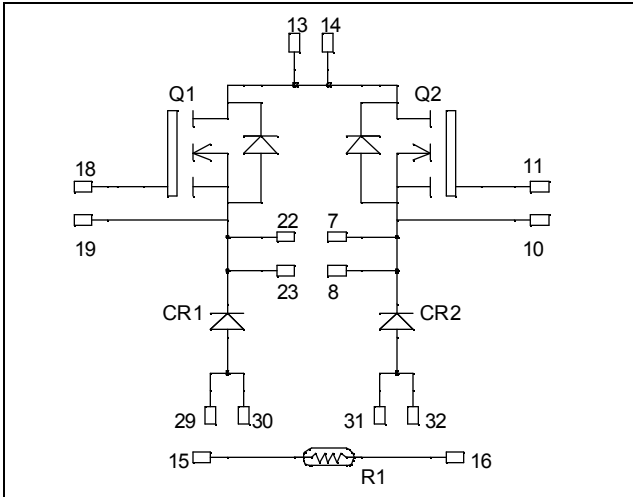

Application

- AC and DC motor control
- Switched Mode Power Supplies

Features

- **COOLMOS** Power Semiconductors
 - Ultra low R_{DSon}
 - Low Miller capacitance
 - Ultra low gate charge
 - Avalanche energy rated
 - Very rugged
- Kelvin source for easy drive
- Very low stray inductance
 - Symmetrical design
- Internal thermistor for temperature monitoring
- High level of integration

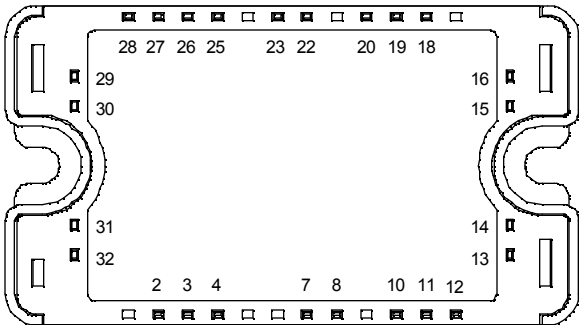

Benefits

- Outstanding performance at high frequency operation
- Direct mounting to heatsink (isolated package)
- Low junction to case thermal resistance
- Solderable terminals both for power and signal for easy PCB mounting
- Low profile
- Each leg can be easily paralleled to achieve a single buck of twice the current capability

All multiple inputs and outputs must be shorted together
Example: 13/14 ; 29/30 ; 22/23 ...

Absolute maximum ratings

Symbol	Parameter	Max ratings	Unit
V_{DSS}	Drain - Source Breakdown Voltage	800	V
I_D	Continuous Drain Current	$T_c = 25^\circ C$	28
		$T_c = 80^\circ C$	21
I_{DM}	Pulsed Drain current	110	
V_{GS}	Gate - Source Voltage	± 30	V
R_{DSon}	Drain - Source ON Resistance	150	$m\Omega$
P_D	Maximum Power Dissipation	$T_c = 25^\circ C$	277
I_{AR}	Avalanche current (repetitive and non repetitive)	24	A
E_{AR}	Repetitive Avalanche Energy	0.5	mJ
E_{AS}	Single Pulse Avalanche Energy	670	

CAUTION: These Devices are sensitive to Electrostatic Discharge. Proper Handling Procedures Should Be Followed.

All ratings @ $T_j = 25^\circ\text{C}$ unless otherwise specified

Electrical Characteristics

Symbol	Characteristic	Test Conditions	Min	Typ	Max	Unit
BV_{DSS}	Drain - Source Breakdown Voltage	$V_{GS} = 0V, I_D = 375\mu A$	800			V
I_{DSS}	Zero Gate Voltage Drain Current	$V_{GS} = 0V, V_{DS} = 800V, T_j = 25^\circ\text{C}$			50	μA
		$V_{GS} = 0V, V_{DS} = 800V, T_j = 125^\circ\text{C}$			375	
$R_{DS(on)}$	Drain - Source on Resistance	$V_{GS} = 10V, I_D = 14A$			150	$m\Omega$
$V_{GS(th)}$	Gate Threshold Voltage	$V_{GS} = V_{DS}, I_D = 2mA$	2.1	3	3.9	V
I_{GSS}	Gate - Source Leakage Current	$V_{GS} = \pm 20V, V_{DS} = 0V$			± 150	nA

Dynamic Characteristics

Symbol	Characteristic	Test Conditions	Min	Typ	Max	Unit
C_{iss}	Input Capacitance	$V_{GS} = 0V$		4507		pF
C_{oss}	Output Capacitance	$V_{DS} = 25V$		2092		
C_{rss}	Reverse Transfer Capacitance	$f = 1MHz$		108		
Q_g	Total gate Charge	$V_{GS} = 10V$ $V_{Bus} = 400V$ $I_D = 28A$		180		nC
Q_{gs}	Gate - Source Charge			22		
Q_{gd}	Gate - Drain Charge			90		
$T_{d(on)}$	Turn-on Delay Time	Inductive switching @125°C $V_{GS} = 15V$ $V_{Bus} = 533V$ $I_D = 28A$ $R_G = 2.5\Omega$		10		ns
T_r	Rise Time			13		
$T_{d(off)}$	Turn-off Delay Time			83		
T_f	Fall Time			35		
E_{on}	Turn-on Switching Energy ❶	Inductive switching @ 25°C $V_{GS} = 15V, V_{Bus} = 533V$ $I_D = 28A, R_G = 2.5\Omega$		486		μJ
E_{off}	Turn-off Switching Energy ❷			278		
E_{on}	Turn-on Switching Energy ❶	Inductive switching @ 125°C $V_{GS} = 15V, V_{Bus} = 533V$ $I_D = 28A, R_G = 2.5\Omega$		850		μJ
E_{off}	Turn-off Switching Energy ❷			342		

Diode ratings and characteristics

Symbol	Characteristic	Test Conditions	Min	Typ	Max	Unit
V_{RRM}	Maximum Peak Repetitive Reverse Voltage		1000			V
I_{RM}	Maximum Reverse Leakage Current	$V_R = 1000V$	$T_j = 25^\circ\text{C}$		250	μA
			$T_j = 125^\circ\text{C}$		500	
$I_{F(AV)}$	Maximum Average Forward Current	50% duty cycle, $T_c = 100^\circ\text{C}$		60		A
V_F	Diode Forward Voltage	$I_F = 60A$		1.9	2.5	V
		$I_F = 120A$		2.2		
		$I_F = 60A, T_j = 125^\circ\text{C}$		1.7		
t_{rr}	Reverse Recovery Time	$I_F = 60A$ $V_R = 667V$ $di/dt = 200A/\mu s$	$T_j = 25^\circ\text{C}$	280		ns
			$T_j = 125^\circ\text{C}$	350		
Q_{rr}	Reverse Recovery Charge	$I_F = 60A$ $V_R = 667V$ $di/dt = 200A/\mu s$	$T_j = 25^\circ\text{C}$	760		nC
			$T_j = 125^\circ\text{C}$	3600		

❶ E_{on} includes diode reverse recovery.

❷ In accordance with JEDEC standard JESD24-1.

Thermal and package characteristics

Symbol	Characteristic	Min	Typ	Max	Unit
R _{thJC}	Junction to Case	IGBT		0.45	°C/W
		Diode		0.9	
V _{ISOL}	RMS Isolation Voltage, any terminal to case t = 1 min, I _{isol} < 1mA, 50/60Hz	2500			V
T _J	Operating junction temperature range	-40		150	°C
T _{STG}	Storage Temperature Range	-40		125	
T _C	Operating Case Temperature	-40		100	
Torque	Mounting torque		To heatsink	M4	
Wt	Package Weight			4.7	N.m
				110	g

Temperature sensor NTC

Symbol	Characteristic	Min	Typ	Max	Unit
R ₂₅	Resistance @ 25°C		68		kΩ
B _{25/85}	T ₂₅ = 298.16 K		4080		K

$$R_T = \frac{R_{25}}{\exp \left[B_{25/85} \left(\frac{1}{T_{25}} - \frac{1}{T} \right) \right]}$$

T: Thermistor temperature
R_T: Thermistor value at T

Package outline

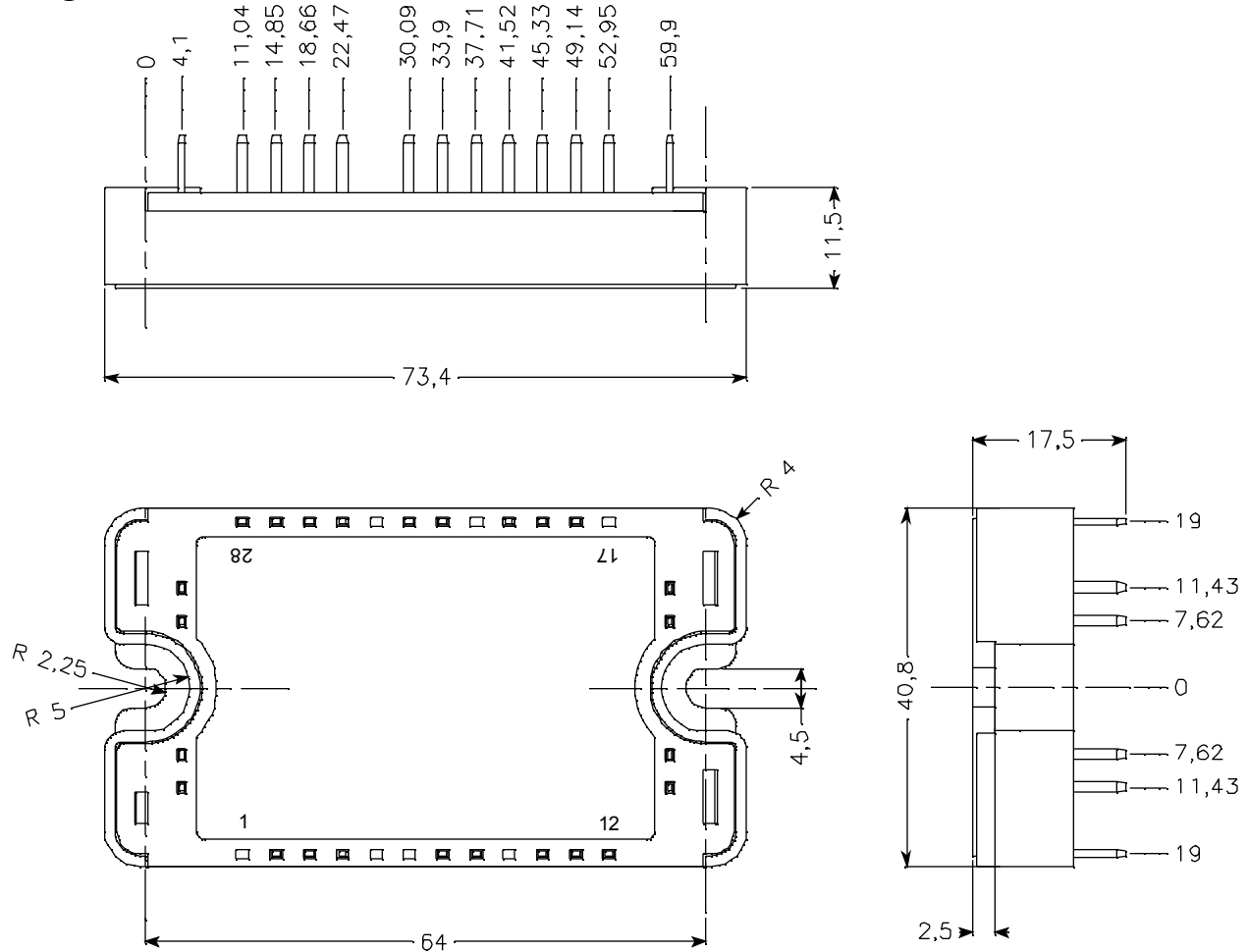

Typical Performance Curve

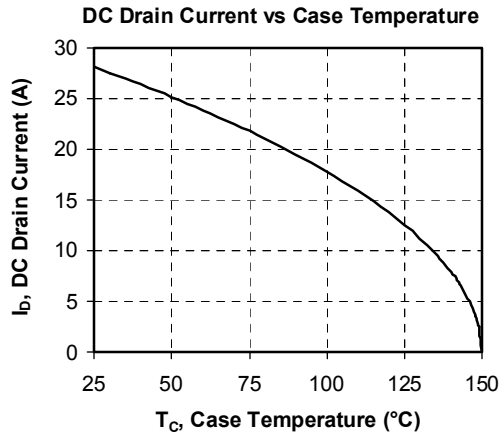
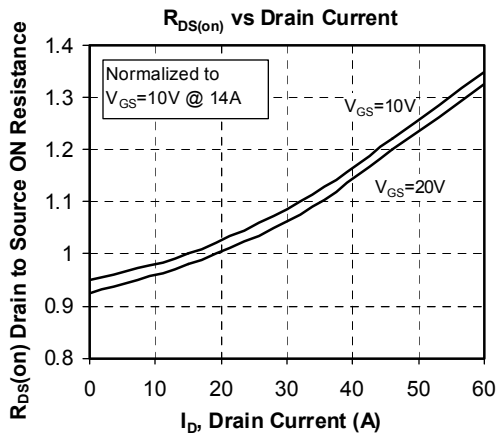
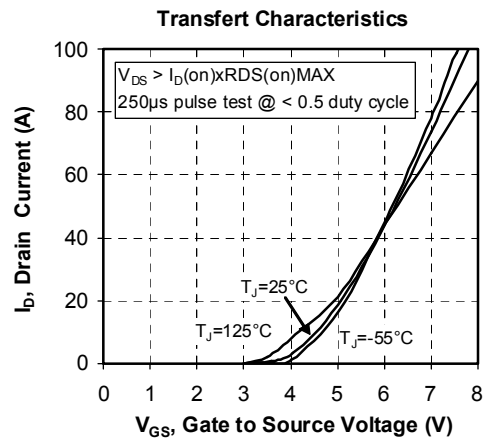
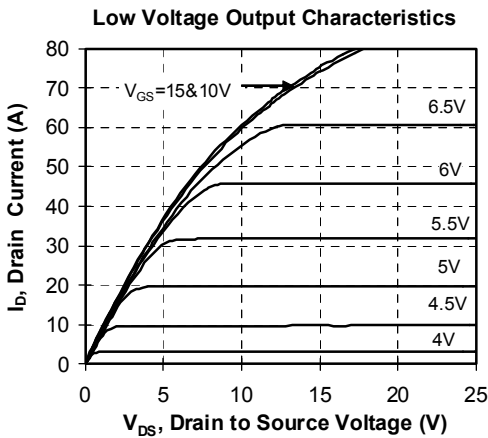
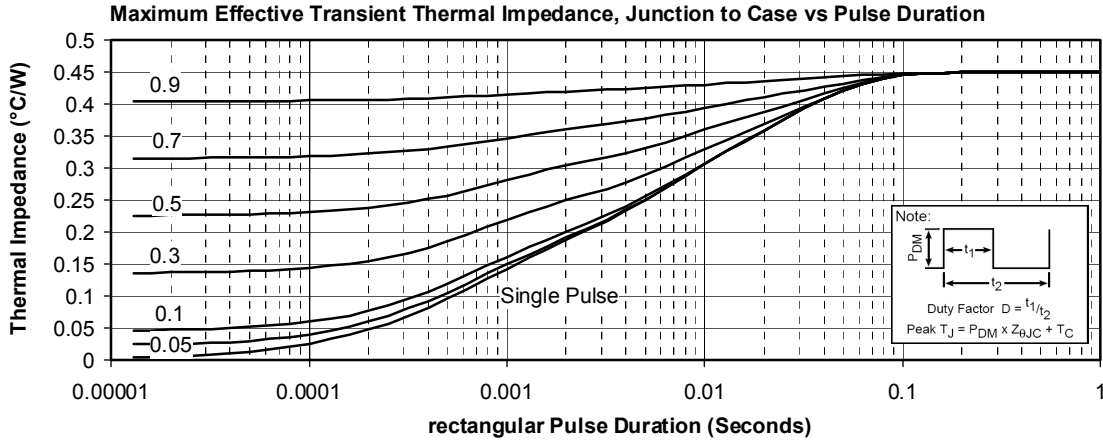

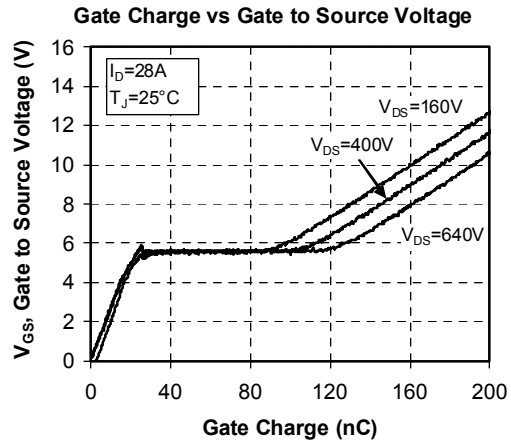
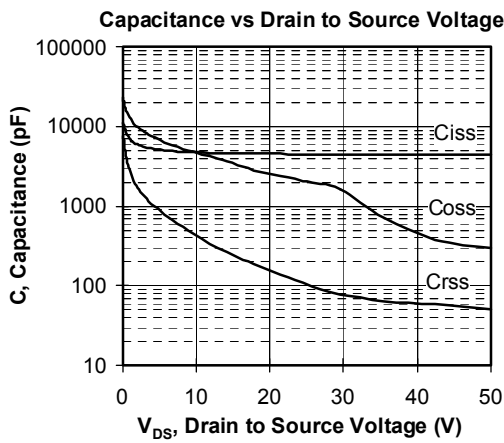
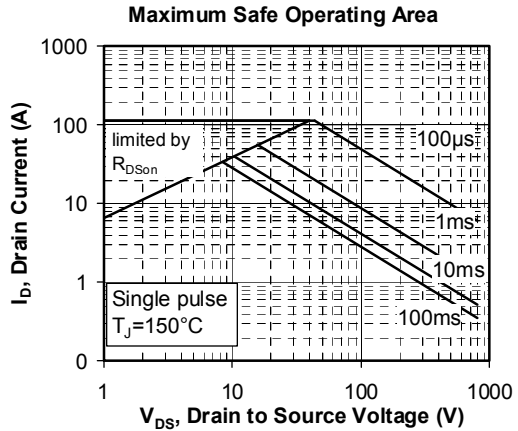
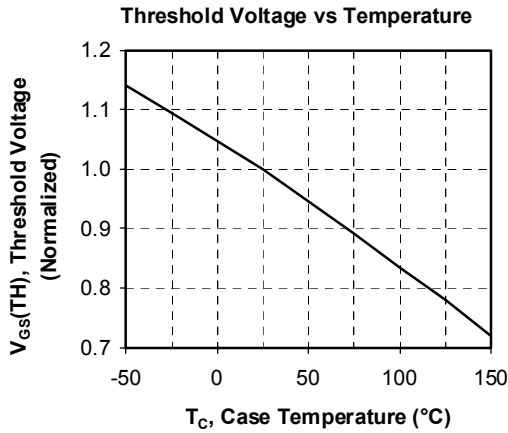
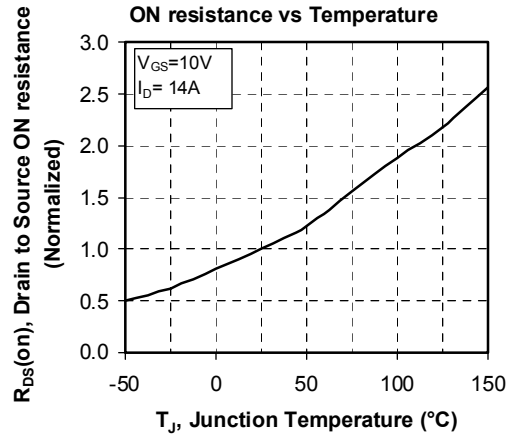
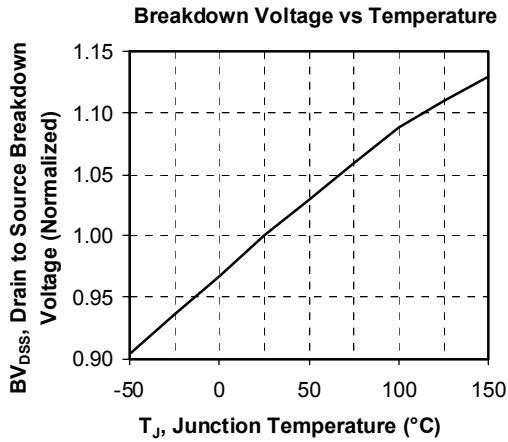

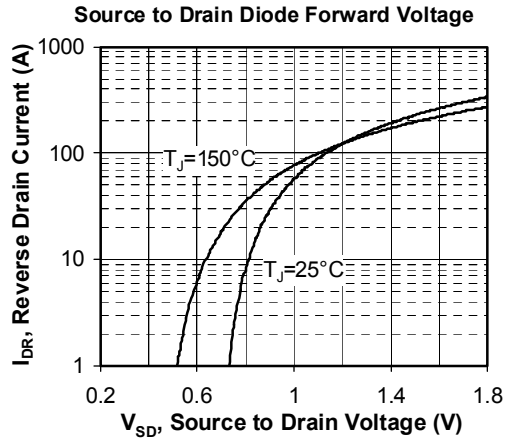
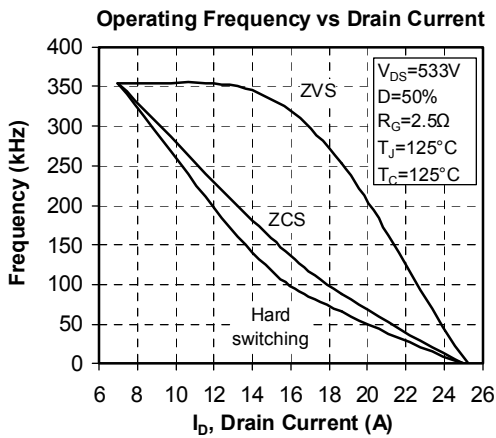
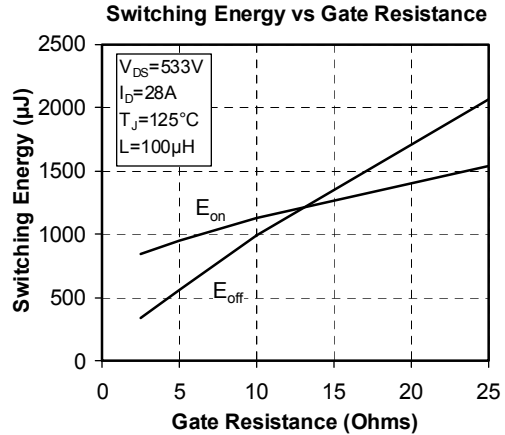
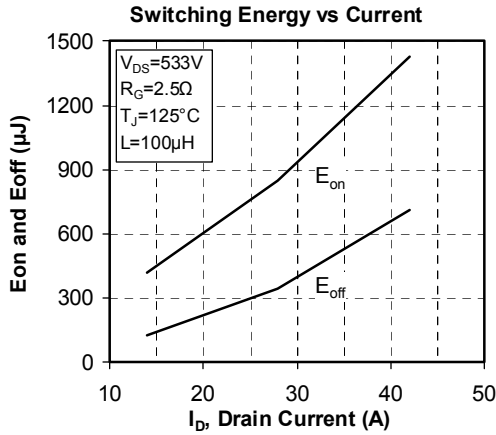
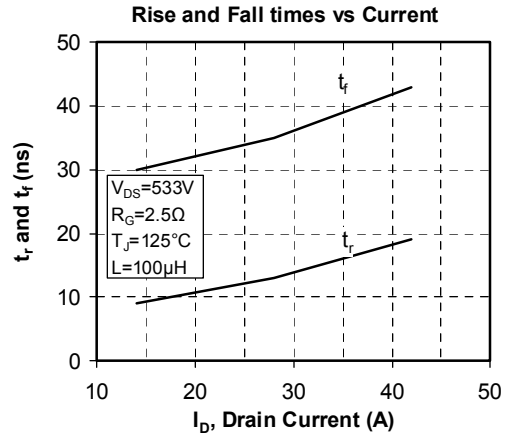
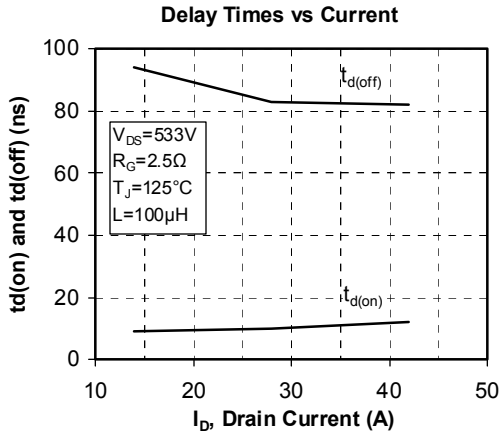

“COOLMOS™” comprise a new family of transistors developed by Infineon Technologies AG. “COOLMOS” is a trademark of Infineon Technologies AG”.

APT reserves the right to change, without notice, the specifications and information contained herein

APT's products are covered by one or more of U.S. patents 4,895,810 5,045,903 5,089,434 5,182,234 5,019,522 5,262,336 6,503,786 5,256,583 4,748,103 5,283,202 5,231,474 5,434,095 5,528,058 and foreign patents. U.S and Foreign patents pending. All Rights Reserved.