

AZ DISPLAYS, INC.

SPECIFICATIONS FOR STANDARD RESISITIVE TOUCH PANEL

PART NUMBER:

ATP154-1

DATE:

September 14, 2004

STANDARD Resistive Touch Panel Specification 4-Wire Series

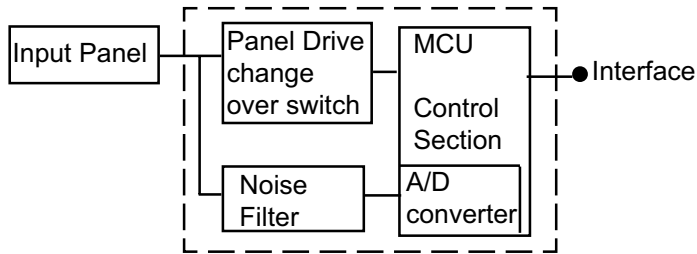

- **FEATURES**
- Superior quality standard 4 wire resistive analog touch panel
- Excellent specification and high quality
 - Anti Newton ring technology
 - High reliability materials
- Pen/finger type
- Transparency - 80%
- **PART NUMBER**

Part Number	Size	Type
ATP154-1	15.0"	Pen / Finger

- **DETAILED SPECIFICATION**

- **1.0 APPLICATION**

This specification applies to the 5.7" (inch) standard TOUCH PANEL (Pen/Finger type).
The part number of this panel is ATP0574-1.

- **2.0 DISCRPTION AND BLOCK DIAGRAM**

This panel in combination with a control IC chip is used to transfer the co-ordinates of the touched position to the host system (see block diagram on previous page).

- **3.0 DRAWING**

Please see dimension drawing.

Definitions of the major dimensions indicated on this diagram:

Effective Input Area (A) Area guaranteed to meet all the characteristics detailed in this specification

Anti-input Area (C) An insulating area allowed to protect the touch panel from giving false readings when an enclosure touches the panel. (See fixing instructions)

- **4.0 CHARACTERISTICS**

- • **4.1 MECHANICAL**

Operating Force 0.05~0.49 N (5 ~ 50gF) Measured with a Silicon Measurement Rod R 8 (Round type 8mm) Silicon Rubber with hardness at 60°C

Hardness of Surface Pencil hardness 2H minimum against specification JIS K-5400

- • **4.2 OPTICAL**

Transparency 78% min. measured in the effective input area to JIS K 7105 using a MURAKAMI SHIKISAI KENKYUSHO type IIR 100 meter.

Haze 5% type measured in the effective input area using a MURAKAMI SHIKISAI KENKYUSHO type IIR 100 meter with an Anti Glare treated surface.

- • **4.3 ELECTRICAL**

Rated Voltage:	DC 7V max.
Resistance X axis:	300 to 850 Ω (at the connector)
Resistance Y axis:	100 to 600 Ω (at the connector)
Switch Bounce (Chattering):	20ms min when using the silicon rubber measurement rod
Insulation resistance:	10MΩ minimum at 25KV DC
Dielectric Strength:	No problems when at 25KV DC for 1 minute
Linearity:	2% max.

Note 1:

Measurement condition of linearity is corrected within the control IC. In general the location accuracy is specified as follows:

Actual co-ordinate point - theoretical co-ordinate point = location accuracy.

In general a 9 point co-ordinate calibration system is used to adjust the micro controller accuracy. (20 points can be used in combination with an EEPROM design).

• • 4.4 ENVIRONMENTAL

- Operating Temperature (*):** -0°C to 50°C
- Storage Temperature:** -20°C to 70°C
- Operating Humidity:** 20% to 85% RH with a Maximum wet bulb temperature of 38°C
- Storage Humidity:** 10% to 90% RH with a Maximum wet bulb temperature of 38°C
- Chemical Resistance:** Coating with the following chemicals and storing at room temperature for 2 hours gives no problems. 10% NaCl-water solution, ethyl-acetate, ethyl-alcohol, toluene, methyl-ethyl-ketone
- Low Air Pressure:** No issues down to 0.5 x Normal Air pressure

• • 4.5 PEN LIFE

- Note taking life:** 100,000 words minimum
- Input life :** 1,000,000 times minimum

Note 1:

Words are written in the notes area and the size of the word is 7.5mm x 6.75mm. A word is any Alphabet / Number / Mark. A pen applies a force of 250g. A failure is judged to happen when the current consumption or insulation resistance or dielectric strength are not met as shown in 4.3. The location accuracy with 9 point calibration must be ± 4.4 mm max.

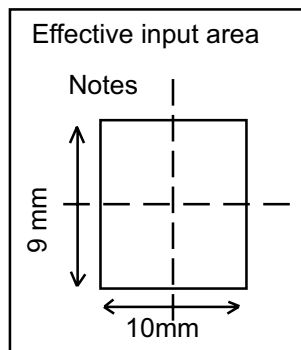

• • 4.6 FINGER LIFE

A finger is simulated by a silicon rubber plunger R8 (Round type 8mm size) hardness 60°C at 200g at frequency 5Hz.

A failure is judged to happen when the current consumption or insulation resistance or dielectric strength are not met as shown in 5.3. The location accuracy with 9 point calibration must be ± 4.4 mm max. Operating force is 150g max.

• • 5.0 REJECT CRITERIA

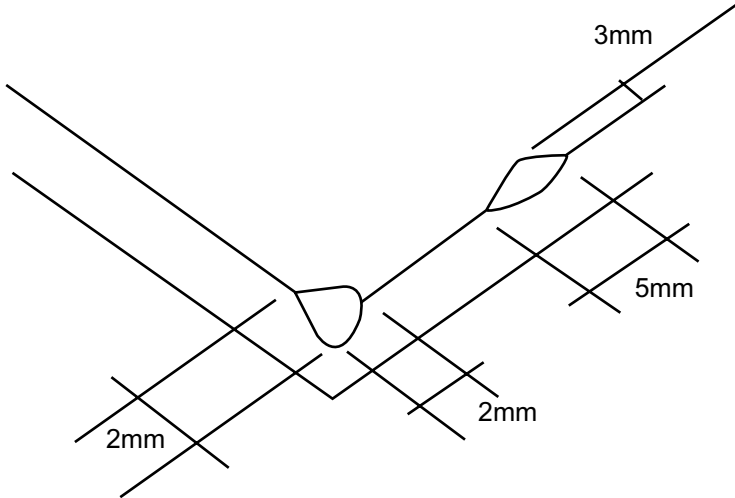
Description		Reject Criteria
Film Dent		Area $\geq 0.1\text{mm}^2$: to be zero Area $\geq 0.05\text{mm}^2$ & area $< 0.1\text{mm}^2$: to be max. 5 points Area $< 0.05\text{mm}^2$: none specified
Foreign material between glass and film	Dot type	Area $> 0.1\text{mm}^2$: to be zero Area $\geq 0.05\text{mm}^2$ & area $< 0.1\text{mm}^2$: to be max. 5 points Area $< 0.05\text{mm}^2$: none specified
	Line type	Area $\geq 0.1\text{mm}$: to be zero Area $\geq 0.03\text{mm}$ & width $< 0.1\text{mm}$ and length $< 10\text{mm}$: to be max. 1 point Area $< 0.05\text{mm}$: none specified
Scratch		Area $\geq 0.1\text{mm}$: to be zero Area $\geq 0.03\text{mm}$ & width $< 0.1\text{mm}$ with length $< 80\text{mm}$: to be max. 1 point Area $< 0.03\text{mm}$ & width $< 0.1\text{mm}$ with length $< 30\text{mm}$: none specified
Dot blur or hard coat missing		Area $\geq 0.5\text{mm}^2$: to be zero Area $\geq 0.03\text{mm}^2$ & area $< 0.5\text{mm}^2$: to be max. 5 points Area $< 0.05\text{mm}^2$: none specified
Newton Ring		These must not be seen from Panel film side under a fluorescent lamp (3 wavelength type lamp). Not to be verified form glass side.
Glass flaw		To be no flaw which is bigger than that shown in the following diagram. The number of flaws is not specified. 

• • 6.0 GENERAL POINTS OF CAUTION

Touch panels are made of glass, so care must be taken in handling them. Do not stress, pile, bend, lift by the cable or put any stress on the film, for example moving by film face vacuum. In order to clean wring dry a cloth which has been emersed in a natural detergent. DO NOT use any organic solvent, acid or alkali solution. Watch the edge of the panel when cleaning, again for safety reasons.

6.0 CONNECTION AND MOUNTING

The details below indicate the recommended mounting structure for panel and enclosure. The enclosure support to fix the touch panel must be over 1.0mm width and must be outside the view (Transparent area). Also ensure that the enclosure does not cause miss input by touching the view area.

The following diagram shows that the enclosure edge must be between the View area and the guaranteed active area. Ensure space is allocated for the diodes, and we recommend that the material to fix the panel and enclosure is elastic. Special design would be required to stop water ingress. The corners of the touch panel are conductive so do not touch any metal parts after mounting.

Top View (Picture, with conductive side down)

- | Location | Detect |
|----------|--------|
| 1. | Bottom |
| 2. | Left |
| 3. | Top |
| 4. | Right |

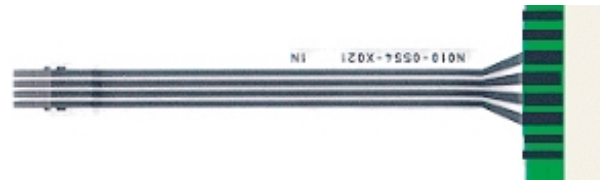
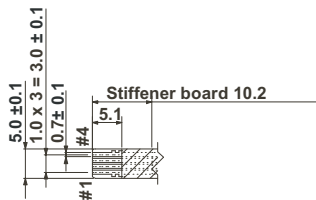

(Drawing) with conductive connector and glass side down. See page 1 for detail of connector exit side which is left.

(Mating connector type SFW4R-1ST: for FPC)

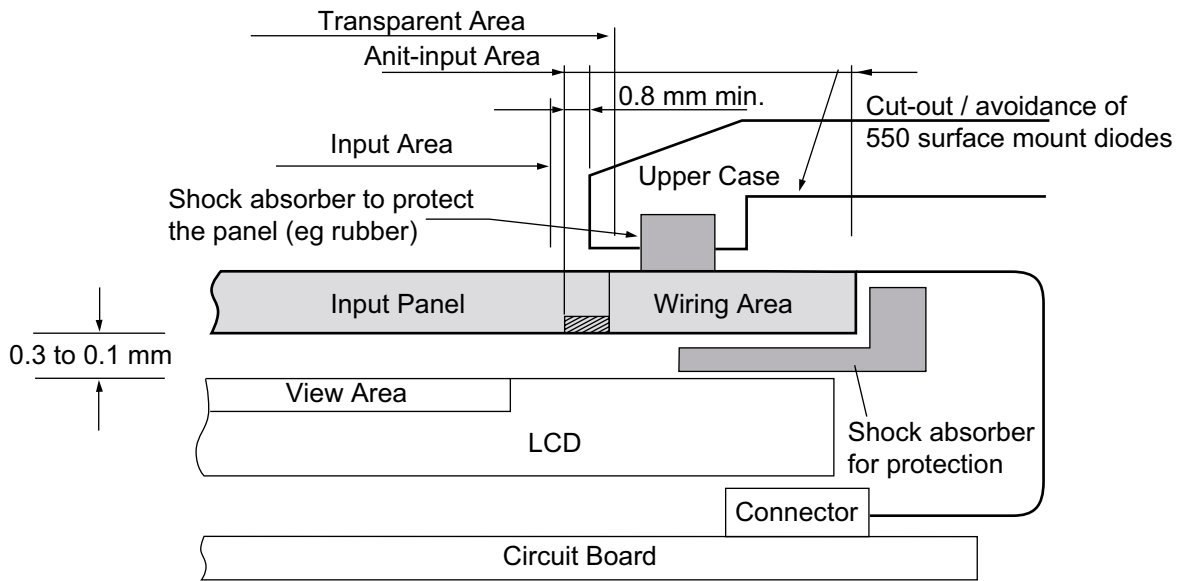

7.0 PANEL THICKNESS (typical)

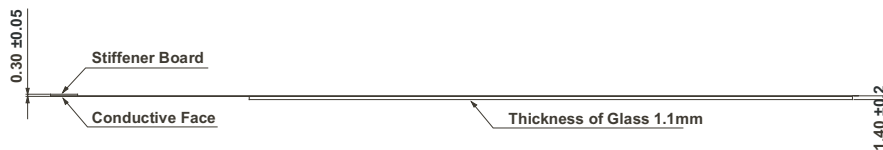

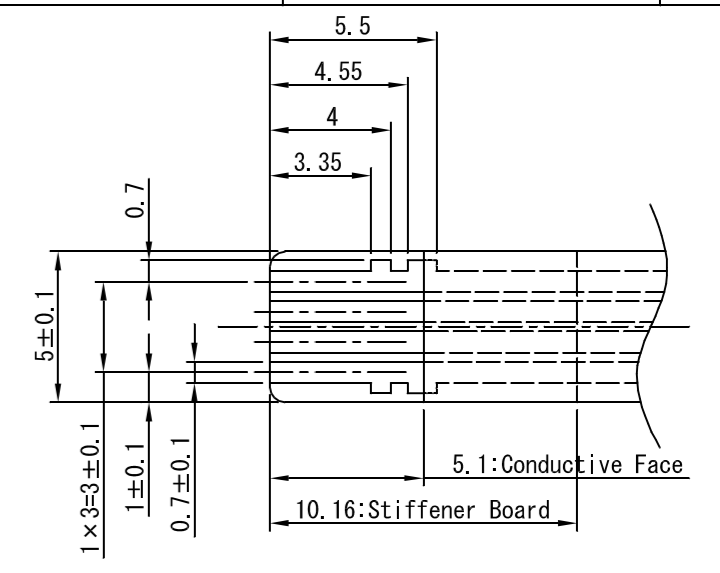
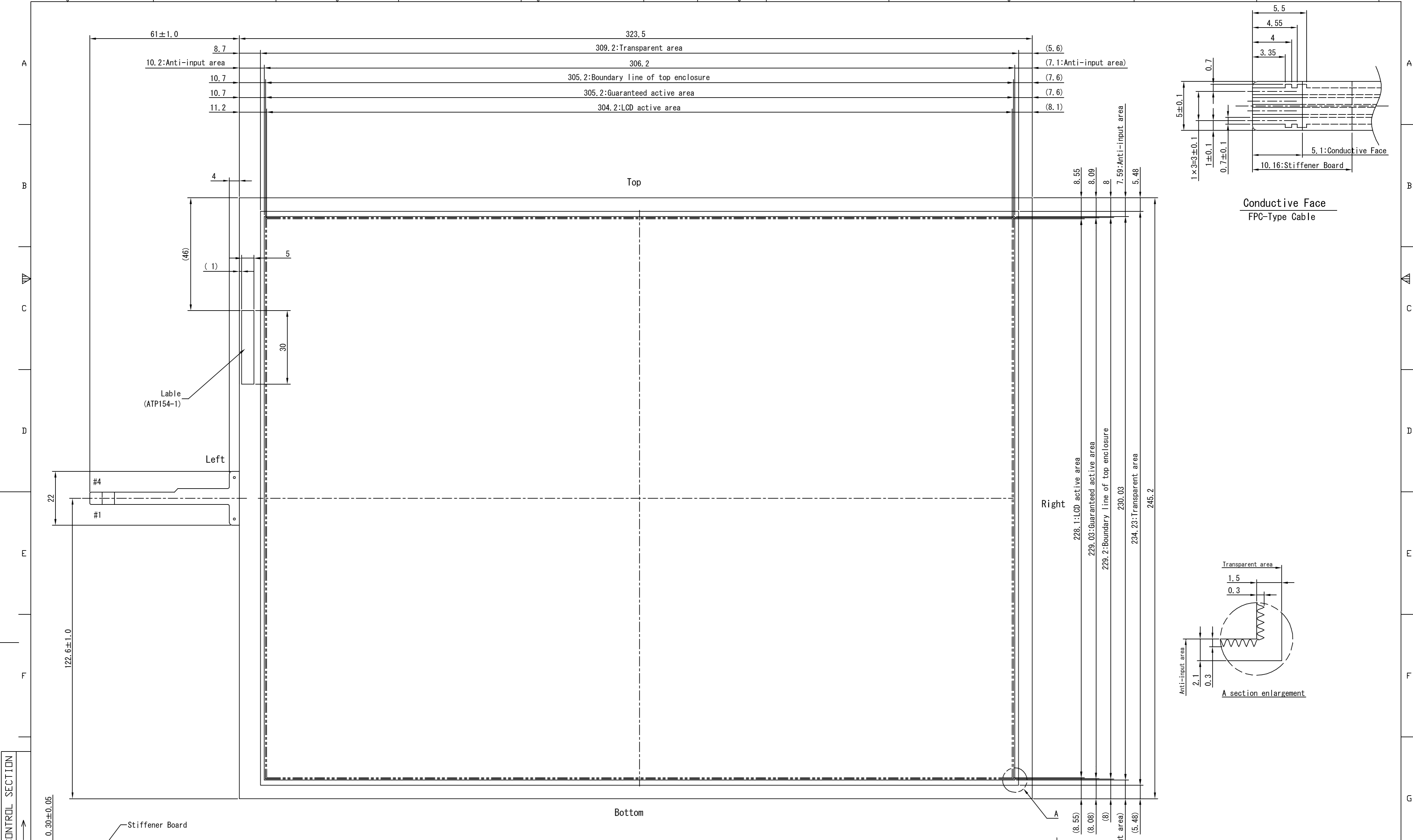

Conductive Face
FPC-Type Cable

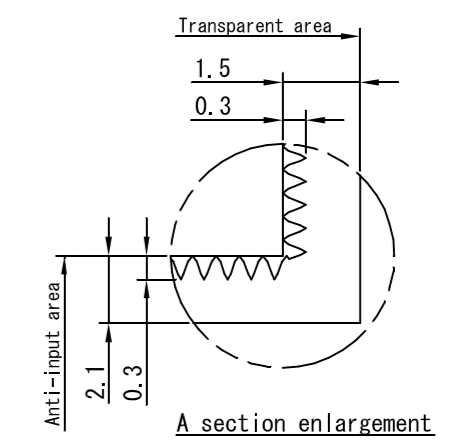

Generally Specs.	
Transparency	80%Typ.
HAZE	8% Typ.
Pen Life	100,000 words min.
Finger Life	1,000,000 times min.
Linearity	2.0% max.[initial value]
	4.0% max.[after environmental & life test]

Connector Pin Assignment	
Pin #	Description
#1	Bottom
#2	Left
#3	Top
#4	Right

- NOTE
1. Tolerance: ±0.5.
 2. Pen & Finger input type.
 3. Cable contact is Au. (Pb free)

TITLE				Touch Panel	
DRAW. NO.				XXJ-664	
CUST.					
EDIT.	DATE	DESIG.	CHECK	DESCRIPTION	
DESIG.	20040801	T. Nakajima	CHECK	APPR.	AZ
				1/1	

DATE DOCUMENT CONTROL SECTION