

### FEATURES

- InGaP HBT Technology
- High Efficiency: 37%
- Low Quiescent Current: 50 mA
- Low Leakage Current in Shutdown Mode: <math><1 \mu\text{A}</math>
- Optimized for a 50  $\Omega$  System
- Low Profile Miniature Surface Mount Package: 1.56mm Max
- CDMA 1XRTT Compliant
- CDMA 1xEV-DO Compliant

### APPLICATIONS

- PCS CDMA Wireless Handsets
- Dual Band CDMA Wireless Handsets
- Tri Mode CDMA Handsets with GPS

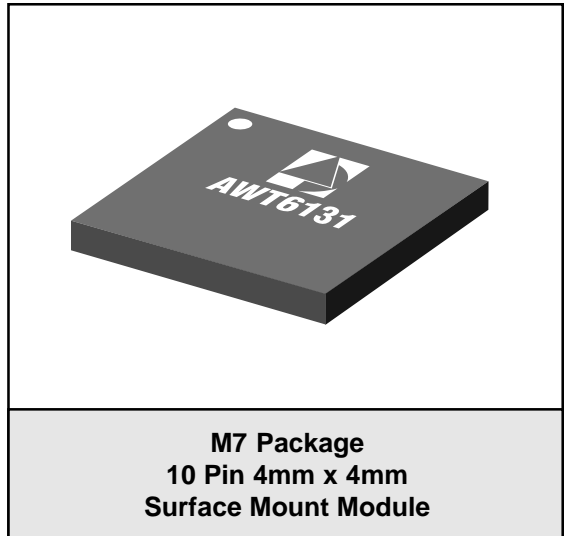

### PRODUCT DESCRIPTION

The AWT6131 provides the additional output power margin RF designers need to overcome additional post-PA insertion loss in tri-mode handset designs supporting E911 (GPS enabled). The device is manufactured on an advanced InGaP HBT MMIC technology offering state-of-the-art reliability, temperature stability, and ruggedness. Selectable

bias modes that optimize efficiency for different output power levels, and a shutdown mode with low leakage current, increase handset talk and standby time. The self-contained 4mm x 4mm surface mount package incorporates matching networks optimized for output power, efficiency, and linearity in a 50  $\Omega$  system.

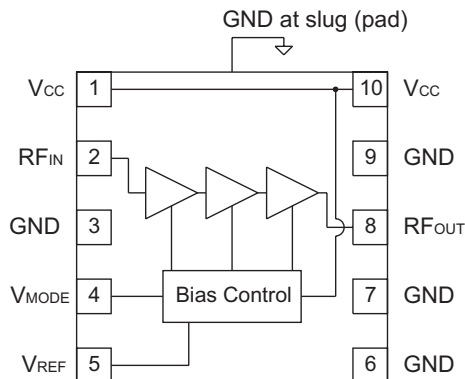

**Figure 1: Block Diagram**

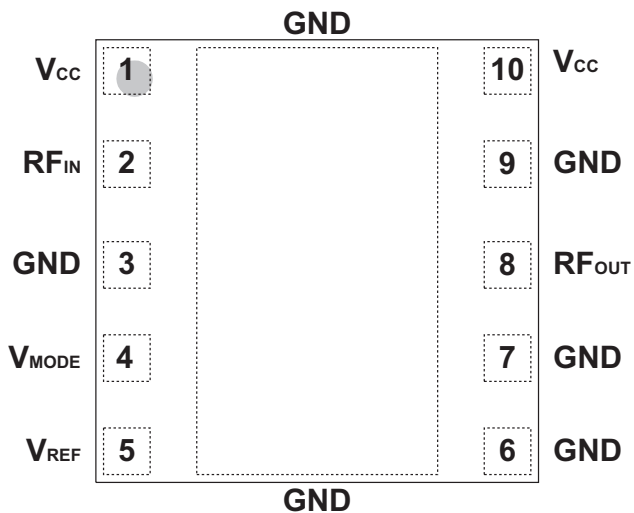

Figure 2: Pinout (X-ray Top View)

Table 1: Pin Description

PIN	NAME	DESCRIPTION
1	$V_{CC}$	Supply Voltage
2	$RF_{IN}$	RF Input
3	GND	Ground
4	$V_{MODE}$	Mode Control Voltage
5	$V_{REF}$	Reference Voltage
6	GND	Ground
7	GND	Ground
8	$RF_{OUT}$	RF Output
9	GND	Ground
10	$V_{CC}$	Supply Voltage

## ELECTRICAL CHARACTERISTICS

Table 2: Absolute Minimum and Maximum Ratings

PARAMETER	MIN	MAX	UNIT
Supply Voltage ( $V_{CC}$ )	0	+5	V
Mode Control Voltage ( $V_{MODE}$ )	0	+3.5	V
Reference Voltage ( $V_{REF}$ )	0	+3.5	V
RF Input Power ( $P_{IN}$ )	-	+10	dBm
Storage Temperature ( $T_{STG}$ )	-40	+150	°C

Stresses in excess of the absolute ratings may cause permanent damage. Functional operation is not implied under these conditions. Exposure to absolute ratings for extended periods of time may adversely affect reliability.

Table 3: Operating Ranges

PARAMETER	MIN	TYP	MAX	UNIT	COMMENTS
Operating Frequency (f)	1850	-	1910	MHz	
Supply Voltage ( $V_{CC}$ )	+3.2	+3.5	+4.2	V	
Reference Voltage ( $V_{REF}$ )	+2.8 0	+2.9 -	+3.1 +0.5	V	PA "on" PA "shut down"
Mode Control Voltage ( $V_{MODE}$ )	+2.5 0	+2.9 -	+3.1 +0.5	V	Low Bias Mode High Bias Mode
RF Output Power ( $P_{OUT}$ )	+29.0	-	-	dBm	
Case Temperature ( $T_C$ )	-30	-	+85	°C	

The device may be operated safely over these conditions; however, parametric performance is guaranteed only over the conditions defined in the electrical specifications.

**Table 4: Electrical Specifications**  
**(T<sub>C</sub> = +25 °C, V<sub>CC</sub> = +3.5 V, V<sub>REF</sub> = +2.9 V, 50 Ω system)**

PARAMETER	MIN	TYP	MAX	UNIT	COMMENTS
Gain	26 23.5	28 25	30 27.5	dB	P <sub>OUT</sub> = +29 dBm, V <sub>MODE</sub> = 0 V P <sub>OUT</sub> = +16 dBm, V <sub>MODE</sub> = +2.9 V
Adjacent Channel Power at ±1.25 kHz offset Primary Channel BW = 1.23 MHz Adjacent Channel BW = 30 kHz	- -	-48 -50	-46.5 -46.5	dB	P <sub>OUT</sub> = +29 dBm, V <sub>MODE</sub> = 0 V P <sub>OUT</sub> = +16 dBm, V <sub>MODE</sub> = +2.9 V
Adjacent Channel Power at ±2.25 MHz offset Primary Channel BW = 1.23 MHz Adjacent Channel BW = 30 kHz	- -	-61 -65	-57 -57	dB	P <sub>OUT</sub> = +29 dBm, V <sub>MODE</sub> = 0 V P <sub>OUT</sub> = +16 dBm, V <sub>MODE</sub> = +2.9 V
Power-Added Efficiency	35.5 6.5	37 7.5	- -	%	P <sub>OUT</sub> = +29 dBm, V <sub>MODE</sub> = 0 V P <sub>OUT</sub> = +16 dBm, V <sub>MODE</sub> = +2.9 V
Quiescent Current (I <sub>cq</sub> )	-	50	60	mA	V <sub>MODE</sub> = +2.9 V
Reference Current	-	6.5	9	mA	through V <sub>REF</sub> pin
Mode Control Current	-	0.3	0.5	mA	through V <sub>MODE</sub> pin
Leakage Current	-	<1	5	μA	V <sub>CC</sub> = +4.2 V, V <sub>REF</sub> = 0 V V <sub>MODE</sub> = 0 V
Noise in Receive Band	-	-135	-133	dBm/Hz	1930 MHz to 1990 MHz
Harmonics 2fo 3fo, 4fo	- -	-40 -55	-30 -30	dBc	
Input Impedance	-	-	2:1	VSWR	
Spurious Output Level (all spurious outputs)	-	-	-65	dBc	P <sub>OUT</sub> ≤ +29 dBm In-band load VSWR < 8:1 Out-of-band load VSWR < 8:1 Applies over all voltage and temperature operating ranges
Load mismatch stress with no permanent degradation or failure	8:1	-	-	VSWR	V <sub>CC</sub> = +5.0 V, P <sub>IN</sub> = +5 dBm Applies over full operating temperature range

PERFORMANCE DATA

**Figure 3: PAE vs. Frequency**  
**P<sub>OUT</sub> = +29 dBm, High Bias Mode**  
 (T<sub>C</sub> = +25 °C, V<sub>CC</sub> = +3.4 V, V<sub>REF</sub> = +2.9 V, V<sub>MODE</sub> = 0 V)

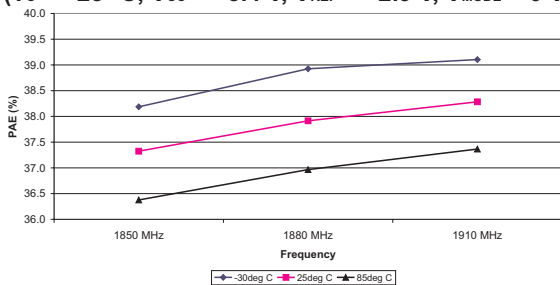

**Figure 4: ACP1 vs. Frequency**  
**P<sub>OUT</sub> = +29 dBm, High Bias Mode**  
 (T<sub>C</sub> = +25 °C, V<sub>CC</sub> = +3.4 V, V<sub>REF</sub> = +2.9 V, V<sub>MODE</sub> = 0 V)

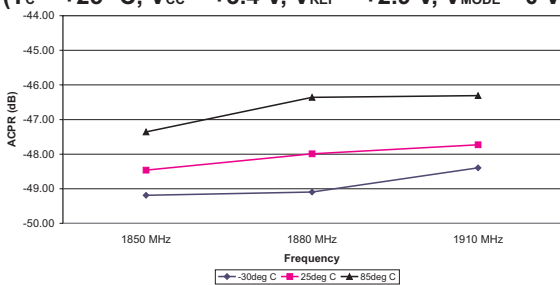

**Figure 5: ACP2 vs. Frequency**  
**P<sub>OUT</sub> = +29 dBm, High Bias Mode**  
 (T<sub>C</sub> = +25 °C, V<sub>CC</sub> = +3.4 V, V<sub>REF</sub> = +2.9 V, V<sub>MODE</sub> = 0 V)

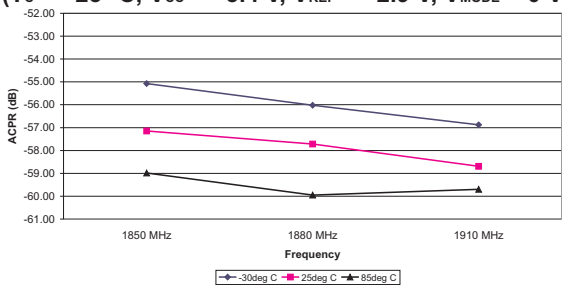

**Figure 6: PAE vs. Frequency**  
**P<sub>OUT</sub> = +16 dBm, Low Bias Mode**  
 (T<sub>C</sub> = +25 °C, V<sub>CC</sub> = +3.4 V, V<sub>REF</sub> = +2.9 V, V<sub>MODE</sub> = +2.9 V)

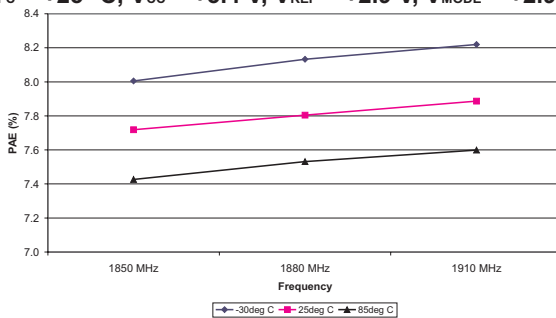

**Figure 7: ACP1 vs. Frequency**  
**P<sub>OUT</sub> = +16 dBm, Low Bias Mode**  
 (T<sub>C</sub> = +25 °C, V<sub>CC</sub> = +3.4 V, V<sub>REF</sub> = +2.9 V, V<sub>MODE</sub> = +2.9 V)

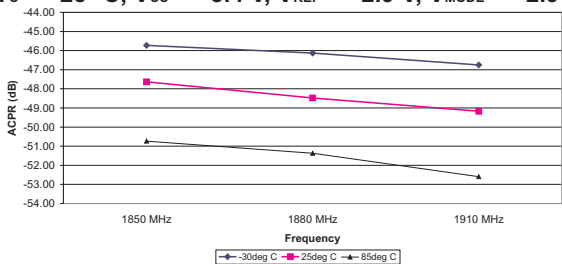

**Figure 8: ACP2 vs. Frequency**  
**P<sub>OUT</sub> = +16 dBm, Low Bias Mode**  
 (T<sub>C</sub> = +25 °C, V<sub>CC</sub> = +3.4 V, V<sub>REF</sub> = +2.9 V, V<sub>MODE</sub> = +2.9 V)

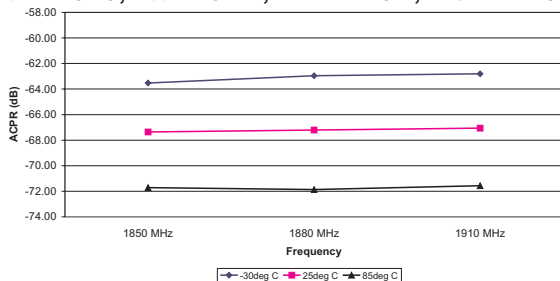

PERFORMANCE DATA

Figure 9: Input Power vs. Output Power and Frequency  
 (T<sub>C</sub> = +25 °C, V<sub>CC</sub> = +3.4 V, V<sub>REF</sub> = +2.9 V)

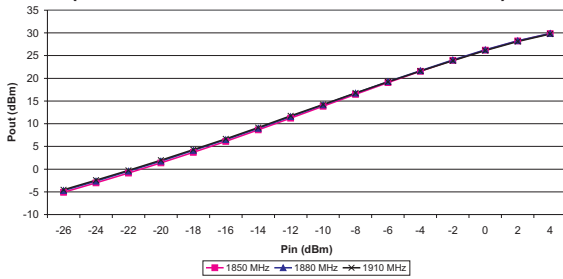

Figure 10: ACP1 & ACP2 vs. Output Power and Frequency  
 (T<sub>C</sub> = +25 °C, V<sub>CC</sub> = +3.4 V, V<sub>REF</sub> = +2.9 V)

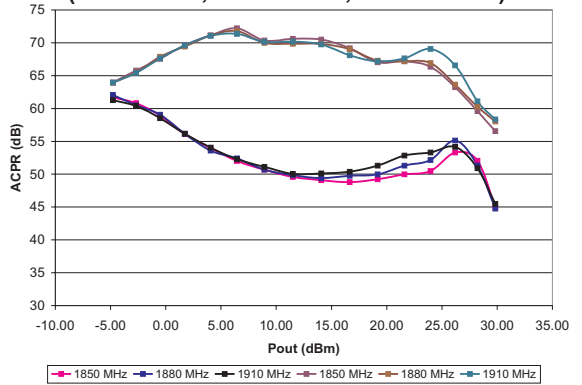
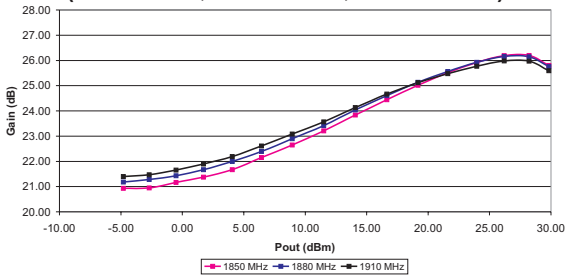

Figure 11: Large Signal Gain vs. Output Power and Frequency  
 (T<sub>C</sub> = +25 °C, V<sub>CC</sub> = +3.4 V, V<sub>REF</sub> = +2.9 V)



## APPLICATION INFORMATION

To ensure proper performance, refer to all related Application Notes on the ANADIGICS web site: <http://www.anadigics.com>

### Shutdown Mode

The power amplifier may be placed in a shutdown mode by applying logic low levels (see Operating Ranges table) to both the  $V_{REF}$  and  $V_{MODE}$  voltages.

### Bias Modes

The power amplifier may be placed in either a Low Bias mode or a High Bias mode by applying the appropriate logic level (see Operating Ranges table) to the  $V_{MODE}$  voltage. The Bias Control table lists the recommended modes of operation for various applications.

**Table 5: Bias Control**

APPLICATION	$P_{OUT}$ LEVELS	BIAS MODE	$V_{REF}$	$V_{MODE}$
CDMA - low power	$\leq +16\text{dBm}$	Low	+2.9 V	+2.9 V
CDMA - high power	$> +16\text{ dBm}$	High	+2.9 V	0 V
Shutdown	-	Shutdown	0 V	0 V

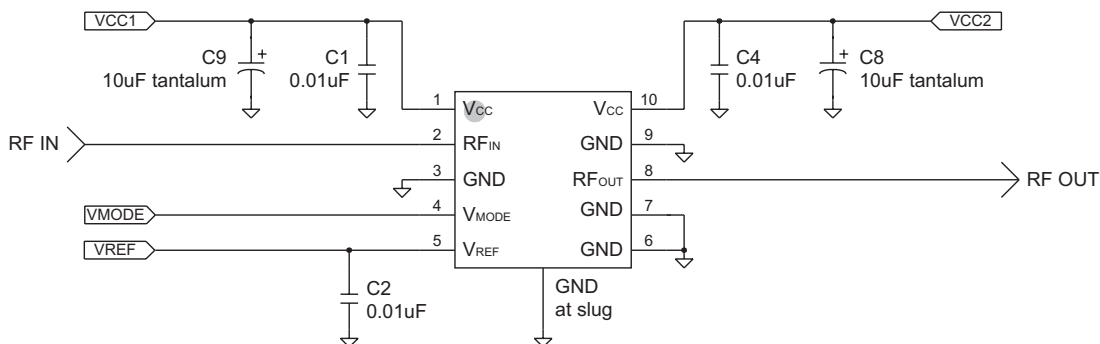

**Figure 12: Application Circuit Schematic**

PACKAGE OUTLINE

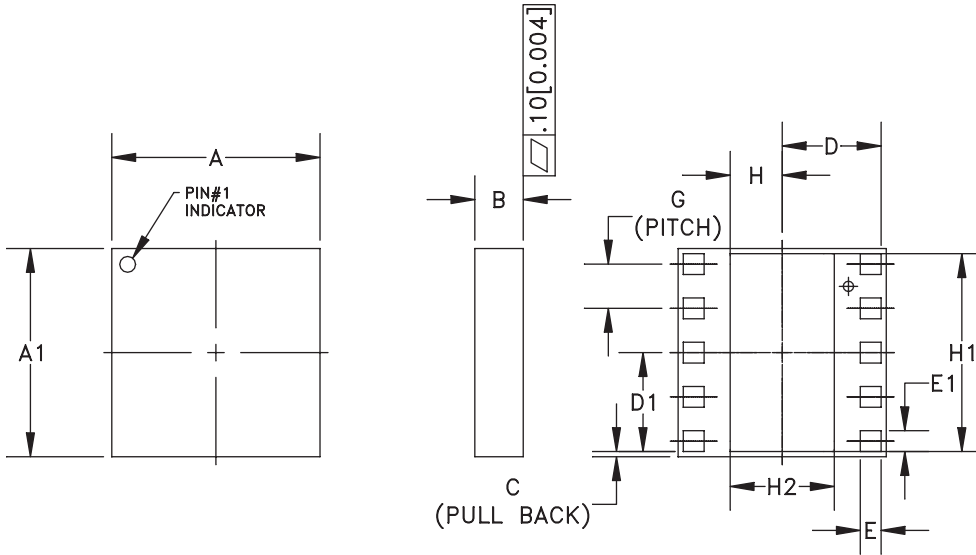

S <sub>MD</sub>	MILLIMETERS			INCHES			NOTE
	MIN.	NOM.	MAX.	MIN.	NOM.	MAX.	
A	3.88	4.00	4.12	0.152	0.157	0.162	-
A1	3.88	4.00	4.12	0.152	0.157	0.162	-
B	1.26	1.41	1.56	0.049	0.055	0.061	-
C	-	0.10	-	-	0.004	-	-
D	-	1.90	-	-	0.075	-	-
D1	-	1.90	-	-	0.075	-	-
E	0.35	0.40	0.45	0.013	0.015	0.017	-
E1	0.35	0.40	0.45	0.013	0.015	0.017	-
G	0.85 BSC			0.033 BSC			-
H	-	1.00	-	-	0.039	-	-
H1	-	3.80	-	-	0.149	-	-
H2	-	2.00	-	-	0.078	-	-

NOTES:

1. CONTROLLING DIMENSIONS: MILLIMETERS
2. UNLESS SPECIFIED TOLERANCE=±0.076[0.003].

Figure 13: M7 Package Outline - 10 Pin 4mm x 4mm Surface Mount Module

TOP BRAND



NOTES:

1. ANADIGICS LOGO SIZE: X=0.040±0.010 Y=0.048±0.010
2. PART # AWT6131
3. YEAR AND WORK WEEK: YYWW: YY = YEAR, WW = WORK WEEK
4. LOT - WAFER I.D.: LLLLL - SS = WAFER/LOT I.D.
5. PIN 1 INDICATOR: MOLD NOTCH -or- INK DOT
6. BOM # & REV. BBB
7. COUNTRY CODE: CCCCC
8. TYPE : ELITE  
SIZE : AS LARGE AS POSSIBLE  
WHITE or SILVER

Figure 14: Branding Specification



COMPONENT PACKAGING

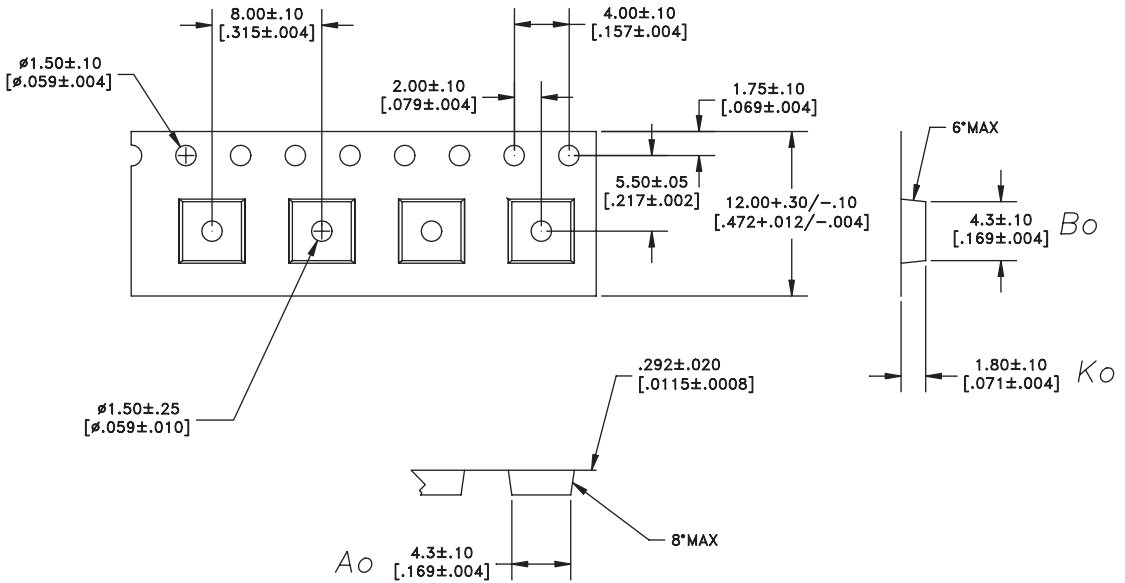

DIMENSIONS ARE IN MILLIMETERS [INCHES]  
STANDARD TOLERANCES

Figure 15: Tape & Reel Packaging

Table 6: Tape & Reel Dimensions

PACKAGE TYPE	TAPE WIDTH	POCKET PITCH	REEL CAPACITY	MAX REEL DIA
4mm X 4mm	12mm	8mm	2500	13"

**AWT6131**

**NOTES**

NOTES

**ORDERING INFORMATION**

ORDER NUMBER	TEMPERATURE RANGE	PACKAGE DESCRIPTION	COMPONENT PACKAGING
AWT6131M7P8	-30 °C to +110 °C	10 Pin 4mm x 4mm Surface Mount Module	Tape and Reel, 2500 pieces per Reel



**ANADIGICS, Inc.**

141 Mount Bethel Road  
Warren, New Jersey 07059, U.S.A.  
Tel: +1 (908) 668-5000  
Fax: +1 (908) 668-5132

URL: <http://www.anadigics.com>  
E-mail: [Mktg@anadigics.com](mailto:Mktg@anadigics.com)

**IMPORTANT NOTICE**

ANADIGICS, Inc. reserves the right to make changes to its products or to discontinue any product at any time without notice. The product specifications contained in Advanced Product Information sheets and Preliminary Data Sheets are subject to change prior to a product's formal introduction. Information in Data Sheets have been carefully checked and are assumed to be reliable; however, ANADIGICS assumes no responsibilities for inaccuracies. ANADIGICS strongly urges customers to verify that the information they are using is current before placing orders.

**WARNING**

ANADIGICS products are not intended for use in life support appliances, devices or systems. Use of an ANADIGICS product in any such application without written consent is prohibited.