

AZ10ELT20 AZ100ELT20

CMOS/TTL to Differential PECL Translator

FEATURES

- 0.5ns Typical Propagation Delay
- Differential PECL Outputs
- Flow Through Pinouts
- Operating Range of +3.0V to +5.5V
- Direct Replacement for ON Semi MC100ELT20 & Micrel SY89329V
- Available in 2x2 and 3x3 mm MLP Packages

PACKAGE AVAILABILITY

| PACKAGE | PART NUMBER | MARKING | NOTES |
|--------------------------------------------------------|-----------------|----------------------------|-------|
| MLP 8 (2x2x0.75) | AZ100ELT20N | T0 <Date Code> | 1,2 |
| MLP 8 (2x2x0.75) RoHS Compliant / Lead (Pb) Free | AZ100ELT20N+ | T0+ <Date Code> | 1,2 |
| MLP 16 (3x3) | AZ10/100ELT20L | AZM T20 <Date Code> | 1,2 |
| MLP 16 (3x3) Lead-Free | AZ10/100ELT20L+ | AZM+ T20 <Date Code> | 1,2 |
| SOIC 8 | AZ10ELT20D | AZM10 ELT20 | 1,2,3 |
| SOIC 8 | AZ100ELT20D | AZM100 ELT20 | 1,2,3 |
| TSSOP 8 | AZ100ELT20T | AZH LT20 | 1,2,3 |
| TSSOP 8 RoHS Compliant / Lead (Pb) Free | AZ100ELT20T+ | AZH+ LT20 | 1,2,3 |
| DIE | AZ10/100ELT20XP | N/A | 4 |

- 1 Add R1 at end of part number for 7 inch (1K parts), R2 for 13 inch (2.5K parts) Tape & Reel.
- 2 Date code format: "Y" or "YY" for year followed by "WW" for week.
- 3 Date code "YWW" or "YYWW" on underside of part.
- 4 Waffle Pack.

DESCRIPTION

The AZ10/100ELT20 is a CMOS/TTL to differential PECL translator. It operates with a single power supply of +3.0 to +5.5 volts, making it ideal for both LVCMOS/LVTTL and CMOS/TTL applications. The extremely small MLP 8 2x2 mm package makes it ideal for those applications where space, performance and low power are at a premium.

When the D input is left floating, the Q output is forced HIGH, and the Q output is forced LOW.

The ELT20 is available in both PECL standards: the AZ10ELT20 is compatible with PECL 10K logic levels while the AZ100ELT20 is compatible with PECL 100K logic levels.

NOTE: Specifications in the PECL tables are valid when thermal equilibrium is established.

BLOCK DIAGRAM

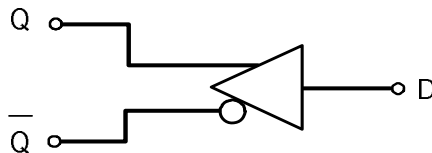

AZ10ELT20

AZ100ELT20

Absolute Maximum Ratings are those values beyond which device life may be impaired.

| Symbol | Characteristic | Value | Unit |
|------------------|--------------------------------------------------------------------------|-------------|------|
| V _{CC} | DC Supply Voltage (Referenced to GND) | 0 to +8.0 | V |
| V _{IN} | Input Voltage | 0 to +6.0 | V |
| I _{OUT} | Current Applied to Output in Low Output State — Continuous — Surge | 50 100 | mA |
| T _A | Operating Temperature Range (In Free-Air) | -40 to +85 | °C |
| T _{STG} | Storage Temperature Range | -65 to +150 | °C |

TTL/CMOS INPUT DC CHARACTERISTICS (GND = 0.0V, V_{CC} = +3.0V to +5.5V)

| Symbol | Characteristic | Min | Typ | Max | Unit | Condition |
|------------------|---------------------------|-----|-----|------|------|-----------------------------------|
| I _{IH} | Input HIGH Current | | | 15 | μA | V _{IN} = 2.7V |
| I _{IHH} | Input HIGH Current | | | 20 | μA | V _{IN} = V _{CC} |
| I _{IL} | Input LOW Current | | | -0.1 | mA | V _{IN} = 0.5V |
| V _{IK} | Input Clamp Diode Voltage | | | -1.2 | V | I _{IN} = -18mA |
| V _{IH} | Input HIGH Voltage | 2.0 | | | V | |
| V _{IL} | Input LOW Voltage | | | 0.8 | V | |

10K LVPECL DC Characteristics (GND = 0.0V, V_{CC} = +3.3V)

| Symbol | Characteristic | -40°C | | | 0°C | | | 25°C | | | 85°C | | | Unit |
|-----------------|------------------------------------|-------|-----|------|------|-----|------|------|-----|------|------|-----|------|------|
| | | Min | Typ | Max | Min | Typ | Max | Min | Typ | Max | Min | Typ | Max | |
| V _{OH} | Output HIGH Voltage ^{1,2} | 2220 | | 2410 | 2280 | | 2460 | 2320 | | 2490 | 2390 | | 2580 | mV |
| V _{OL} | Output LOW Voltage ^{1,2} | 1350 | | 1650 | 1350 | | 1670 | 1350 | | 1670 | 1350 | | 1705 | mV |
| I _{CC} | Power Supply Current ³ | | | 16 | | | 16 | | | 16 | | | 16 | mA |

- Output parameters vary 1:1 with V_{CC}.
- Each output is terminated through a 50Ω resistor to V_{CC} - 2V.
- I_{CC} measurements must be done with outputs open.

10K PECL DC Characteristics (GND = 0.0V, V_{CC} = +5.0V)

| Symbol | Characteristic | -40°C | | | 0°C | | | 25°C | | | 85°C | | | Unit |
|-----------------|------------------------------------|-------|-----|------|------|-----|------|------|-----|------|------|-----|------|------|
| | | Min | Typ | Max | Min | Typ | Max | Min | Typ | Max | Min | Typ | Max | |
| V _{OH} | Output HIGH Voltage ^{1,2} | 3920 | | 4110 | 3980 | | 4160 | 4020 | | 4190 | 4090 | | 4280 | mV |
| V _{OL} | Output LOW Voltage ^{1,2} | 3050 | | 3350 | 3050 | | 3370 | 3050 | | 3370 | 3050 | | 3405 | mV |
| I _{CC} | Power Supply Current ³ | | | 16 | | | 16 | | | 16 | | | 16 | mA |

- Output parameters vary 1:1 with V_{CC}.
- Each output is terminated through a 50Ω resistor to V_{CC} - 2V.
- I_{CC} measurements must be done with outputs open.

100K LVPECL DC Characteristics (GND = 0.0V, V_{CC} = +3.3V)

| Symbol | Characteristic | -40°C | | | 0°C | | | 25°C | | | 85°C | | | Unit |
|-----------------|------------------------------------|-------|-----|------|------|-----|------|------|-----|------|------|-----|------|------|
| | | Min | Typ | Max | Min | Typ | Max | Min | Typ | Max | Min | Typ | Max | |
| V _{OH} | Output HIGH Voltage ^{1,2} | 2220 | | 2420 | 2275 | | 2420 | 2275 | | 2420 | 2275 | | 2420 | mV |
| V _{OL} | Output LOW Voltage ^{1,2} | 1400 | | 1750 | 1400 | | 1680 | 1400 | | 1680 | 1400 | | 1680 | mV |
| I _{CC} | Power Supply Current ³ | | | 16 | | | 16 | | | 16 | | | 16 | mA |

- Output parameters vary 1:1 with V_{CC}.
- Each output is terminated through a 50Ω resistor to V_{CC} - 2V.
- I_{CC} measurements must be done with outputs open.

100K PECL DC Characteristics (GND = 0.0V, V_{CC} = +5.0V)

| Symbol | Characteristic | -40°C | | | 0°C | | | 25°C | | | 85°C | | | Unit |
|-----------------|------------------------------------|-------|-----|------|------|-----|------|------|-----|------|------|-----|------|------|
| | | Min | Typ | Max | Min | Typ | Max | Min | Typ | Max | Min | Typ | Max | |
| V _{OH} | Output HIGH Voltage ^{1,2} | 3920 | | 4120 | 3975 | | 4120 | 3975 | | 4120 | 3975 | | 4120 | mV |
| V _{OL} | Output LOW Voltage ^{1,2} | 3100 | | 3450 | 3100 | | 3380 | 3100 | | 3380 | 3100 | | 3380 | mV |
| I _{CC} | Power Supply Current ³ | | | 16 | | | 16 | | | 16 | | | 16 | mA |

- Output parameters vary 1:1 with V_{CC}.
- Each output is terminated through a 50Ω resistor to V_{CC} - 2V.
- I_{CC} measurements must be done with outputs open.

AZ10ELT20

AZ100ELT20

AC CHARACTERISTICS (GND = 0.0V, V_{CC} = +3.0V to +5.5V)

| Symbol | Characteristic | -40°C | | 0°C | | 25°C | | | 85°C | | Unit | Condition |
|------------------------------------|--------------------------------|-------|-----|-----|-----|------|-----|-----|------|-----|------|-----------|
| | | Min | Max | Min | Max | Min | Typ | Max | Min | Max | | |
| t _{PLH} /t _{PHL} | Propagation Delay ¹ | 100 | 600 | 100 | 600 | 100 | | 600 | 100 | 600 | ps | |
| t _r /t _f | Output Rise/Fall Time | 200 | 500 | 200 | 500 | 200 | | 500 | 200 | 500 | ps | 20-80% |
| f _{MAX} | Maximum Frequency ² | 800 | | 800 | | 800 | | | 800 | | MHz | |

1. Propagation delay is measured from +1.5V on the input to 50% of the PECL output swing. Input rise/fall times are < 1ns/V.
2. Output at -3 dB.

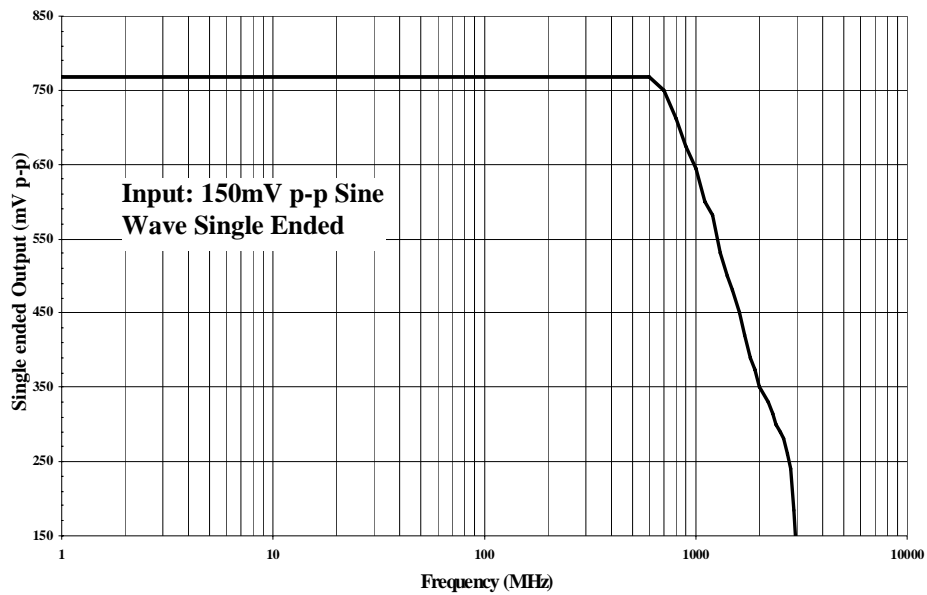

Large Signal Bandwidth

AZ10ELT20
AZ100ELT20

PIN DESCRIPTION

| PIN | FUNCTION |
|-----------------|-------------------------------------------|
| Q, \bar{Q} | Differential PECL Outputs |
| D | TTL/CMOS Input |
| GND | Ground |
| V _{CC} | Positive Supply |
| NC | No Connect, Leave Open Except as Noted |
| 10K | 10K/100K Mode Select |

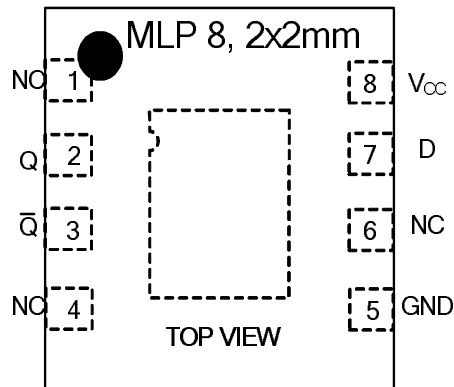

MLP 16 Package and DIE: 10K/100K Selection

Connect pin/pad 10K to GND to select 10K operation. Float (NC) pin/pad 10K to select 100K operation. GND connection must be less than 1Ω.

Pin 8 of the MLP 16 package may be connected to pin 7 (GND) with no effect on the circuit.

Leave Center Botom Pad open or connect to GND.

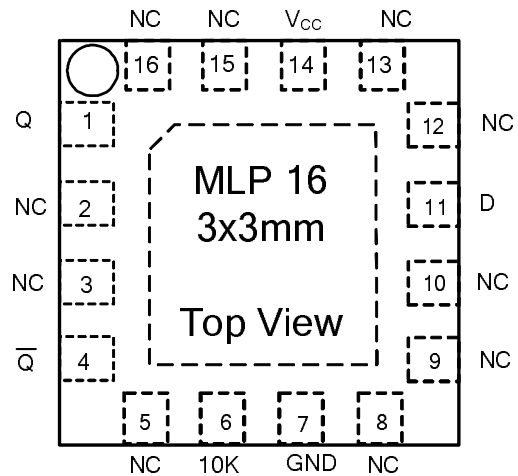
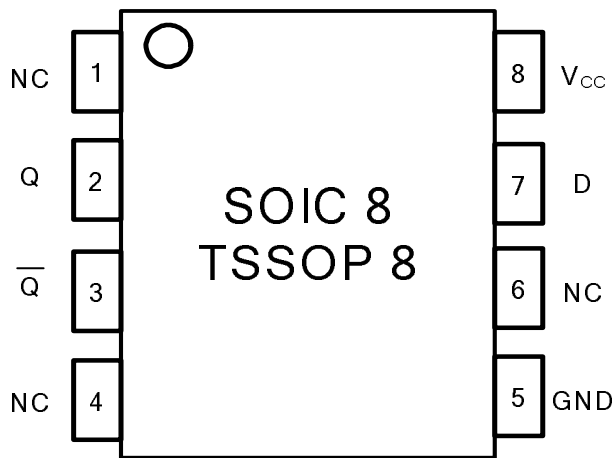

Leave Center Bottom Pad open or connect to GND.

DIE PAD COORDINATES

AZ10/100ELT20 DIE:

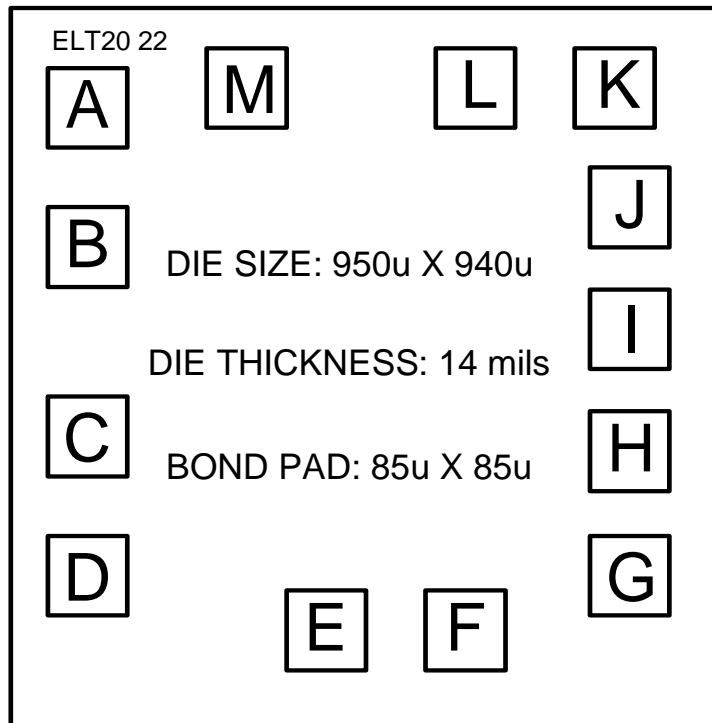

**Note: Other die thicknesses available. Contact factory for further information.
The die backside may be left open or connected to GND.**

PAD CENTER COORDINATES

| NAME | PAD DESIGNATION | X(Microns) | Y(Microns) |
|------|-----------------|------------|------------|
| A | NC | -342.5 | 312.5 |
| B | NC | -342.5 | 144.5 |
| C | D | -342.5 | -87.0 |
| D | NC | -342.5 | -255.0 |
| E | V _{CC} | -33.5 | -312.5 |
| F | V _{CC} | 126.5 | -312.5 |
| G | Q | 312.5 | -248.5 |
| H | Q | 312.5 | -98.5 |
| I | NC | 312.5 | 51.5 |
| J | NC | 312.5 | 201.5 |
| K | NC | 302.5 | 342.5 |
| L | 10K | 142.5 | 342.5 |
| M | GND | -140.5 | 342.5 |

NC = No connect, leave open.

AZ10ELT20
AZ100ELT20

PACKAGE DIAGRAM
MLP 8 2x2mm

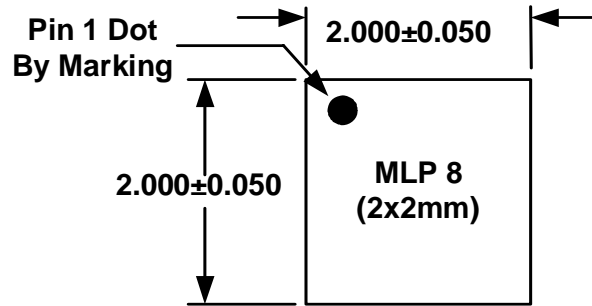

TOP VIEW

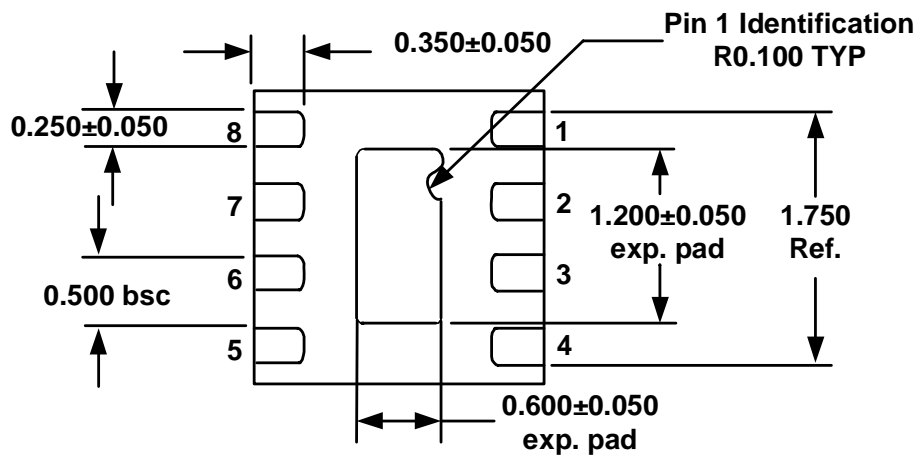

BOTTOM VIEW

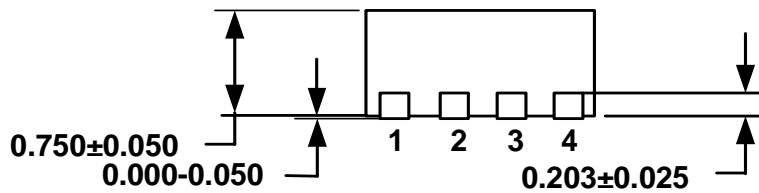

SIDE VIEW

Note: All dimensions are in mm

**PACKAGE DIAGRAM
SOIC 8**

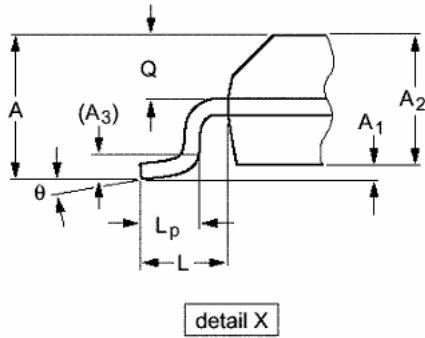
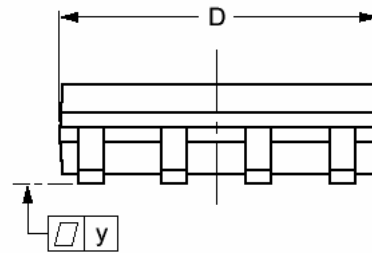
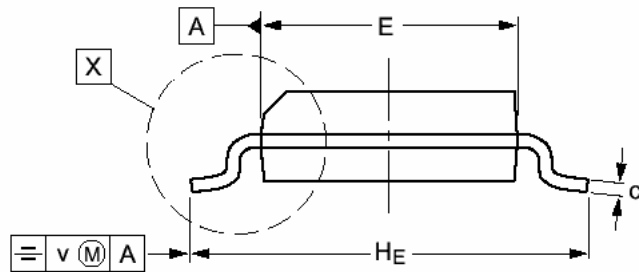
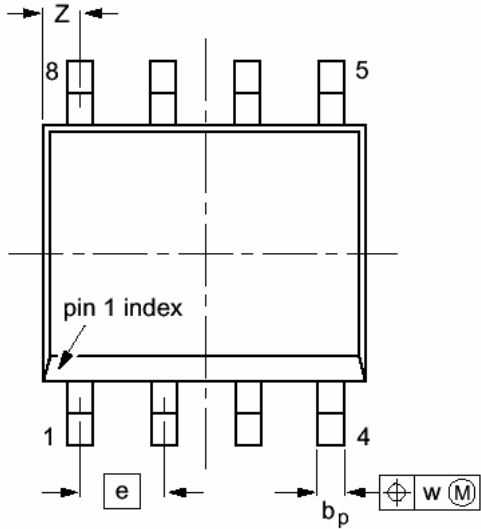

| DIM | MILLIMETERS | | INCHES | |
|----------------|-------------|------|--------|--------|
| | MIN | MAX | MIN | MAX |
| A | 1.35 | 1.75 | .053 | 0.069 |
| A ₁ | 0.10 | 0.25 | 0.004 | 0.010 |
| A ₂ | 1.28 | 1.57 | 0.050 | 0.062 |
| A ₃ | 0.25 | | 0.01 | |
| b _p | 0.36 | 0.49 | 0.014 | 0.019 |
| c | 0.19 | 0.25 | 0.0075 | 0.0100 |
| D | 4.80 | 5.00 | 0.19 | 0.20 |
| E | 3.80 | 4.00 | 0.15 | 0.16 |
| e | 1.27 | | 0.050 | |
| H _E | 5.80 | 6.20 | 0.228 | 0.244 |
| L | 1.05 | | 0.041 | |
| L _p | 0.40 | 1.27 | 0.016 | 0.050 |
| Q | 0.60 | 0.70 | 0.024 | 0.028 |
| v | 0.25 | | 0.01 | |
| w | 0.25 | | 0.01 | |
| y | 0.10 | | 0.004 | |
| Z | 0.30 | 0.70 | 0.012 | 0.028 |
| θ | 0° | 8° | 0° | 8° |

NOTES:

1. DIMENSIONS D AND E DO NOT INCLUDE MOLD PROTRUSION.
2. MAXIMUM MOLD PROTRUSION FOR D IS 0.15mm.
3. MAXIMUM MOLD PROTRUSION FOR E IS 0.25mm.

**PACKAGE DIAGRAM
TSSOP 8**

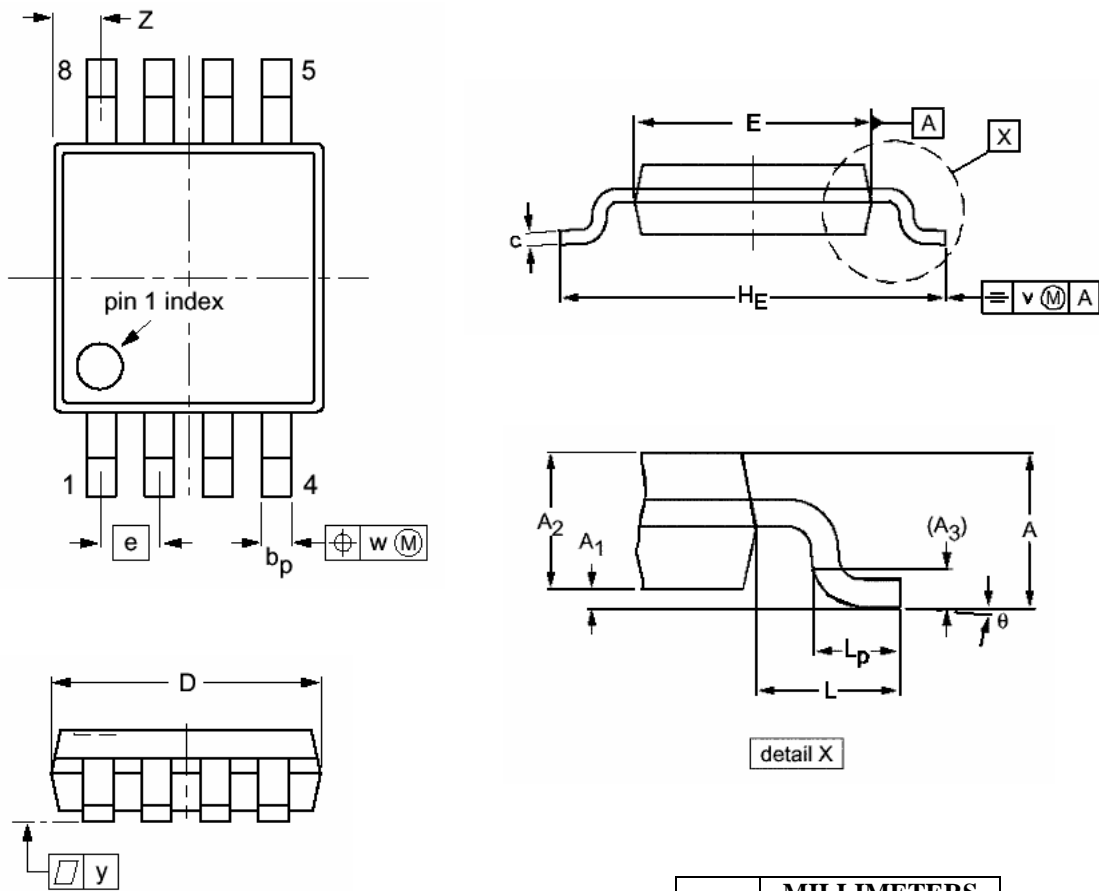

- NOTES:
1. DIMENSIONS D AND E DO NOT INCLUDE MOLD PROTRUSION.
 2. MAXIMUM MOLD PROTRUSION FOR D IS 0.15mm.
 3. MAXIMUM MOLD PROTRUSION FOR E IS 0.25mm.

| DIM | MILLIMETERS | |
|----------------|-------------|------|
| | MIN | MAX |
| A | | 1.10 |
| A ₁ | 0.05 | 0.15 |
| A ₂ | 0.75 | 0.95 |
| A ₃ | 0.25 | |
| b _p | 0.22 | 0.40 |
| c | 0.13 | 0.23 |
| D | 2.90 | 3.10 |
| E | 2.90 | 3.10 |
| e | 0.65 | |
| H _E | 4.75 | 5.05 |
| L | 0.95 | |
| L _p | 0.40 | 0.70 |
| v | 0.10 | |
| w | 0.08 | |
| y | 0.10 | |
| Z | 0.38 | 0.64 |
| θ | 0° | 6° |

**PACKAGE DIAGRAM
MLP 16 3x3mm**

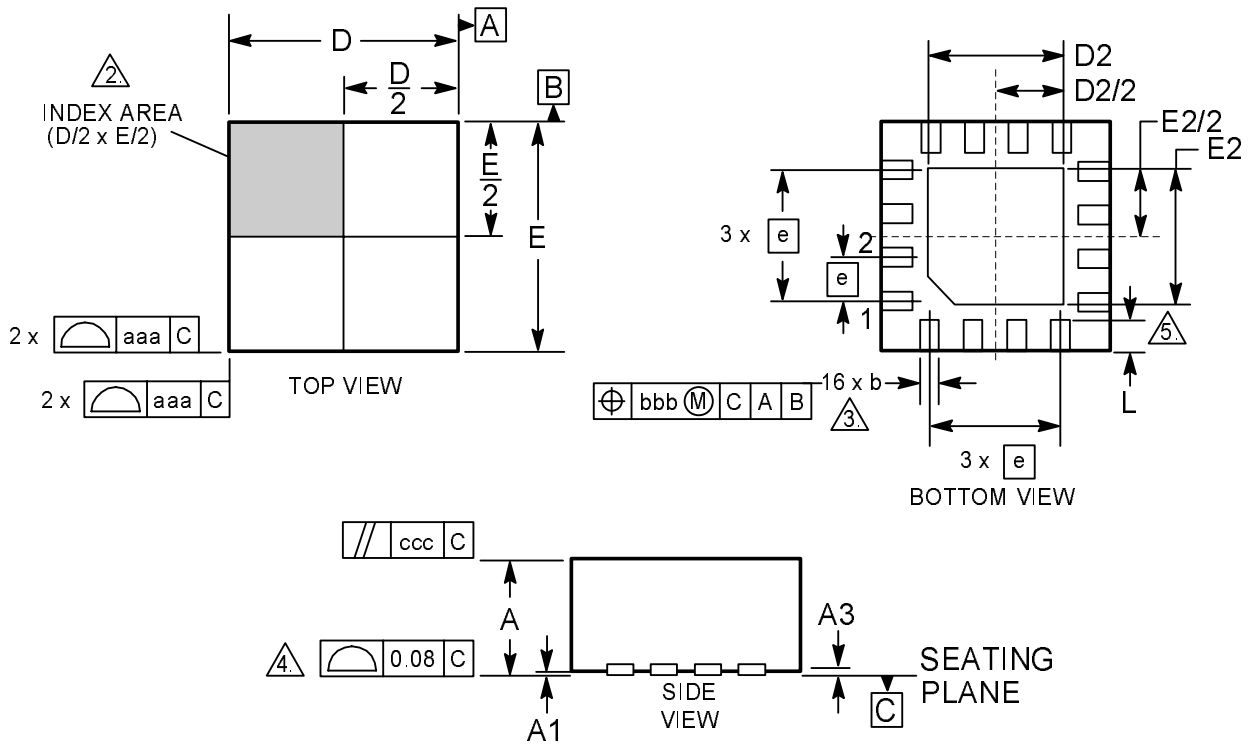

NOTES:

1. DIMENSIONING AND TOLERANCING CONFORM TO ASME T14-1994.
2. THE TERMINAL #1 AND PAD NUMBERING CONVENTION SHALL CONFORM TO JESD 95-1 SPP-012.
3. DIMENSION b APPLIES TO METALLIZED PAD AND IS MEASURED BETWEEN 0.25 AND 0.30 mm FROM PAD TIP.
4. COPLANARITY APPLIES TO THE EXPOSED PADS AS WELL AS THE TERMINALS.
5. INSIDE CORNERS OF METALLIZED PAD MAY BE SQUARE OR ROUNDED

| DIM | MILLIMETERS | |
|-----|-------------|------|
| | MIN | MAX |
| A | 0.80 | 1.00 |
| A1 | 0.00 | 0.05 |
| A3 | 0.25 REF | |
| b | 0.18 | 0.30 |
| D | 2.90 | 3.10 |
| D2 | 0.25 | 1.95 |
| E | 2.90 | 3.10 |
| E2 | 0.25 | 1.95 |
| e | 0.50 BSC | |
| L | 0.30 | 0.50 |
| aaa | 0.25 | |
| bbb | 0.10 | |
| ccc | 0.10 | |

AZ10ELT20
AZ100ELT20

Arizona Microtek, Inc. reserves the right to change circuitry and specifications at any time without prior notice. Arizona Microtek, Inc. makes no warranty, representation or guarantee regarding the suitability of its products for any particular purpose, nor does Arizona Microtek, Inc. assume any liability arising out of the application or use of any product or circuit and specifically disclaims any and all liability, including without limitation special, consequential or incidental damages. Arizona Microtek, Inc. does not convey any license rights nor the rights of others. Arizona Microtek, Inc. products are not designed, intended or authorized for use as components in systems intended to support or sustain life, or for any other application in which the failure of the Arizona Microtek, Inc. product could create a situation where personal injury or death may occur. Should Buyer purchase or use Arizona Microtek, Inc. products for any such unintended or unauthorized application, Buyer shall indemnify and hold Arizona Microtek, Inc. and its officers, employees, subsidiaries, affiliates, and distributors harmless against all claims, costs, damages, and expenses, and reasonable attorney fees arising out of, directly or indirectly, any claim of personal injury or death associated with such unintended or unauthorized use, even if such claim alleges that Arizona Microtek, Inc. was negligent regarding the design or manufacture of the part.