

1.5V / 15mW dual power amplifier

BA5152F

The BA5152F is a dual-channel power amplifier designed for 1.5V headphone stereos. The circuit consists of a power supply circuit, mute circuit, bias circuit, and two amplifier circuits. To simplify assembly, the gain is fixed, so external negative-feedback components are not required.

●Applications

1.5V headphone Hi-Fi stereos

●Features

- 1) High output. $P_{OUT} = 15\text{mW}$ ($R_L = 16\Omega$).
- 2) Small "pop" noise.
- 3) Mute circuit terminal provided.
- 4) Terminals provided for radiation countermeasures.
- 5) Good ripple rejection ratio.
- 6) Few external components required.
- 7) Good low-voltage characteristics.
- 8) Built-in power switch circuit.

●Block diagram

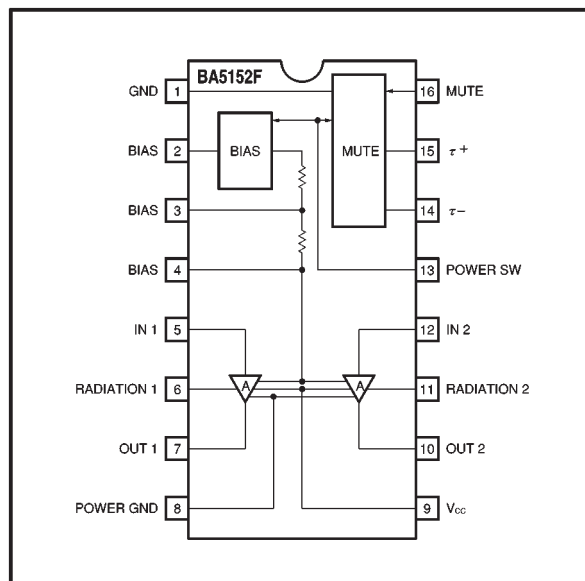

●Absolute maximum ratings ($T_a = 25^\circ\text{C}$)

Parameter	Symbol	Limits	Unit
Power supply voltage	V_{CC}	4.5	V
Power dissipation	P_d	500*	mW
Operating temperature	T_{opr}	$-25 \sim +75$	$^\circ\text{C}$
Storage temperature	T_{stg}	$-55 \sim +125$	$^\circ\text{C}$

* Reduced by 5.0mW for each increase in T_a of 1°C over 25°C (when mounted on a $50\text{mm} \times 50\text{mm} \times 1.6\text{mm}$ glass epoxy board).

● Recommended operating conditions (Ta = 25°C)

Parameter	Symbol	Min.	Typ.	Max.	Unit
Power supply voltage	V _{CC}	1.0	1.5	1.8	V

● Electrical characteristics (unless otherwise noted, Ta = 25°C, V_{CC} = 1.5V, f = 1kHz and R_L = 16Ω)

Parameter	Symbol	Min.	Typ.	Max.	Unit	Conditions	Measurement circuit
Quiescent current	I _Q	—	12	18	mA	V _{IN} =0V _{rms}	Fig.1
Closed loop voltage gain	G _{VC}	18	21	24	dB	V _{IN} =-46dBm	Fig.1
Rated output	P _{OUT}	10	15	—	mW	THD=10%	Fig.1
Total harmonic distortion	THD	—	1	3	%	P _O =2.5mW	Fig.1
Output noise voltage	V _{NO}	—	23	47	μV _{rms}	R _g =0Ω, BPF=20Hz~20kHz	Fig.1
Input resistance	R _{IN}	6.6	9.5	12.4	kΩ	—	Fig.1
Ripple rejection ratio	RR	35	45	—	dB	V _{RR} =-30dBm, f _{RR} =100Hz, R _g =0Ω	Fig.1
Standby current	I _{ST}	—	0	10	μA	13pin : OPEN	Fig.1
Channel balance	CB	—	—	2	dB	—	Fig.1
Mute level	MUTE	70	—	—	dB	V _{IN} =-20dBm, 16pin : V _{CC}	Fig.1

● Measurement circuit

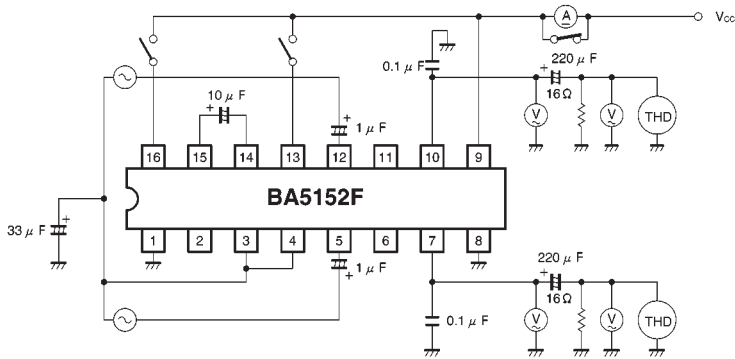

Fig. 1

● Complete application example circuit

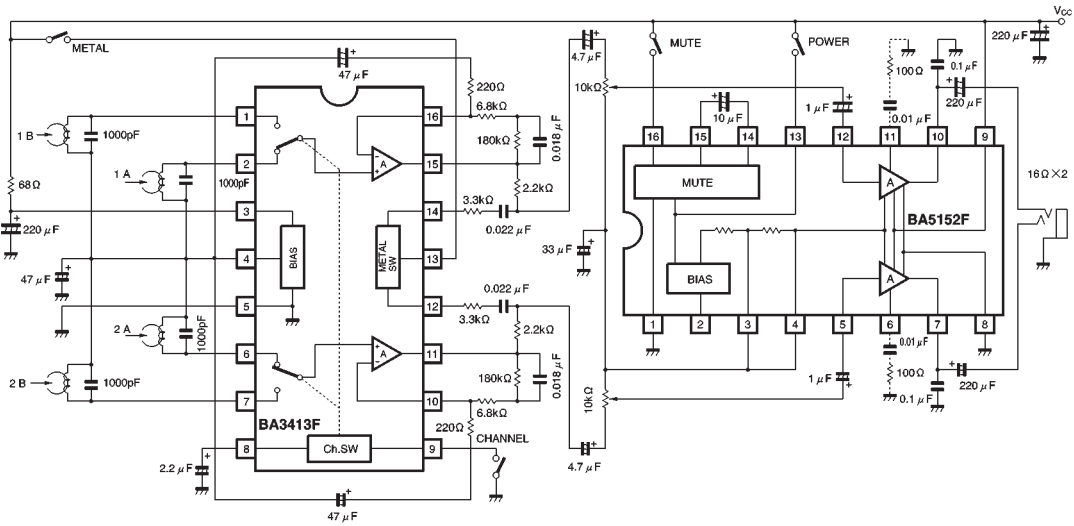

Fig. 5

● Circuit description

(1) Power supply block

The BA5152F has an internal power switch, so the V_{cc} terminal (pin 9) connects directly to the power source. Pin 13 is the power switch, and if it is left open, no bias current flows in the circuit and the IC will not operate.

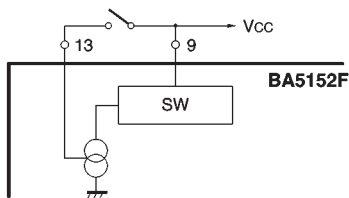

Fig. 6

(2) Mute circuit block

When pin 13 is connected to V_{cc} , the IC starts up, but the mute circuit operates to suppress a “pop” sound from being generated. The time constant of the power-on mute circuit is determined by the capacitor connected between pins 14 and 15. It is also possible to force the mute circuit to operate by connecting pin 16 to V_{cc} . There is no time constant in this case.

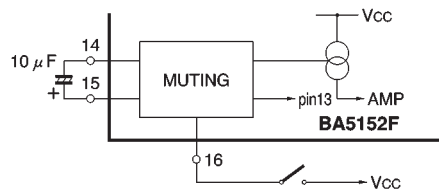

Fig. 7

(3) Bias block

The components connected to pins 2, 3, and 4 set the bias point and V_{ODC} . When pin 2 is open circuit, and $V_{CC} = 1.25V$, the output pin V_{ODC} voltage is internally set to $1/2V_{CC}$. By connecting a resistor to pin 2 and changing the voltage divider ratio, it is possible to vary V_{ODC} . Pins 3 and 4 are shorted and connected to earth via an electrolytic capacitor to generate the bias point. When a $33\mu F$ component is used, it is possible to obtain 45dB of ripple rejection. This can be improved if pins are independently grounded through capacitors.

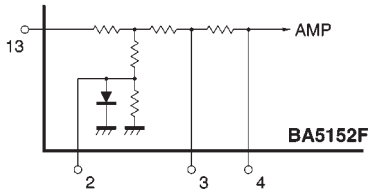

Fig. 8

(4) Amplifier block

The amplifier circuits have a fixed gain of $G_V = 21dB$. The negative-feedback circuits are on the chip, and the ground point of the negative-feedback circuit uses the bias point as its reference, so connect the input potentiometer to the bias point pins (3 and 4). Connect bypass capacitors to the output pin to prevent oscillation. When the IC is used in sets containing an AM radio, it is possible to reduce unnecessary radiation from the power amplifiers by connecting CR circuits to pins 6 and 11.

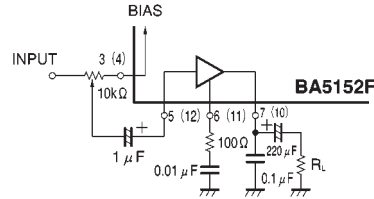

Fig. 9

● Electrical characteristics curves ($T_a = 25^\circ C$)

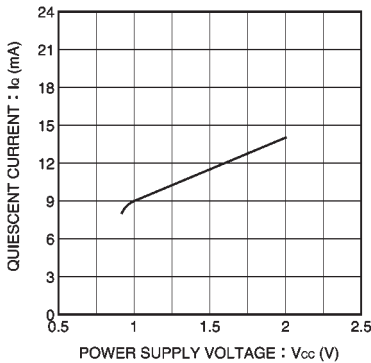

Fig. 10 Quiescent current vs. power supply voltage

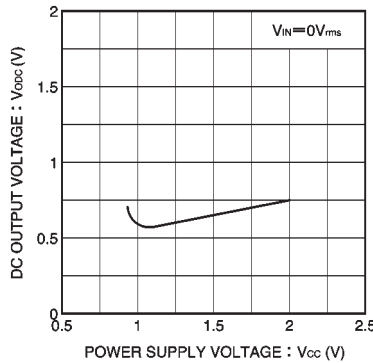

Fig. 11 DC output voltage vs. power supply voltage

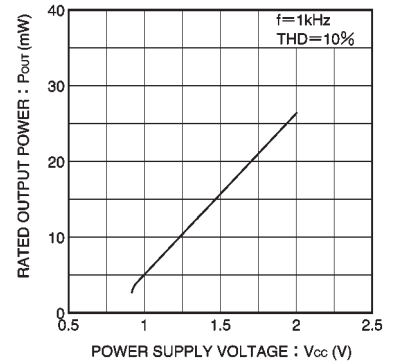

Fig. 12 Output voltage vs. power supply voltage

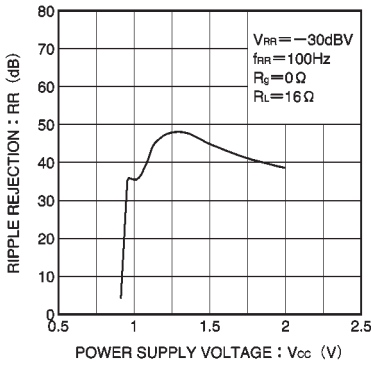

Fig. 13 Ripple rejection ratio vs. power supply voltage

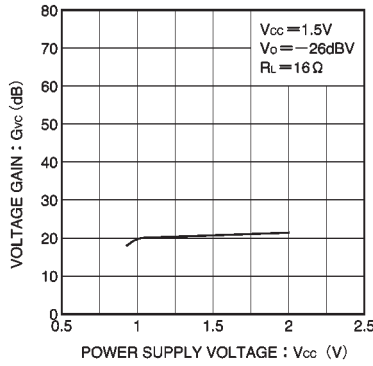

Fig. 14 Voltage gain vs. power supply voltage

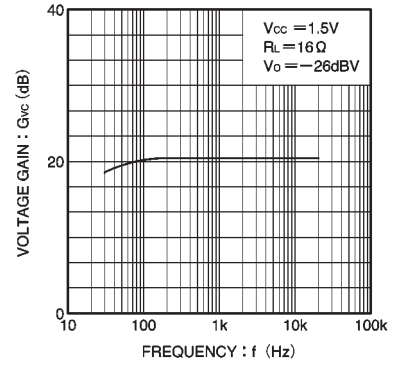

Fig. 15 Voltage gain vs. frequency

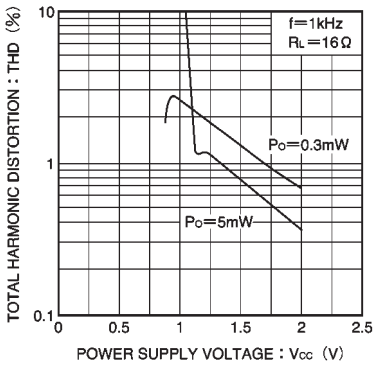

Fig. 16 Total harmonic distortion vs. power supply voltage

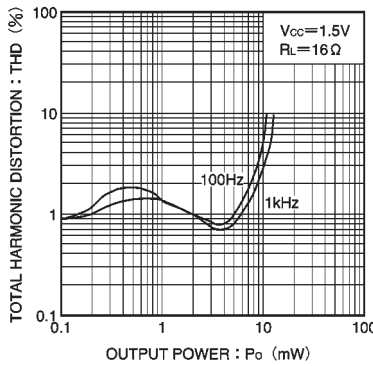

Fig. 17 Total harmonic distortion vs. output voltage

● External dimensions (Units: mm)

