

6V/330mW single-channel power amplifier

BA546

The BA546 is a monolithic power amplifier designed for use in portable radios, tape recorders and interphones. With a 6V power supply, it has a rated output of 330mW into an 8 Ω load (THD = 10%), and a maximum output of 550mW. It comes in a compact 9-pin SIP package with no heatsink fins.

●Applications

Portable radios, cassette recorders, and interphones.

●Features

- 1) High output. P_{OUT} = 330mW (V_{CC} = 6V and an 8 Ω load (THD = 10%)). See Fig. 2.
- 2) Good low voltage characteristics. Begins operating at less than 2V (see Fig. 1).
- 3) 9-pin SIP package; around the same size as a pre-amplifier.
- 4) Pin compatible with the Rohm BA526 and BA527 power ICs. Choose to suit your application.
- 5) Low current consumption (4.8mA typ.).

●Block diagram

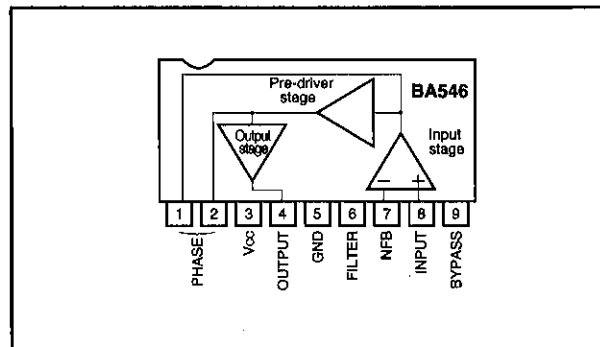

● Internal circuit diagram

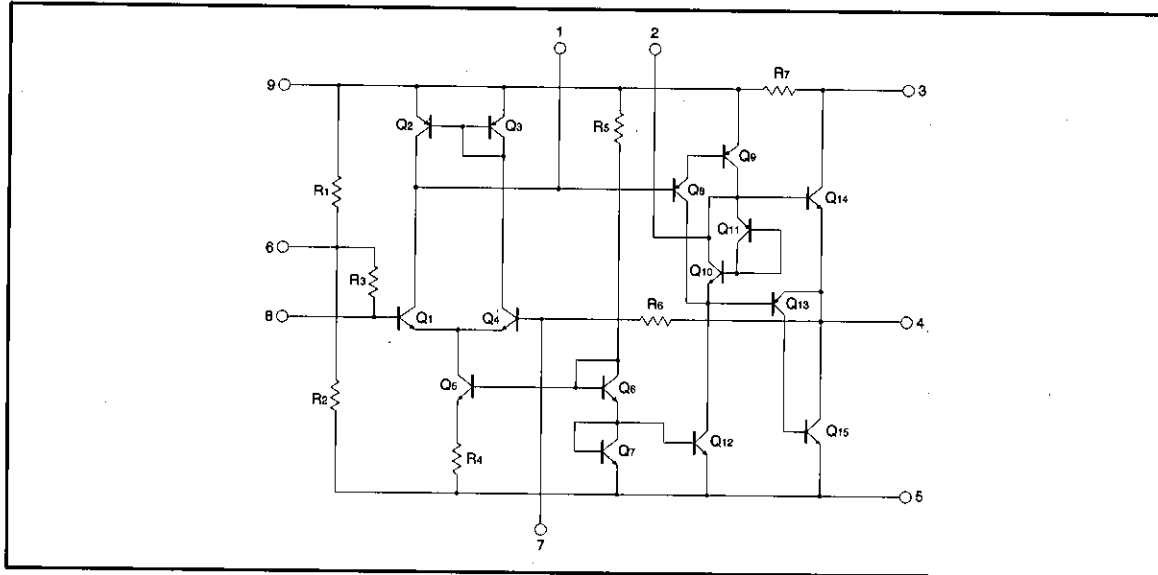

Power amplifiers

● Absolute maximum ratings (Ta = 25°C)

Parameter	Symbol	Limits	Unit
Supply voltage	V _{CC}	12	V
Power dissipation	P _d	950*	mW
Operating temperature	T _{opr}	-30~75	°C
Storage temperature	T _{stg}	-40~125	°C

* Reduced by 9.5mW for each increase in Ta of 1°C over 25°C.

● Electrical characteristics (unless otherwise specified Ta = 25°C, V_{CC} = 6V, R_L = 8 Ω and f = 1kHz)

Parameter	Symbol	Min.	Typ.	Max.	Unit	Conditions	Measurement Circuit
Quiescent circuit current	I _Q	—	4.8	7	mA	V _{IN} =0V _{rms}	Fig.10
Closed-circuit voltage gain	G _{VC}	47	50	53	dB	R _{NF} =68Ω	Fig.10
Rated output	P _{OUT}	250	330	—	mW	THD=10%	Fig.10
Total harmonic distortion	THD	—	1.1	2.5	%	P _O =100mW	Fig.10
Output noise voltage	V _{NO}	—	1.0	2.5	mV _{rms}	R _g =10kΩ	Fig.10
Input resistance	R _{IN}	—	25	—	kΩ	—	Fig.10

Low-frequency amplifiers

● Electrical characteristics curves

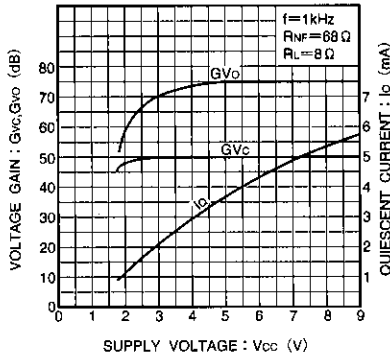

Fig. 1 Quiescent current and voltage gain vs. supply voltage

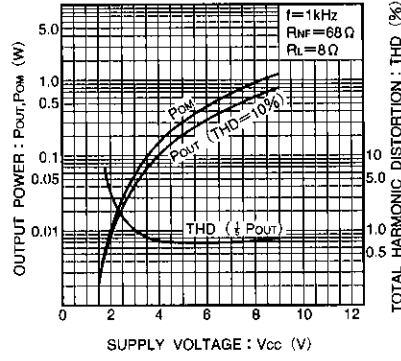

Fig. 2 Rated and max. output power and total harmonic distortion vs. supply voltage

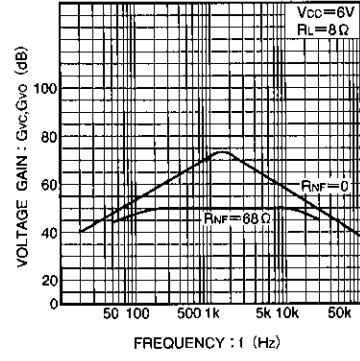

Fig. 3 Voltage gain vs. frequency

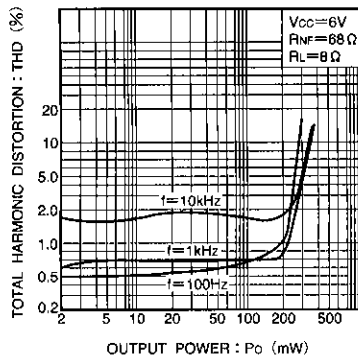

Fig. 4 Total harmonic distortion vs. output power

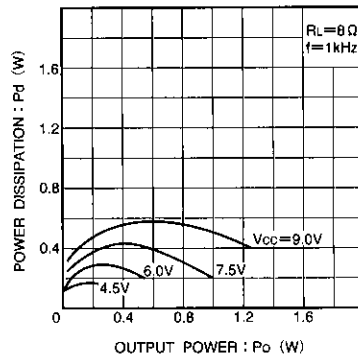

Fig. 5 Power dissipation vs. output power

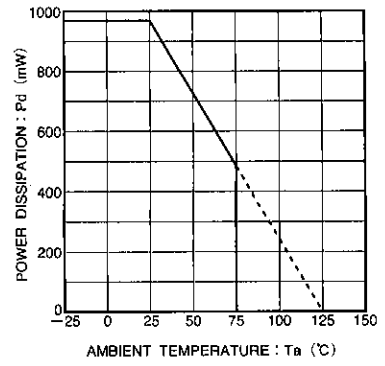

Fig. 6 Power dissipation vs. ambient temperature

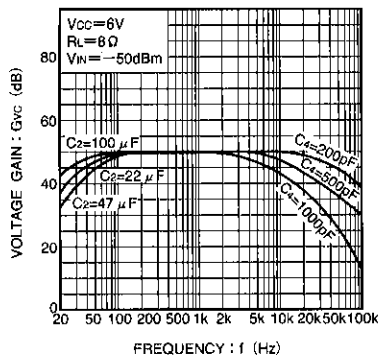

Fig. 7 Voltage gain vs. frequency

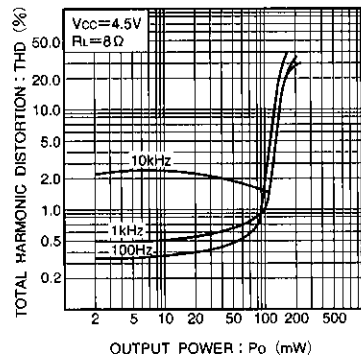

Fig. 8 Total harmonic distortion vs. output power

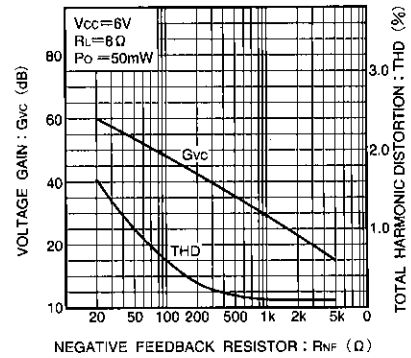

Fig. 9 Voltage gain and total harmonic distortion vs. feedback resistance

● Measurement circuit

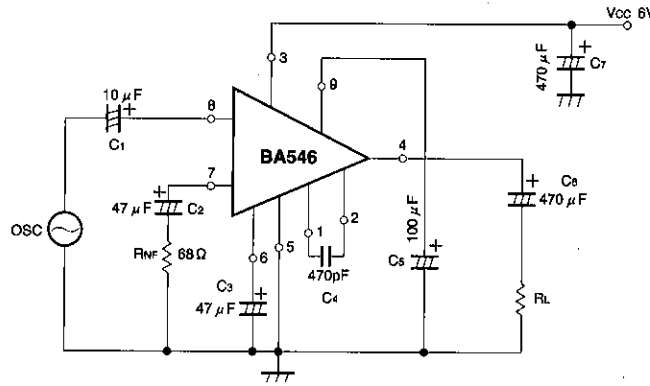

Fig. 10

● External components (see Fig. 10)

C₁ : input coupling capacitor

The recommended value is 10 μF. This capacitor and R_{IN} determine the bass cutoff frequency f_{LC1} for the input stage according to the following formula :

$$f_{LC1} = \frac{1}{2\pi C_1 R_{IN}} \text{ [Hz]}$$

If the capacitance value of C₁ is too small, the signal source reactance will increase, and cause the noise to increase and f_{LC1} will become higher. Conversely, if it is too large, the startup time after power is applied will be longer, and if the potentiometer is adjusted while the capacitor is charging, the charging current will flow through the slider current, and cause noise.

C₂ : DC cutoff resistor for the feedback circuit

The recommended value is 47 μF. This capacitor and R_{NF} determine feedback circuit bass cutoff frequency f_{LC2}. f_{LC2} is given by the following formula :

$$f_{LC2} = \frac{1}{2\pi C_2 R_{NF}} \text{ [Hz]}$$

Fig. 7 illustrates how changing C₂ varies the bass characteristics.

C₃ : ripple filter capacitor

The recommended value is 47 μF.

C₄ : Phase compensation capacitor

This capacitor determines the treble cutoff frequency f_{HC}. f_{HC} is given by the following formula :

$$f_{HC} = \frac{4000}{C_4 \text{ [pF]}} \text{ [kHz]}$$

(however, G_{VC} = 50dB)

If G_{VC} is not 50dB, f_{HC} doubles for each decrease in G_{VC} of 6dB.

Fig. 7 illustrates how changing C₄ varies the treble characteristics.

C₅ : ripple filter and pre-driver bypass capacitor

The recommended value is 100 μF. If this capacitor is made too small, the ripple rejection and power output will deteriorate.

C₆ : Output coupling capacitor

The recommended value is 470 μF.

C₇ : Power supply filter capacitor

Determine based on the amount of power supply ripple and the regulation.

Power amplifiers

Low-frequency amplifiers

●Circuit construction (See Fig. 11)

(1) Voltage amplification stage

This circuit is comprised of a differential amplifier (Q₁ and Q₄), a constant current source (Q₅), and an active load (Q₂ and Q₃). This active load is the input to the pre-driver (via Q₆ and Q₉).

(2) Pre-driver

The pre-driver is an earthed-emitter amplifier with transistors Q₆ and Q₉ forming a Darlington PNP transistor. The Q₉ collector load is the input impedance looking from the base of Q₁₄ and the constant-current load due to Q₁₂.

(3) Idling loop

The idling loop is the Q₁₃, Q₁₀, Q₁₁ and Q₁₄ loop. The V_{BE} of Q₁₃ is subtracted from the V_F of Q₁₀ and Q₁₁ and is biased by Q₁₄.

(4) Power stage

The power stage is a quasi-complementary circuit made up of a Darlington PNP transistor (Q₁₃ and Q₁₅), and an NPN transistor (Q₁₄).

(5) The AC gain is determined by the ratio between R₆ (24k Ω) and R_{NF} connected to pin 7. The formula is as follows :

$$G_{VC} \approx 20 \log \frac{24k \Omega}{R_{NF}} \text{ [dB]}$$

Variation of G_{VC} and THD with R_{NF} is shown in Fig. 9.

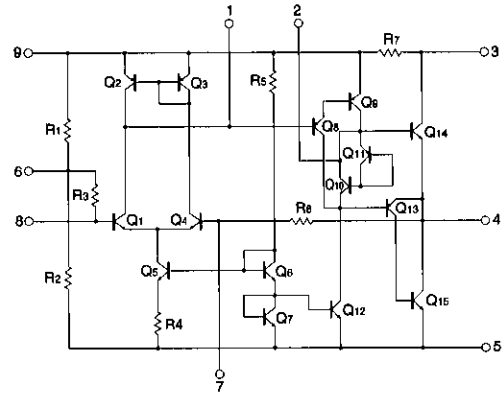

Fig. 11

●Application example

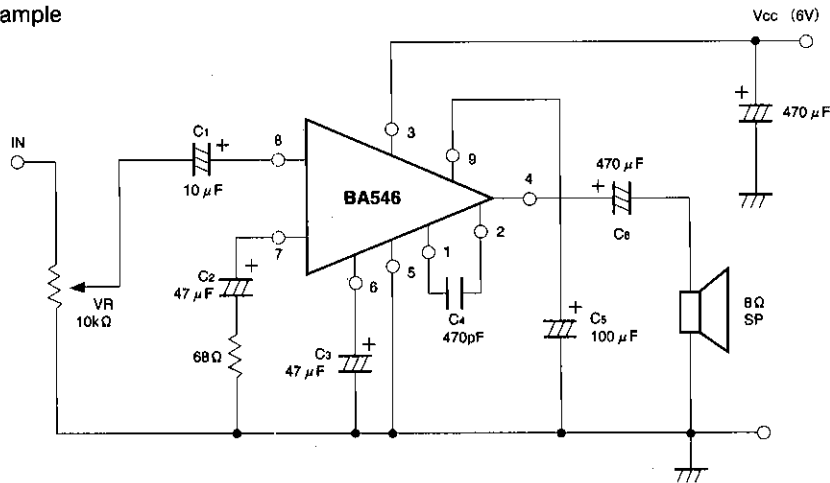
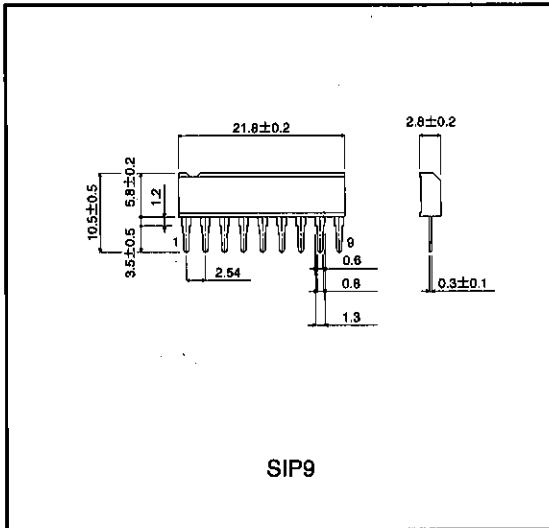

Fig. 12

The BA546 will generally be used as a power amplifier for portable cassette players and similar equipment, and will usually have a preamplifier before it, so insert the volume control between the stages. The gain of the power stage alone is determined by R_{NF}. Use Fig. 9 to choose a value for R_{NF} that gives the required gain.

When R_{NF} is 68 Ω, the standard G_{VC} is 50dB. When combining the BA546 with an ALC-equipped preamplifier as the previous stage, the control voltage for the ALC can be taken from pin 4, and the power supply for the preamplifier from pin 9.

● External dimensions (Unit: mm)



Power amplifiers

Low-frequency amplifiers