

## SMALL SIGNAL SCHOTTKY DIODE

### FEATURES AND BENEFITS

- VERY SMALL CONDUCTION LOSSES
- NEGLIGIBLE SWITCHING LOSSES
- LOW FORWARD VOLTAGE DROP
- SURFACE MOUNT DEVICE

### DESCRIPTION

Schottky barrier diodes encapsulated in a SOT-23 small SMD packages.

Double diodes with different pinning are available.

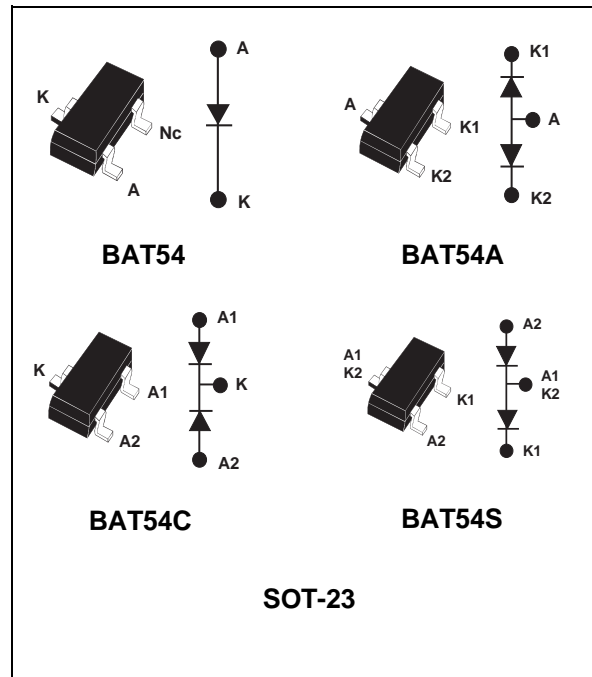

### ABSOLUTE RATINGS (limiting values)

Symbol	Parameter		Value	Unit
$V_{RRM}$	Repetitive peak reverse voltage		30	V
$I_F$	Continuous forward current		0.3	A
$I_{FSM}$	Surge non repetitive forward current	$t_p=10\text{ms}$ sinusoidal	1	A
$P_{tot}$	Power dissipation (note 1)	$T_{amb} = 25^\circ\text{C}$	250	mW
$T_{stg}$	Maximum storage temperature range		- 65 to +150	$^\circ\text{C}$
$T_j$	Maximum operating junction temperature *		150	$^\circ\text{C}$
$T_L$	Maximum temperature for soldering during 10s		260	$^\circ\text{C}$

**Note 1:** for double diodes,  $P_{tot}$  is the total dissipation of both diodes.

\* :  $\frac{dP_{tot}}{dT_j} < \frac{1}{R_{th(j-a)}}$  thermal runaway condition for a diode on its own heatsink

# BAT54, A, C, S

## THERMAL RESISTANCE

Symbol	Parameter	Value	Unit
$R_{th(j-a)}$	Junction to ambient (*)	500	$^{\circ}\text{C/W}$

(\*) Mounted on epoxy board with recommended pad layout.

## STATIC ELECTRICAL CHARACTERISTICS (per diode)

Symbol	Parameters	Tests conditions	Min.	Typ.	Max.	Unit	
$V_F^*$	Forward voltage drop	$T_j = 25^{\circ}\text{C}$	$I_F = 0.1 \text{ mA}$			240	mV
			$I_F = 1 \text{ mA}$			320	
			$I_F = 10 \text{ mA}$			400	
			$I_F = 30 \text{ mA}$			500	
			$I_F = 100 \text{ mA}$			900	
$I_R^{**}$	Reverse leakage current	$T_j = 25^{\circ}\text{C}$	$V_R = 30 \text{ V}$			1	$\mu\text{A}$
		$T_j = 100^{\circ}\text{C}$				100	

Pulse test : \*  $t_p = 380 \mu\text{s}$ ,  $\delta < 2\%$

\*\*  $t_p = 5 \text{ ms}$ ,  $\delta < 2\%$

## DYNAMIC CHARACTERISTICS ( $T_j = 25^{\circ}\text{C}$ )

Symbol	Parameters	Tests conditions	Min.	Typ.	Max.	Unit
C	Junction capacitance	$T_j = 25^{\circ}\text{C}$ $V_R = 1 \text{ V}$ $F = 1 \text{ MHz}$			10	pF
$t_{rr}$	Reverse recovery time	$I_F = 10 \text{ mA}$ $I_R = 10 \text{ mA}$ $T_j = 25^{\circ}\text{C}$ $I_{rr} = 1 \text{ mA}$ $R_L = 100 \Omega$			5	ns

**Fig.1** : Average forward power dissipation versus average forward current.

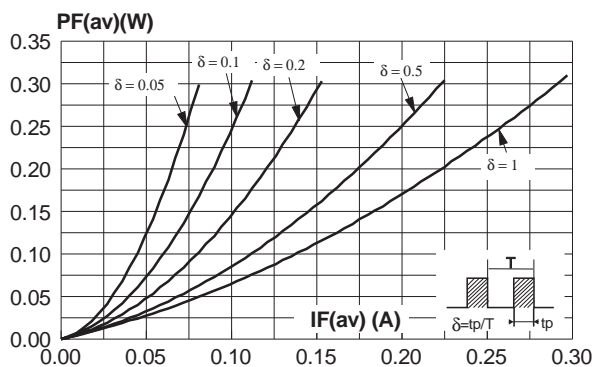

**Fig.2** : Average forward current versus ambient temperature ( $\delta = 1$ ).

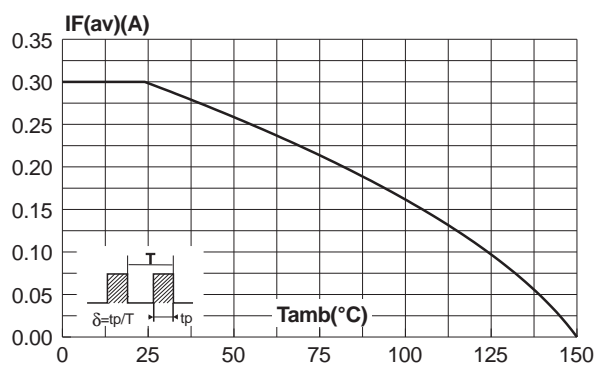

**Fig.3** : Non repetitive surge peak forward current versus overload duration (maximum values).

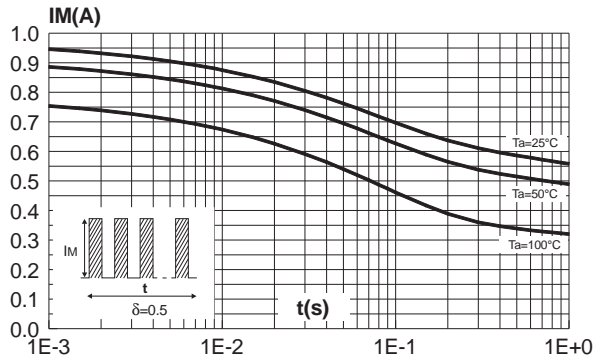

**Fig.4** : Relative variation of thermal impedance junction to ambient versus pulse duration (alumine substrate 10mm x 8mm x 0.5mm).

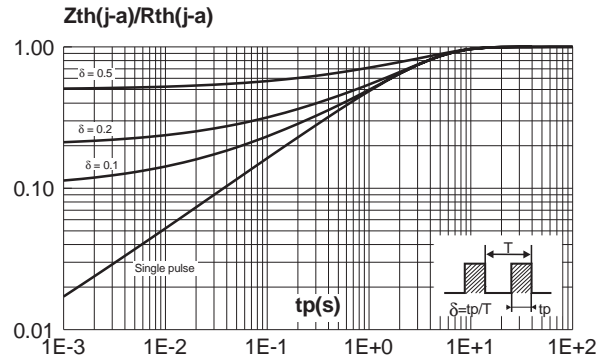

**Fig.5** : Reverse leakage current versus reverse voltage applied (typical values).

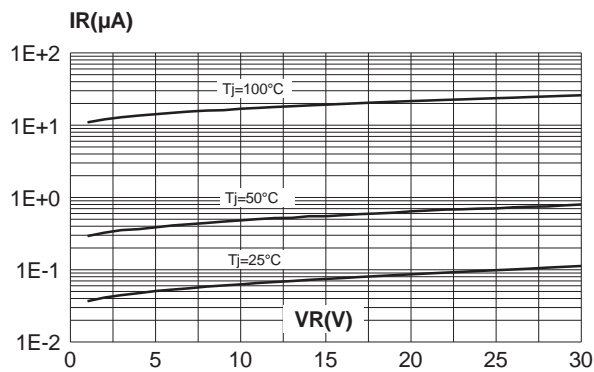

**Fig.6** : Reverse leakage current versus junction temperature.

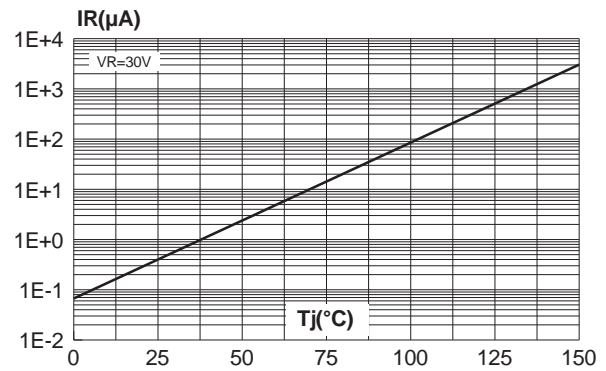

**Fig.7** : Junction capacitance versus reverse voltage applied (typical values).

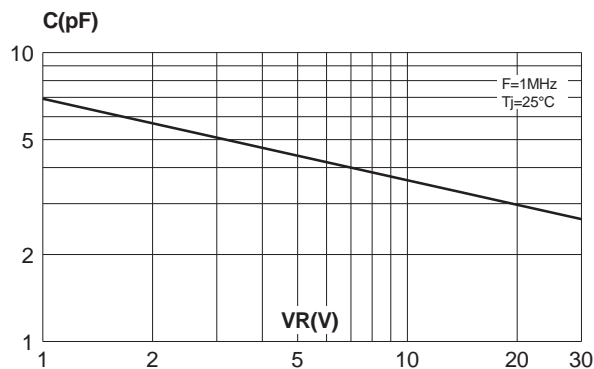

**Fig.8** : Forward voltage drop versus forward current (typical values).

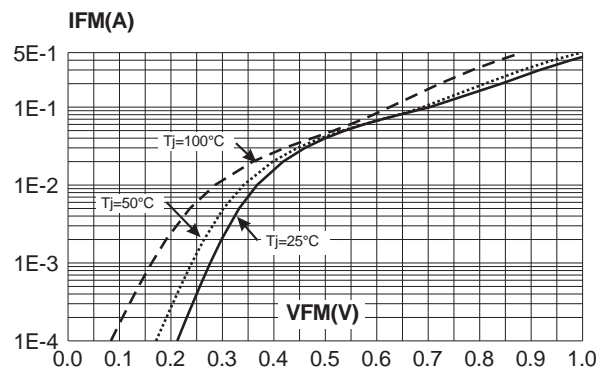

## BAT54, A, C, S

### PACKAGE MECHANICAL DATA SOT-23

	DIMENSIONS				
	REF.	Millimeters		Inches	
		Min.	Max.	Min.	Max.
	A	0.89	1.4	0.035	0.055
A1	0	0.1	0	0.004	
B	0.3	0.51	0.012	0.02	
c	0.085	0.18	0.003	0.007	
D	2.75	3.04	0.108	0.12	
e	0.85	1.05	0.033	0.041	
e1	1.7	2.1	0.067	0.083	
E	1.2	1.6	0.047	0.063	
H	2.1	2.75	0.083	0.108	
L	0.6 typ.		0.024 typ.		
S	0.35	0.65	0.014	0.026	

Ordering type	Marking	Package	Weight	Base qty	Delivery mode
BAT54FILM	D86	SOT-23	0.01g	3000	Tape & reel
BAT54AFILM	D84	SOT-23	0.01g	3000	Tape & reel
BAT54CFILM	D87	SOT-23	0.01g	3000	Tape & reel
BAT54SFILM	D88	SOT-23	0.01g	3000	Tape & reel

■ Epoxy meets UL94,V0

**FOOTPRINT DIMENSIONS**

COMPATIBLE SOT-23 / SC-59

(in millimeters and inches)

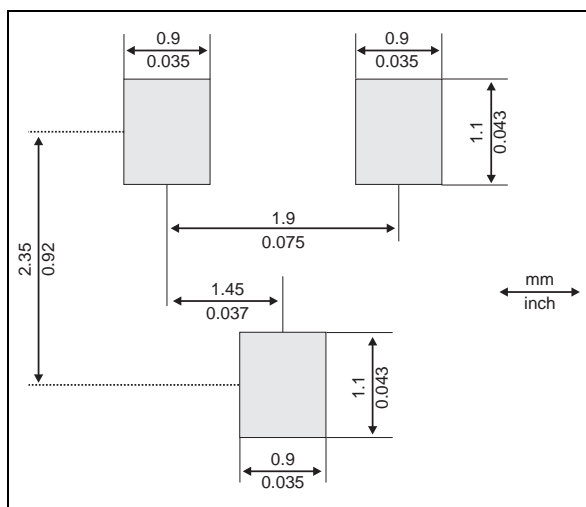

**OPTIMIZED SOT-23 FOOTPRINT DIMENSIONS**

(in millimeters and inches)

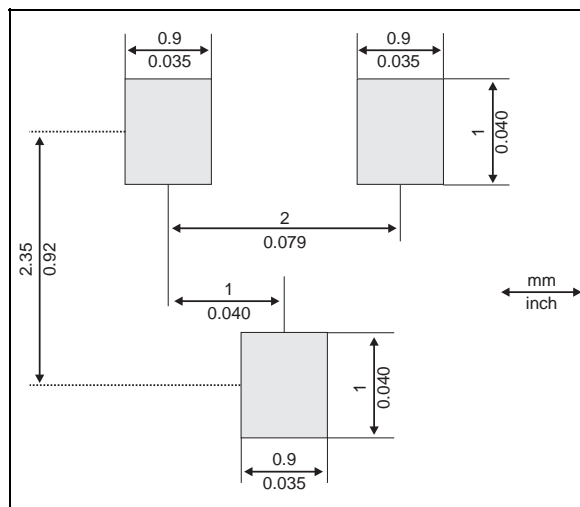

Information furnished is believed to be accurate and reliable. However, STMicroelectronics assumes no responsibility for the consequences of use of such information nor for any infringement of patents or other rights of third parties which may result from its use. No license is granted by implication or otherwise under any patent or patent rights of STMicroelectronics. Specifications mentioned in this publication are subject to change without notice. This publication supersedes and replaces all information previously supplied. STMicroelectronics products are not authorized for use as critical components in life support devices or systems without express written approval of STMicroelectronics.

The ST logo is a registered trademark of STMicroelectronics

© 1999 STMicroelectronics - Printed in Italy - All rights reserved.

STMicroelectronics GROUP OF COMPANIES

Australia - Brazil - China - Finland - France - Germany - Hong Kong - India - Italy - Japan - Malaysia  
 Malta - Morocco - Singapore - Spain - Sweden - Switzerland - United Kingdom - U.S.A.

<http://www.st.com>

