

SURFACE MOUNT LOW LEAKAGE DIODE

Features

- Ultra-Small Surface Mount Package
- Very Low Leakage Current
- **Lead Free/RoHS Compliant (Note 2)**
- **Qualified to AEC-Q101 Standards for High Reliability**

Mechanical Data

- Case: SOT-523
- Case Material: Molded Plastic. UL Flammability Classification Rating 94V-0
- Moisture sensitivity: Level 1 per J-STD-020C
- Terminals: Solderable per MIL-STD-202, Method 208
- Lead Free Plating (Matte Tin Finish annealed over Alloy 42 leadframe).
- Polarity: See Diagrams Below
- Marking: See Diagrams Below & Page 3
- Weight: 0.002 grams (approx.)
- Ordering Information: See Page 3

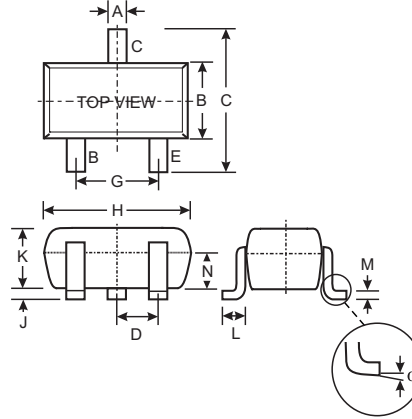

SOT-523			
Dim	Min	Max	Typ
A	0.15	0.30	0.22
B	0.75	0.85	0.80
C	1.45	1.75	1.60
D	—	—	0.50
G	0.90	1.10	1.00
H	1.50	1.70	1.60
J	0.00	0.10	0.05
K	0.60	0.80	0.75
L	0.10	0.30	0.22
M	0.10	0.20	0.12
N	0.45	0.65	0.50
alpha	0°	8°	—
All Dimensions in mm			

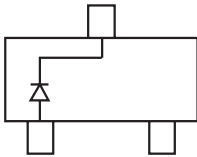

BAS116T Marking: 50

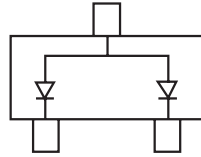

BAW156T Marking: 53

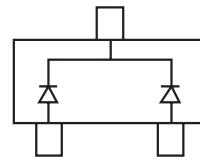

BAV170T Marking: 51

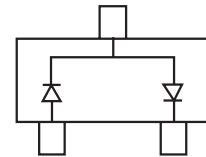

BAV199T Marking: 52

Maximum Ratings @ T_A = 25°C unless otherwise specified

Characteristic	Symbol	Value	Unit
Peak Repetitive Reverse Voltage Working Peak Reverse Voltage DC Blocking Voltage	V _{RRM} V _{RWM} V _R	85	V
RMS Reverse Voltage	V _{R(RMS)}	60	V
Forward Continuous Current (Note 1)	I _{FM}	215 125	mA
Repetitive Peak Forward Current	I _{FRM}	500	mA
Non-Repetitive Peak Forward Surge Current	I _{FSM}	4.0 1.0 0.5	A
Power Dissipation (Note 1)	P _d	150	mW
Thermal Resistance Junction to Ambient Air (Note 1)	R _{thetaJA}	833	°C/W
Operating and Storage Temperature Range	T _j , T _{STG}	-65 to +150	°C

- Notes: 1. Device mounted on FR-4 PC board with recommended pad layout, which can be found on our website at <http://www.diodes.com/datasheets/ap02001.pdf>.
2. No purposefully added lead.

Electrical Characteristics @ $T_A = 25^\circ\text{C}$ unless otherwise specified

Characteristic	Symbol	Min	Typ	Max	Unit	Test Condition
Reverse Breakdown Voltage (Note 3)	$V_{(BR)R}$	85	—	—	V	$I_R = 100\mu\text{A}$
Forward Voltage	V_F	—	—	0.90 1.0 1.1 1.25	V	$I_F = 1.0\text{mA}$ $I_F = 10\text{mA}$ $I_F = 50\text{mA}$ $I_F = 150\text{mA}$
Leakage Current (Note 3)	I_R	—	—	5.0 80	nA nA	$V_R = 75\text{V}$ $V_R = 75\text{V}, T_j = 150^\circ\text{C}$
Total Capacitance	C_T	—	2	—	pF	$V_R = 0, f = 1.0\text{MHz}$
Reverse Recovery Time	t_{rr}	—	—	3.0	μs	$I_F = I_R = 10\text{mA}$, $t_{rr} = 0.1 \times I_R, R_L = 100\Omega$

Notes: 3. Short duration test pulse used to minimize self-heating effect.

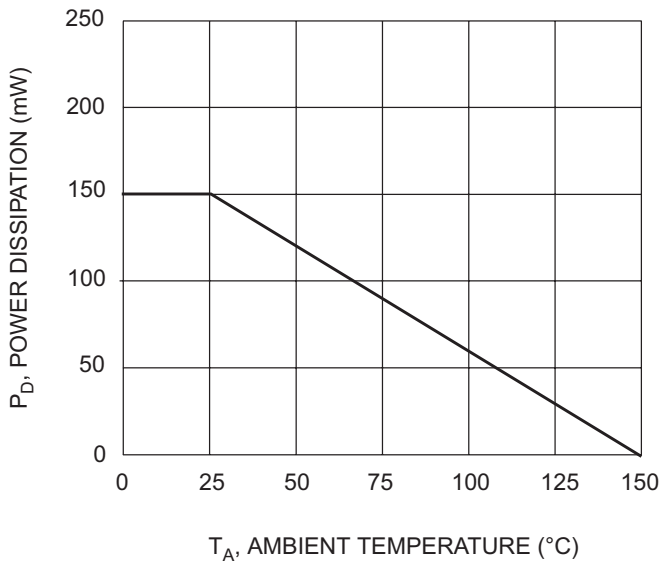

T_A , AMBIENT TEMPERATURE ($^\circ\text{C}$)
Fig. 1 Power Derating Curve

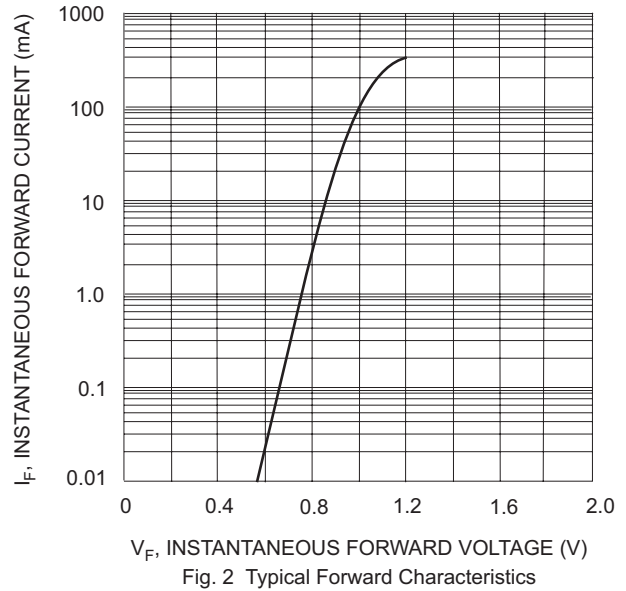

V_F , INSTANTANEOUS FORWARD VOLTAGE (V)
Fig. 2 Typical Forward Characteristics

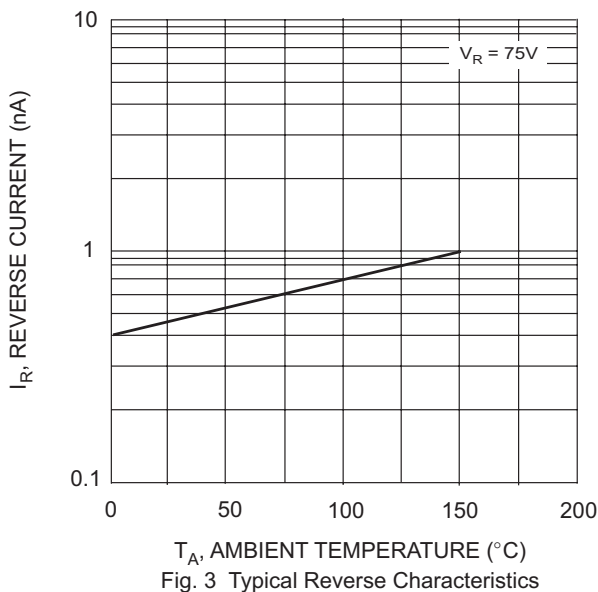

T_A , AMBIENT TEMPERATURE ($^\circ\text{C}$)
Fig. 3 Typical Reverse Characteristics

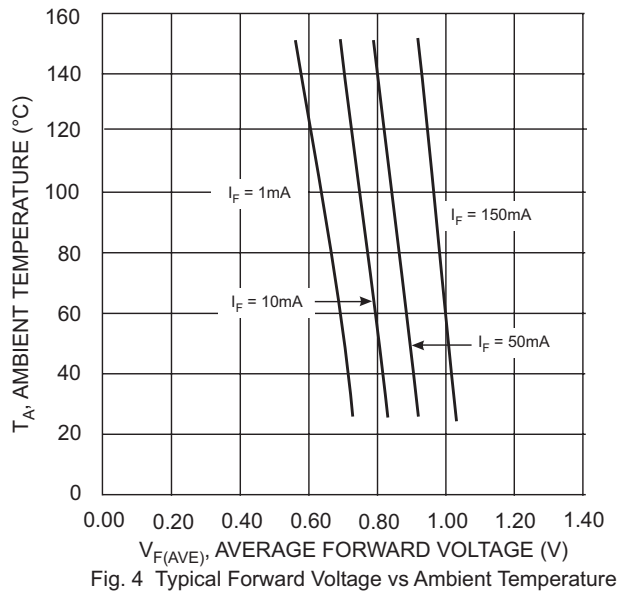

$V_{F(AVE)}$, AVERAGE FORWARD VOLTAGE (V)
Fig. 4 Typical Forward Voltage vs Ambient Temperature

Ordering Information (Note 4)

Device	Packaging	Shipping
BAS116T-7-F	SOT-523	3000/Tape & Reel
BAW156T-7-F	SOT-523	3000/Tape & Reel
BAV170T-7-F	SOT-523	3000/Tape & Reel
BAV199T-7-F	SOT-523	3000/Tape & Reel

Notes: 4. For Packaging Details, go to our website at <http://www.diodes.com/datasheets/ap02007.pdf>.

Marking Information

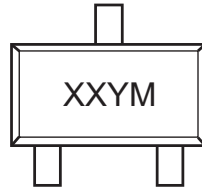

XX = Product Type Marking Code (See Page 1, e.g. 50 = BAS116T)
 YM = Date Code Marking
 Y = Year (ex: N = 2002)
 M = Month (ex: 9 = September)

Date Code Key

Year	2001	2002	2003	2004	2005	2006	2007	2008	2009	2010	2011	2012
Code	M	N	P	R	S	T	U	V	W	X	Y	Z

Month	Jan	Feb	March	Apr	May	Jun	Jul	Aug	Sep	Oct	Nov	Dec
Code	1	2	3	4	5	6	7	8	9	O	N	D

IMPORTANT NOTICE

Diodes Incorporated and its subsidiaries reserve the right to make modifications, enhancements, improvements, corrections or other changes without further notice to any product herein. Diodes Incorporated does not assume any liability arising out of the application or use of any product described herein; neither does it convey any license under its patent rights, nor the rights of others. The user of products in such applications shall assume all risks of such use and will agree to hold Diodes Incorporated and all the companies whose products are represented on our website, harmless against all damages.

LIFE SUPPORT

Diodes Incorporated products are not authorized for use as critical components in life support devices or systems without the expressed written approval of the President of Diodes Incorporated.